

2-Color Display High-Precision Digital Pressure Switch

ZSE30A(F)/ISE30A Series

The ZSE30A(F)/ISE30A series now features 2 new models: the ZSE20(F)/ISE20 and the ZSE20A(F)/ISE20A. Click [here](#) for details.



Can copy to up to 10 switches simultaneously.

The settings of the master sensor can be copied to the slave sensors.

- Reducing setting labor
- Minimizing risk of mistakes in setting

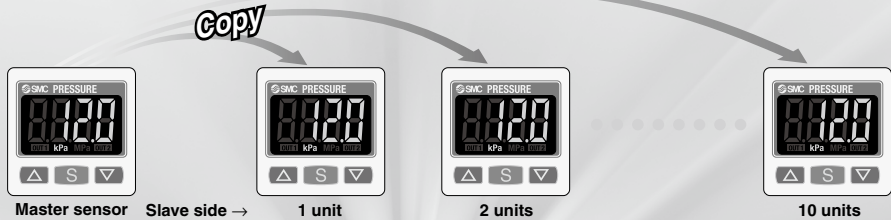

3-step setting

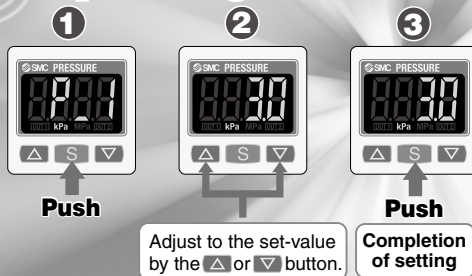

ZSE20
ISE20
ZSE30
ISE30
ZSE40
ISE40
ZSE10
ISE10
ISE70
ZSE80
ISE80
PS
ISA3
ISA2
ISE35
PSE
IS
ISG
ZSM1



Added vacuum range.

- Rated pressure range: 0.0 to -101.0 kPa

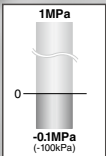

Expanded pressure range for positive-pressure type to the vacuum range.

- Rated pressure range: -0.100 to 1.000 MPa



2 added outputs

- NPN or PNP open collector 2 outputs
- NPN or PNP open collector 1 output + Analog output (1 to 5 V or 4 to 20 mA)

Mounting

Bracket configuration allows mounting in four orientations.

Bracket A

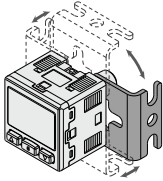

Bracket B/C

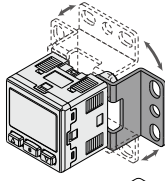

Bracket B
Mounting
example

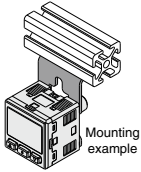
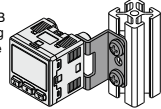

Mounting
example

Bracket C
Mounting
example

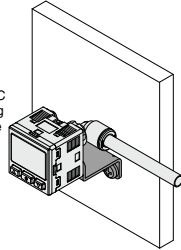

Panel mount

Mountable side by side without clearance

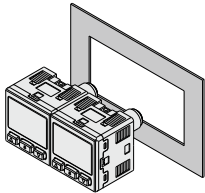

One opening!

- Reduced panel fitting labor
- Space-saving

Series

Series ZSE30A (vacuum) ZSE30AF (compound) ISE30A (positive)

	ZSE30A (vacuum)	ZSE30AF (compound)	ISE30A (positive)
Rated pressure range	0.0 to -101.0 kPa 	-100.0 to 100.0 kPa 	-0.100 to 1.000 MPa 1 MPa
Set pressure range	-10.0 to -105.0 kPa	-105.0 to 105.0 kPa	-0.105 to 1.050 MPa
Withstand pressure	500 kPa	500 kPa	1.5 MPa
Minimum unit setting	0.1 kPa	0.1 kPa	0.001 MPa
Output	NPN or PNP open collector 1 output NPN or PNP open collector 2 outputs NPN or PNP open collector 1 output + Analog output (voltage or current)		
Piping	R1/8, NPT1/8 (M5 female threaded) ø4, ø6, ø5/32, ø1/4 One-touch fittings		

Replaceable One-touch fittings

The clip type allows easy removal of fittings. Fitting's type and size can be changed.

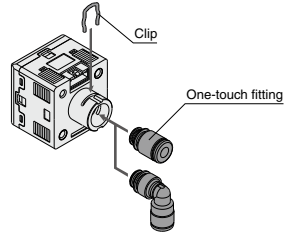

Lead wire

Added the connector cover.

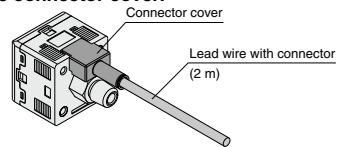

4-digit display

4-digit display allows easy reading of displayed values.

Example: 0.5 MPa



30A Series
(New)



30 Series
(Current)

Possible to check set-value during key locking

Additional functions

◆ Secret code setting function

The key locking function keeps unauthorized persons from tampering with buttons.

◆ Power-saving function

Power consumption is reduced by turning off the monitor. (Reduce power consumption by up to 20%.)

◆ Resolution-switch function

It reduces the monitor to flicker.



1/1000



1/100

(Accuracy is not changed, only the displayed values.)

◆ MPa/kPa switch function

Vacuum, compound and/or positive pressure can be displayed in MPa or kPa.



MPa



kPa

2-Color Display High-Precision Digital Pressure Switch ZSE30A(F)/ISE30A Series



RoHS



How to Order

The ZSE30A(F)/ISE30A series now features 2 new models: the ZSE20(F)/ISE20 and the ZSE20A(F)/ISE20A. Click [here](#) for details.

ZSE20
ISE20

ZSE30
ISE30

ZSE40
ISE40

ZSE10
ISE10

ISE70

ZSE80
ISE80

PS

ISA3

ISA2

ISE35

PSE

IS

ISG

ZSM1

Output specifications

N	NPN open collector 1 output
P	PNP open collector 1 output
A	NPN open collector 2 outputs
B	PNP open collector 2 outputs
C*	NPN open collector 1 output + Analog voltage output
D*	NPN open collector 1 output + Analog current output
E*	PNP open collector 1 output + Analog voltage output
F*	PNP open collector 1 output + Analog current output

* Made to Order

Made to Order (P.43)

Symbol	Specifications/Description
X510	For M12 4-pin pre-wired connector

Available only for output specifications "A", "B", and option 1 "G".

Option 3

Symbol	Operation manual	Calibration certificate
Nil	<input type="radio"/>	<input type="radio"/>
Y	<input type="radio"/>	<input type="radio"/>
K	<input type="radio"/>	<input type="radio"/>
T	<input type="radio"/>	<input type="radio"/>

Note) All texts in both English and Japanese.

Option 2

Nil	None
A1	Bracket A
A2	Bracket B
A3	Bracket C
B	Panel mount adapter
D	Panel mount adapter + Front protection cover

Rated pressure range

ISE30A -0.1 to 1 MPa

ISE30A - 01 - N - M

For positive pressure

For vacuum/
compound pressure

ZSE30A - 01 - N - M

Rated pressure range

ZSE30A	0 to -101 kPa
ZSE30AF	-100 to 100 kPa

Piping specifications

01	R1/8 (M5 female threaded)	
N01	NPT1/8 (M5 female threaded)	
C4H	One-touch fitting ø4 mm, ø5/32 inch	Straight type
C6H	One-touch fitting ø6 mm	
N7H	One-touch fitting ø1/4 inch	
C4L	One-touch fitting ø4 mm, ø5/32 inch	Elbow type
C6L	One-touch fitting ø6 mm	
N7L	One-touch fitting ø1/4 inch	

Unit specifications

Nil	With display unit switching function (Note 1)
M	Fixed SI unit (Note 2)
P*	With display unit switching function (Initial value psi)

* Made to Order

Note 1) Under the New Measurement Law, sales of switches with the unit switching function have not been allowed for use in Japan.

Note 2) Unit: kPa, MPa

Option 1

Nil	Without lead wire
L	Lead wire with connector (Lead wire length 2 m) (Note)
G	Lead wire with connector (Lead wire length 2 m) (Note) With connector cover

Note) For output types N and P, the number of core of lead wires will be 3, and for other types, it will be 4.

ZSE30A(F)/ISE30A Series

Refer to pages 11 and 12 for Pressure Switch Precautions. For details about the Specific Product Precautions, refer to the Operation Manual on the SMC website, <http://www.smcworld.com> Click [here](#) for details.

Specifications

Model	ZSE30A (Vacuum pressure)	ZSE30AF (Compound pressure)	ISE30A (Positive pressure)
Rated pressure range	0.0 to -101.0 kPa	-100.0 to 100.0 kPa	-0.100 to 1.000 MPa
Display/Set pressure range	10.0 to -105.0 kPa	-105.0 to 105.0 kPa	-0.105 to 1.050 MPa
Withstand pressure	500 kPa	500 kPa	1.5 MPa
Display/Minimum unit setting	0.1 kPa	0.1 kPa	0.001 MPa
Applicable fluid	Air, Non-corrosive gas, Non-flammable gas		
Power supply voltage	12 to 24 VDC $\pm 10\%$, Ripple (p-p) 10% or less (with power supply polarity protection)		
Current consumption	40 mA or less		
Switch output	NPN or PNP open collector 1 output, NPN or PNP open collector 2 outputs		
Maximum load current	80 mA		
Maximum applied voltage	28 V (at NPN output)		
Residual voltage	1 V or less (with load current of 80 mA)		
Response time	2.5 ms or less (with anti-chattering function: 20, 100, 500, 1000, 2000 ms)		
Short circuit protection	Yes		
Repeatability	$\pm 0.2\%$ F.S. ± 1 digit		
Hysteresis	Variable (0 or above) ^{Note 1)}		
Hysteresis	Window comparator mode		
Output voltage (Rated pressure range)	1 to 5V $\pm 2.5\%$ F.S.		0.6 to 5 V $\pm 2.5\%$ F.S.
Linearity	$\pm 1\%$ F.S.		
Output impedance	Approx. 1 k Ω		
Output current (Rated pressure range)	4 to 20 mA $\pm 2.5\%$ F.S.		2.4 to 20 mA $\pm 2.5\%$ F.S.
Linearity	$\pm 1\%$ F.S.		
Load impedance	Maximum load impedance: Power supply voltage 12 V: 300 Ω , Power supply voltage 24 V: 600 Ω Minimum load impedance: 50 Ω		
Display	4-digit, 7-segment, 2-color LCD (Red/Green)		
Display accuracy	$\pm 2\%$ F.S. ± 1 digit (Ambient temperature of 25 $\pm 3^\circ\text{C}$)		
Indicator light	Lights up when switch output is turned ON. OUT1: Green, OUT2: Red		
Enclosure	IP40		
Operating temperature range	Operating: 0 to 50°C, Stored: -10 to 60°C (No freezing or condensation)		
Operating humidity range	Operating/Stored: 35 to 85% RH (No condensation)		
Withstand voltage	1000 VAC for 1 minute between terminals and housing		
Insulation resistance	50 M Ω or more (500 VDC measured via megohmmeter) between terminals and housing		
Temperature characteristics	$\pm 2\%$ F.S. (25°C reference)		
Lead wire with connector	Oilproof heavy-duty vinyl cable, 3 cores $\phi 3.5, 2$ m 4 cores Conductor area: 0.15 mm ² (AWG26), Insulator O.D.: 1.0 mm		
Standards	CE, UL/CSA (E216656), RoHS		

Note 1) If applied pressure fluctuates near the set value, set the hysteresis above the fluctuation range to prevent chattering.

Note 2) When analog voltage output is selected, analog current output cannot be used together.

Note 3) When analog current output is selected, analog voltage output cannot be used together.

Piping Specifications

Model	01	N01	C4H	C6H	N7H	C4L	C6L	N7L
Port size	R1/8 M5 x 0.8	NPT1/8 M5 x 0.8	—	—	—	—	—	—
One-touch fitting, Straight type	—	—	$\phi 4$ mm $\phi 5/32$ inch	$\phi 6$ mm	$\phi 1/4$ inch	—	—	—
One-touch fitting, Elbow type	—	—	—	—	—	$\phi 4$ mm $\phi 5/32$ inch	$\phi 6$ mm	$\phi 1/4$ inch
Wetted parts material	Sensor pressure receiving area: Silicon							
Piping port	C3602 (electroless nickel plating) O-ring: HNBR		PBT, POM, Stainless steel 304, C3604 (electroless nickel plating) O-ring: NBR					
Weight	Including lead wire with connector (3 cores, 2 m)	81 g	70 g	71 g	73 g	75 g	73 g	75 g
	Including lead wire with connector (4 cores, 2 m)	85 g	74 g	75 g	77 g	79 g	77 g	79 g
	Excluding lead wire with connector	43 g	32 g	33 g	35 g	37 g	35 g	37 g

Option/Part No.

When optional parts are required separately, use the following part numbers to place an order.

Part no.	Option	Note	Part no.	Option	Note
ZS-38-A1	Bracket A	Mounting screw (with 2 pcs. of M3 x 5L)	ZS-38-4G	Lead wire with connector (with connector cover)	4 cores, for 2 outputs, 2 m
ZS-38-A2	Bracket B	Mounting screw (with 2 pcs. of M3 x 5L)	ZS-38-5L	Lead wire with a connector for copying	3 cores, copy function, 1 m
ZS-38-A3	Bracket C	Mounting screw (with 2 pcs. of M3 x 5L)	ZS-38-U	Lead wire unit with a connector for copying	Copy function (up to 10 slaves)
ZS-27-C	Panel mount adapter	Mounting screw (with 2 pcs. of M3 x 8L)	ZS-38-C4H	One-touch fittings $\phi 4$ mm straight	O-ring, one-touch clip included
ZS-27-D	Panel mount adapter + Front protection cover	Mounting screw (with 2 pcs. of M3 x 8L)	ZS-38-C6H	One-touch fittings $\phi 6$ mm straight	O-ring, one-touch clip included
ZS-27-01	Front protection cover		ZS-38-N7H	One-touch fittings $\phi 1/4$ inch straight	O-ring, one-touch clip included
ZS-38-3L	Lead wire with connector	3 cores, for 1 output, 2 m	ZS-38-C4L	One-touch fittings $\phi 4$ mm elbow	O-ring, one-touch clip included
ZS-38-4L	Lead wire with connector	4 cores, for 2 outputs, 2 m	ZS-38-C6L	One-touch fittings $\phi 6$ mm elbow	O-ring, one-touch clip included
ZS-38-3G	Lead wire with connector (with connector cover)	3 cores, for 1 output, 2 m	ZS-38-N7L	One-touch fittings $\phi 1/4$ inch elbow	O-ring, one-touch clip included

Set Pressure Range and Rated Pressure Range

Set the pressure within the rated pressure range.

The set pressure range is the range of pressure that is possible in setting.

The rated pressure range is the range of pressure that satisfies the specifications (accuracy, linearity, etc.) on the switch.

Although it is possible to set a value outside the rated pressure range, the specifications will not be guaranteed even if the value stays within the set pressure range.

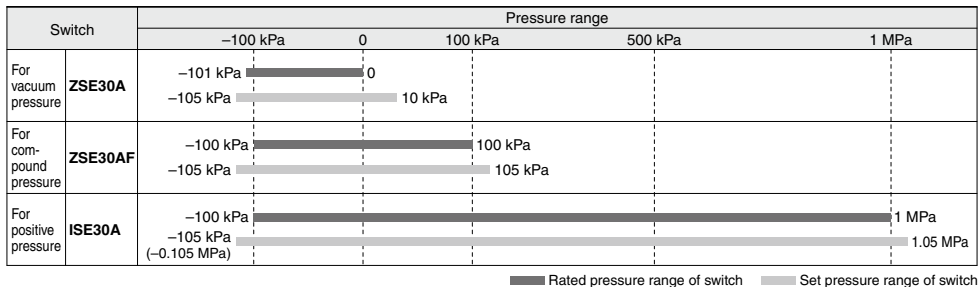

Analog Output

Voltage output

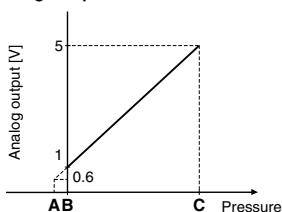

Current output

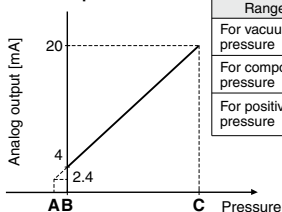

Range	Rated pressure range	A	B	C
For vacuum pressure	0.0 to -101.0 kPa	—	0	-101 kPa
For compound pressure	-100.0 to 100.0 kPa	—	-100 kPa	100 kPa
For positive pressure	-0.100 to 1.000 MPa	-0.1 MPa	0	1 MPa

Functions (Refer to pages 41 and 42 for details.)

Copy function	Copies the settings of the master sensor to the slave sensors.
Auto-preset function	This function is to calculate a rough set-value automatically based on the on-going operation.
Display calibration function	Evens out deviations in the displayed value.
Peak display function	Can retain the maximum pressure value displayed during measurement.
Bottom display function	Can retain the minimum pressure value displayed during measurement.
Keylock function (Selectable secret code)	The key board can be locked to prevent any incorrect function of the operation switch.
Zero-clear function	The pressure display can be set at zero when the pressure is open to the atmosphere.
Anti-chattering function	Prevents possible malfunction due to sudden fluctuations in the primary pressure by adjusting the response time.
Unit display switching function	Can convert the display value.
Power-saving mode	Reduces power consumption.
Display resolution-switch function	Converts display resolution from the normal value of 1/1000 to 1/100. It reduces the monitor to flicker.
kPa ↔ MPa switch function	Converts the unit between kPa and MPa.

ZSE30A(F)/ISE30A Series

Internal Circuits and Wiring Examples

-N NPN (1 output)

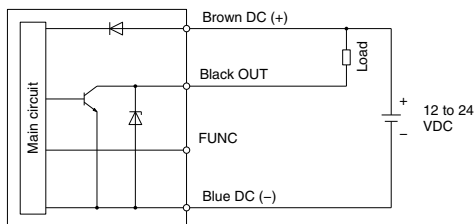

-P PNP (1 output)

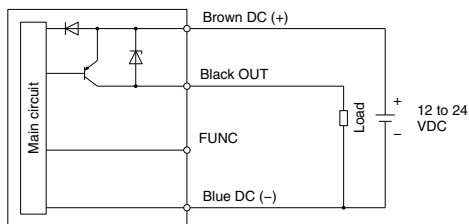

-A NPN (2 outputs)

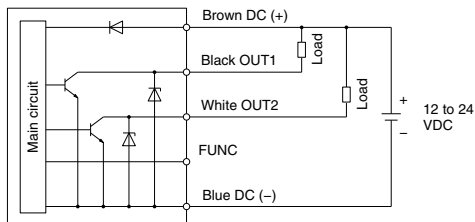

-B PNP (2 outputs)

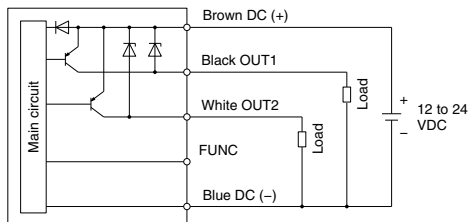

-C NPN (1 output) + Analog voltage output

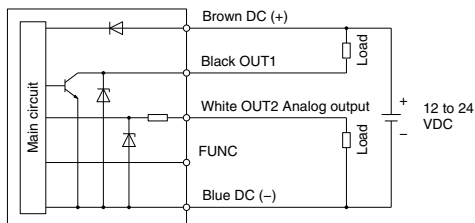

-D NPN (1 output) + Analog current output

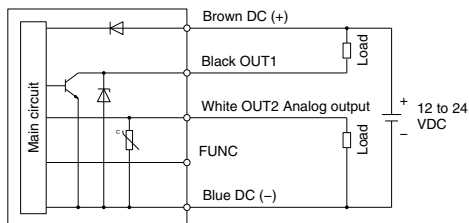

-E PNP (1 output) + Analog voltage output

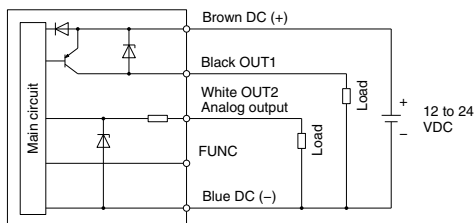

-F PNP (1 output) + Analog current output

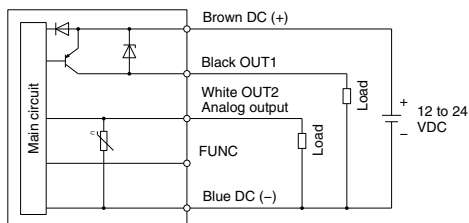

* The FUNC terminal is connected when using the copy function. (Refer to "Copy function" on page 41.)

Dimensions

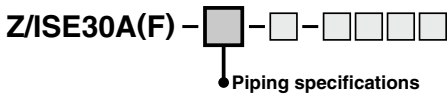

01 / N01

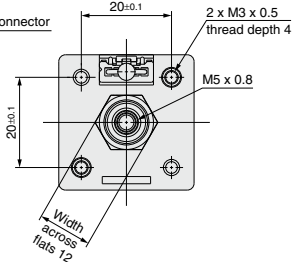
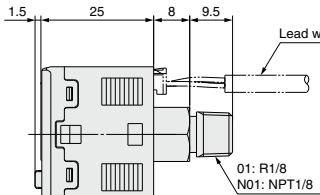
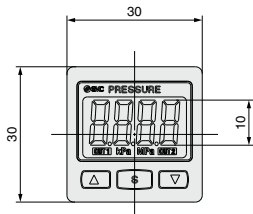

C4H

One-touch fitting $\varnothing 4$ mm
 $\varnothing 5/32$ inch straight

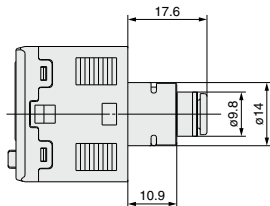

C6H

One-touch fitting $\varnothing 6$ mm
straight

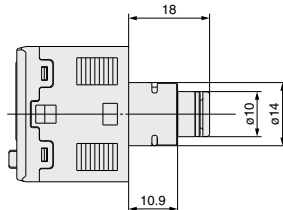

N7H

One-touch fitting $\varnothing 1/4$ inch
straight

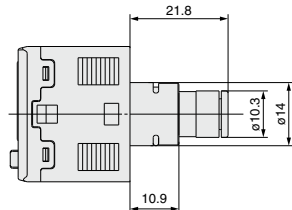

C4L

One-touch fitting $\varnothing 4$ mm
 $\varnothing 5/32$ inch elbow

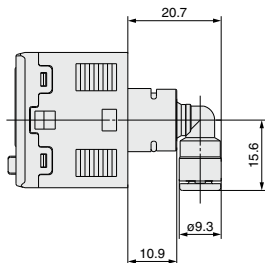

C6L

One-touch fitting $\varnothing 6$ mm
elbow

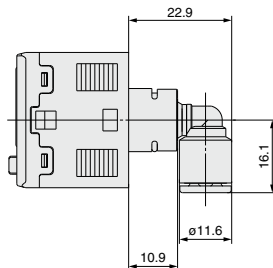

N7L

One-touch fitting $\varnothing 1/4$ inch
elbow

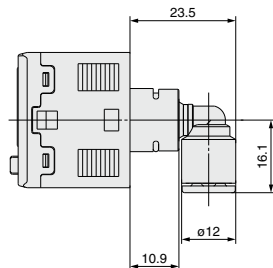

ZSE20
ISE20
ZSE30
ISE30
ZSE40
ISE40
ZSE10
ISE10
ISE70
ZSE80
ISE80
PS
ISA3
ISA2
ISE35
PSE
IS
ISG
ZSM1

ZSE30A(F)/ISE30A Series

Dimensions

With bracket

Z/ISE30A(F) - □ - □ - □ - □ - □

Option 2

A1

Bracket A
(Option unit part no.: ZS-38-A1)

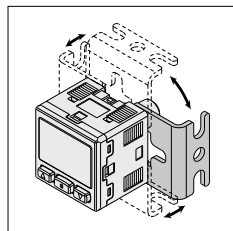
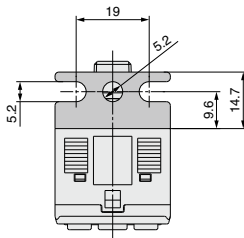
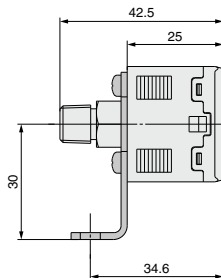
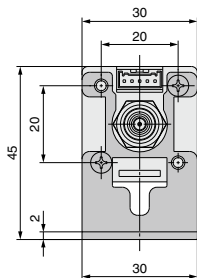

* Bracket configuration allows mounting in four orientations.

A2

Bracket B
(Option unit part no.: ZS-38-A2)

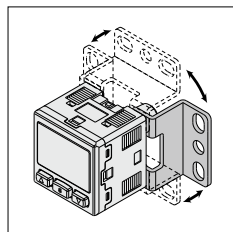
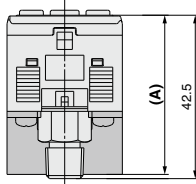

* Bracket configuration allows mounting in four orientations.

A3

Bracket C
(Option unit part no.: ZS-38-A3)

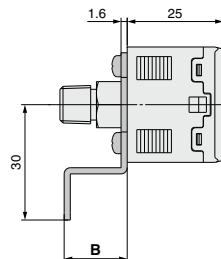
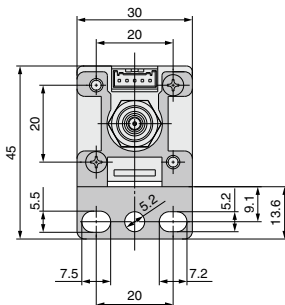

	A	B
Bracket B	41.4	16.4
Bracket C	53	28

* When using the bracket B or C, install it by taking the dimensions of the piping part into consideration.

Panel mount adapter

Z/ISE30A(F) - □ - □ - □ - □ - □

Option 2

B

Panel mount adapter
(Option unit part no.: ZS-27-C)

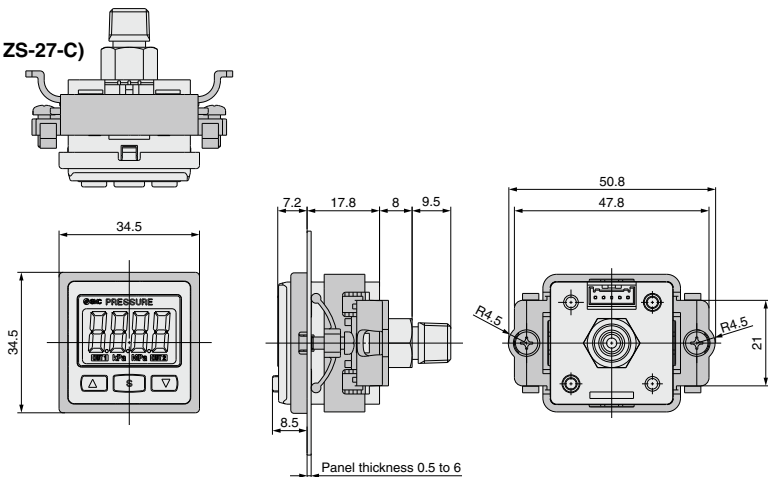

D

Panel mount adapter + Front protection cover
(Option unit part no.: ZS-27-D)

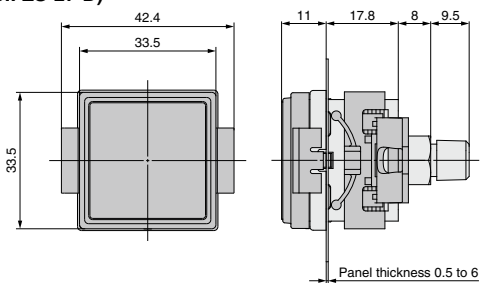

Lead wire with connector
(Option unit part no.: ZS-38-3L)

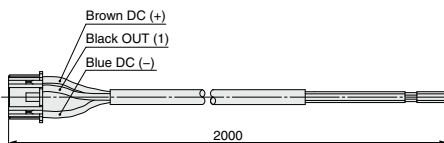

(Option unit part no.: ZS-38-4L)

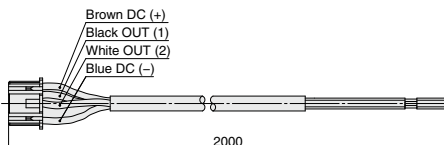

ZSE20
ISE20
ZSE30
ISE30
ZSE40
ISE40
ZSE10
ISE10
ISE70
ZSE80
ISE80
PS
ISA3
ISA2
ISE35
PSE
IS
ISG
ZSM1

ZSE30A(F)/ISE30A Series

Dimensions

Panel fitting dimensions

1 pc. mounting

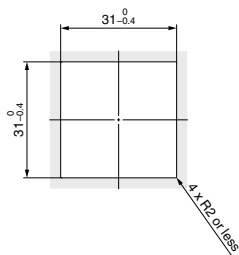

Multiple (2 pcs. or more) horizontal mounting

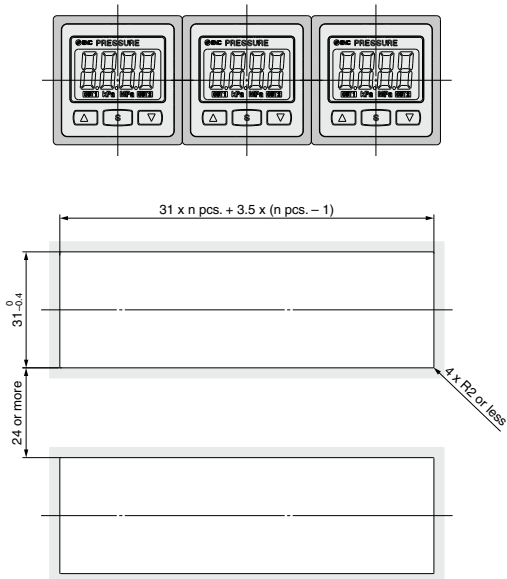

Multiple (2 pcs. or more) vertical mounting

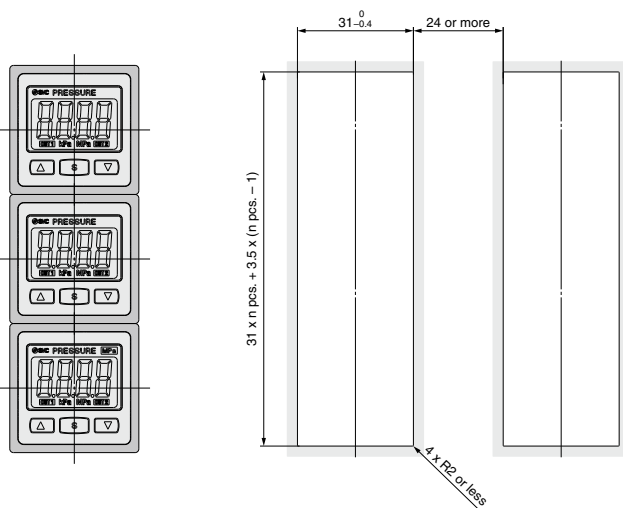

The **F□** in () shows the function code number. Refer to the Operation Manual for the details of operation procedures and function codes. Click [here](#) for details.

Function Details

A Copy function (F97)

The settings of the master sensor can be copied to the slave sensors, reducing setting labor and minimizing risk of mistakes in setting.

Can copy to up to 10 switches simultaneously.
(Maximum transmission distance 4 m)

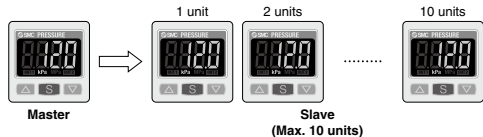

- 1) The sensors are connected by a dedicated lead wire (ZS-38-5L (for master and one slave) or ZS-38-U (for master and up to 10 slaves)). Copying is performed through a dedicated communication line.
- 2) Select the slave switch which is to be the master, and change it into a master using the buttons. (In the default setting, all switches are set as slaves.)
- 3) Press the **[S]** button of the master switch to start copying.

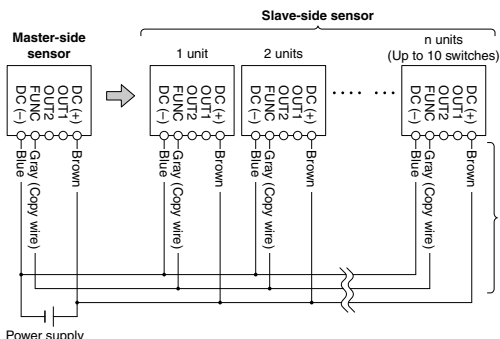

Wiring example when using ZS-38-U

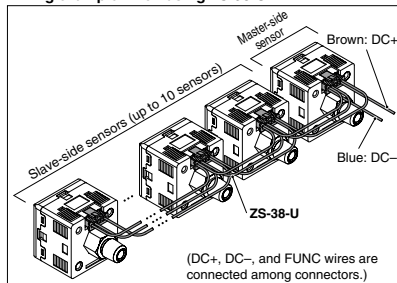

B Auto-preset function (F5)

Auto-preset function, when selected in the initial setting, calculates and stores the set-value from the measured pressure. The optimum set-value is determined automatically by repeating vacuum and break with the target workpiece several times.

Suction Verification

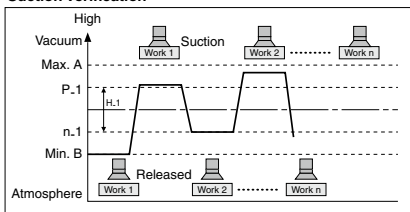

Formula for Obtaining the Set-Value

P ₁ or P ₂	H ₁ or H ₂
$P_1 (P_2) = A - (A-B)/4$	$H_1 (H_2) = I (A-B)/2!$
$n_1 (n_2) = B + (A-B)/4$	

C Display calibration function (F6)

Fine adjustment of the indicated value of the pressure sensor can be made within the range of $\pm 5\%$ of the read value.

(The scattering of the indicated value can be eliminated.)

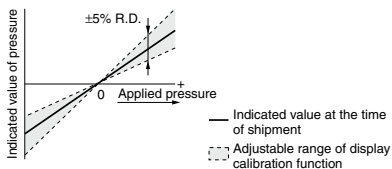

Note) When the display calibration function is used, the set pressure value may change ± 1 digit.

D Peak/Bottom value indication

This function constantly detects and updates the maximum (minimum) value and allows to hold the maximum (minimum) pressure value.

When the **[Δ]** **[▽]** buttons are simultaneously pressed for 1 second or longer, while "holding", the held value will be reset.

E Keylock function

Prevents operation errors such as accidentally changing setting values.

F Zero-clear function

This function clears and resets the zero value on the display of measured pressure.

For the pressure switch with analog output, the analog output shifts according to the indication. The indicated value can be adjusted within $\pm 7\%$ F.S. of the pressure when ex-factory. (ZSE30AF (for compound pressure) $\pm 3.5\%$ F.S.)

ZSE20
ISE20
ZSE30
ISE30
ZSE40
ISE40
ZSE10
ISE10
ISE70
ZSE80
ISE80
PS
ISA3
ISA2
ISE35
PSE
IS
ISG
ZSM1

ZSE30A(F)/ISE30A Series

The F□ in () shows the function code number. Refer to the Operation Manual for the details of operation procedures and function codes. Click [here](#) for details.

Function Details

G Error indication function

Error name	Error code	Description	Action
Overcurrent error	Er 1	Load current of 80 mA or more is applied to the switch output (OUT1).	Eliminate the cause of the over current by turning off the power supply, and then turn on it again.
	Er 2	Load current of 80 mA or more is applied to the switch output (OUT2).	
Residual pressure error	Er 3	During zero-clear operation, pressure over $\pm 7\%$ F.S. is applied. (ZSE30AF (compound) $\pm 3.5\%$ F.S.) After 1 second, the mode will reset to measurement mode. $\pm 1\%$ F.S. of the zero-clear range varies between individual products.	Perform zero-clear operation again after restoring the applied pressure to an atmospheric pressure condition.
Applied pressure error	HHH	Supply pressure exceeds the maximum set pressure.	Reset applied pressure to a level within the set pressure range.
	LLL	Supply pressure is below the minimum set pressure.	
System error	Er 0	Internal data error	Turn off the power supply and then turn on it again. If the failure cannot be solved, please contact SMC for investigation.
	Er 4		
	Er 6		
	Er 7		
	Er 8		
	Er 9		

If the failure cannot be solved after the above instructions are performed, please contact SMC for investigation.

H Anti-chattering function (F3)

A large bore cylinder or ejector consumes a large volume of air in operation and may experience a temporary drop in the supply pressure. This function prevents detection of such temporary drops in the supply pressure as an error.

Available response time settings
20 ms, 100 ms, 500 ms, 1000 ms, 2000 ms

<Principle>

This function averages pressure values measured during the response time set by the user and then compares the average pressure value with the pressure set point value to output the result on the switch.

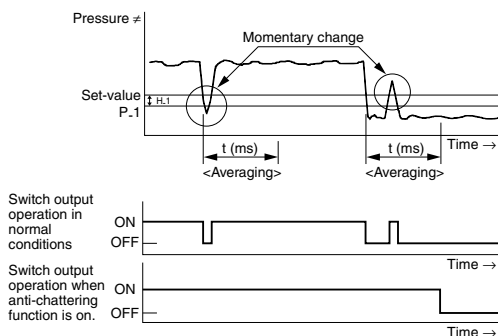

I Display unit switching function (F0)

Display units can be switched with this function.

Display unit Min. unit setting	PA		GF	bAr	PSi	inH	mmH
	kPa	MPa*	kg/cm ²	bar	psi	inHg	mmHg
ZSE30A (Vacuum pressure)	0.1	0.001	0.001	0.001	0.01	0.1	1
ZSE30AF (Compound pressure)	0.1	0.001	0.001	0.001	0.01	0.1	1
ISE30A (Positive pressure)	1	0.001	0.01	0.01	0.1	/	/

* The ZSE30A (vacuum pressure) and ZSE30AF (compound pressure) will have different setting and display resolution when the unit is set to MPa.

J Power-saving mode (F7)

Power-saving mode can be selected.

It shifts to the power-saving mode without button operation for 30 seconds. It is set to the normal mode (Power-saving mode is OFF.) when ex-factory. (Decimal points and operation indicator light (only when the switch output is turned ON.) blink in the power-saving mode.)

K Setting of secret code (F8)

Users can select whether a secret code must be entered to release key lock. At the time of shipment from the factory, it is set such that the secret code is not required.

ZSE30A(F)/ISE30A Series

Made to Order

Please contact SMC for detailed dimensions, specifications and lead times.



1 M12 4-pin Pre-wired Connector (Lead wire length 100 mm)

X510

How to Order

* Refer to "How to Order" on page 33 for standard specifications.

ZSE30A(F)/ISE30A - [] - [] - [] G [] - X510

Piping specifications*

Option*

Output specifications

A: NPN open collector 2 outputs

B: PNP open collector 2 outputs

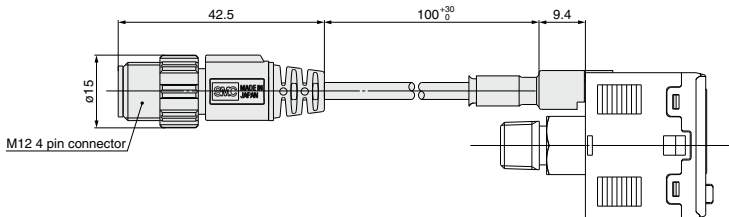

Option cable ZS-38-4GM12

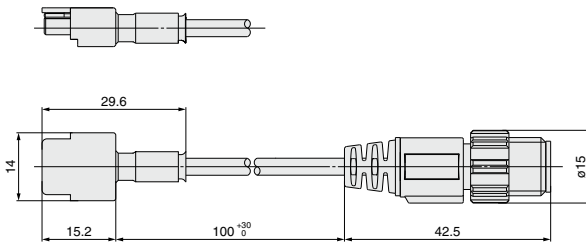

Connector pin numbers

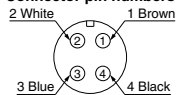

Pin no.	Pin description
1	DC (+)
2	OUT (2)
3	DC (-)
4	OUT (1)

ZSE20
ISE20
ZSE30
ISE30
ZSE40
ISE40
ZSE10
ISE10
ISE70
ZSE80
ISE80
PS
ISA3
ISA2
ISE35
PSE
IS
ISG
ZSM1