

For Water

Digital Flow Switch

Series PF2W CE

How to Order



Integrated Display Type

PF2W7 20 - 03 - 27 - M

Flow rate range

04	0.5 to 4 L/min
20	2 to 16 L/min
40	5 to 40 L/min
11	10 to 100 L/min

Thread type

Nil	Rc
N	NPT
F	G

Port size

Symbol	Port size	Flow rate (L/min)				Applicable model
		4	16	40	100	
03	3/8	●	●			PF2W704, PF2W720
04	1/2		●	●		PF2W720, PF2W740
06	3/4			●	●	PF2W740, PF2W711
10	1				●	PF2W711

Unit specifications

Nil	With unit switching function (Note1)
M	Fixed SI unit (Note2)

Note1) Under Japan's new Measurement Act, this is only for overseas sales (SI units are to be used inside Japan).

Note2) Fixed units: Instantaneous flow rate: L/min
Accumulated flow: L

Lead wire (Refer to page 322.)

Nil	Lead wire with M12 connector (3 m)
N	Without lead wire

Output specifications

27	NPN open collector 2 outputs
67	PNP open collector 2 outputs

Specifications

Model	PF2W704	PF2W720	PF2W740	PF2W711
Measured fluid	Water			
Flow rate measurement range	0.35 to 4.5 L/min	1.7 to 17.0 L/min	3.5 to 45 L/min	7 to 110 L/min
Set flow rate range	0.35 to 4.5 L/min	1.7 to 17.0 L/min	3.5 to 45 L/min	7 to 110 L/min
Rated flow range	0.5 to 4 L/min	2 to 16 L/min	5 to 40 L/min	10 to 100 L/min
Minimum set unit	0.05 L/min	0.1 L/min	0.5 L/min	1 L/min
Accumulated pulse flow rate exchange value (Pulse width: 50 ms)	0.05 L/pulse	0.1 L/pulse	0.5 L/pulse	1 L/pulse
Operating fluid temperature	0 to 50°C			
Accuracy	±5% F.S.			±3% F.S.
Repeatability	±3% F.S.			±2% F.S.
Temperature characteristics (Note 1)	±5% F.S. (0 to 50°C, 25°C reference)			
Current consumption (No load)	70 mA or less			80 mA or less
Weight (Note 2)	460 g	520 g	700 g	1150 g
Port size (Rc, NPT, G)	3/8	3/8, 1/2	1/2, 3/4	3/4, 1
Detection type	Karman vortex			
Indicator light	3-digit, 7-segment LED			
Display units (Note 3)	Instantaneous flow rate	L/min, gal(US)/min		
Accumulated flow	L, gal(US)			
Operating pressure range	0 to 1 MPa			
Proof pressure	1.5 MPa			
Accumulated flow range (Note 4)	0 to 999999 L			
Ambient temperature range	Operating: 0 to 50°C, Stored: -25 to 85°C (with no freezing and condensation)			
Output specifications (Note 5)	Switch output	NPN open collector: Maximum load current: 80 mA; Internal voltage drop: 1 V or less (with load current of 80 mA); Maximum applied voltage: 30 V; 2 outputs PNP open collector: Maximum load current: 80 mA; Internal voltage drop: 1.5 V or less (with load current of 80 mA); 2 outputs		
Accumulated pulse output	NPN or PNP open collector (same as switch output)			
Status LED's	Lights up when output is ON, OUT1: Green; OUT2: Red			
Response time	1 sec. or less			
Hysteresis	Hysteresis mode: Variable (can be set from 0), Window comparator mode (Note 6): 3-digit fixed			
Power supply voltage	12 to 24 VDC ±10%			
Environment	Enclosure	IP65		
	Operating temperature range	0 to 50°C		
	Withstand voltage	1000 VAC for 1 minute between terminals and housing		
	Insulation resistance	50 MΩ or more (500 VDC measured via megohmmeter) between terminals and housing		
Noise resistance	1000 Vp-p, Pulse width 1 μs, Rise time 1 ns			

Note 1) In the case of PF2W711, ±3% of F.S. or less (15°C to 35°C, 25°C reference). Note 2) Without lead wire.
 Note 3) For digital flow switch with unit switching function. (Fixed SI unit [L/min or L] will be set for switch type without the unit switching function.)
 Note 4) Accumulated flow rate is reset when the power supply turns OFF. (Note 5) Switch output and accumulated pulse output can be selected during initial setting.
 Note 6) Window comparator mode — Since hysteresis will reach 3 digits, keep P_1 and P_2 or n_1 and n_2 apart by 7 digits or more.
 (In case of output OUT2, n_1, 2 to be n_3, 4 and P_1, 2 to be P_3, 4.) Note 7) This product conforms to the CE marking.

How to Order

Remote Type
Sensor Unit

PF2W5 **20** - **03** - **C**

Flow rate range

04	0.5 to 4 L/min
20	2 to 16 L/min
40	5 to 40 L/min
11	10 to 100 L/min

Thread type

Nil	Rc
N	NPT
F	G

Port size

Symbol	Port size	Flow rate (L/min)				Applicable model
		4	16	40	100	
03	3/8	●	●			PF2W504, PF2W520
04	1/2		●	●		PF2W520, PF2W540
06	3/4			●	●	PF2W540, PF2W511
10	1				●	PF2W511

Lead wire (Refer to page 322.)

Nil	Lead wire with M12 connector (3 m)
N	Without lead wire

Option (Only for output specifications "1")
(Refer to page 322.)

Nil	None
C	e-con connector (1 pc.)

The cable and connector are shipped unassembled.

Output specifications

Symbol	Specification	Applicable monitor unit (monitor) model
Nil	Output for monitor unit	Series PF2W300
1	Output for monitor unit + Analog output (1 to 5 V)	Series PF2W200/300
2	Output for monitor unit + Analog output (4 to 20 mA)	Series PF2W300



Specifications

Model	PF2W504	PF2W520	PF2W540	PF2W511
Measured fluid	Water			
Detection type	Karman vortex			
Rated flow range	0.5 to 4 L/min	2 to 16 L/min	5 to 40 L/min	10 to 100 L/min
Operating pressure range	0 to 1 MPa			
Withstand pressure	1.5 MPa			
Operating fluid temperature	0 to 50°C			0 to 50°C
Accuracy ^{Note 1)}	±5% F.S.			±3% F.S.
Repeatability ^{Note 1)}	±3% F.S.			±1% F.S. (connected with PF2W33□) ±3% F.S. (connected with PF2W2□□)
Temperature characteristics	±2% F.S. (15 to 35°C, 25°C reference), ±3% F.S. (0 to 50°C, 25°C reference)			
Output specifications ^{Note 2)}	Output for display unit	Pulse output, N channel, open drain, output for monitor unit PF2W3□□. (Specifications: Maximum load current of 10 mA; Maximum applied voltage of 30 V)		
	Analog output	Voltage output 1 to 5 V Accuracy: ±5%F.S., Min. load impedance: 100 kΩ (Output impedance: 1 kΩ) Current output 4 to 20 mA Accuracy: ±5%F.S., Max. load impedance: 300 Ω or less (at 12 VDC), 600 Ω or less (at 24 VDC)		
Power supply voltage	12 to 24 VDC ±10%			
Current consumption (No load)	20 mA or less			
Environment	Enclosure	IP65		
	Operating temperature range	Operating: 0 to 50°C, Stored: -25 to 85°C (with no freezing and condensation)		
	Withstand voltage	1000 VAC for 1 minute between terminals and housing		
	Insulation resistance	50 MΩ or more (500 VDC measured via megohmmeter) between terminals and housing		
Noise resistance	1000 Vp-p, Pulse width 1 μs, Rise time 1 ns			
Weight ^{Note 3)}	410 g	470 g	650 g	1,100 g
Port size (Rc, NPT, G)	3/8	3/8, 1/2	1/2, 3/4	3/4, 1

Note 1) The system accuracy when combined with PF2W2□□/8□□.

Note 2) Output system can be selected during initial setting.

Note 3) Without lead wire. (Add 20 g for the types of analog output whether voltage or current output selected.)

Note 4) The sensor units conforms to the CE marking.

How to Order



Remote Type
Monitor Unit

PF2W3 0 0 - A - M

Flow rate range

Symbol	Flow rate range	Type for sensor unit
0	0.5 to 4 L/min	PF2W504
	2 to 16 L/min	PF2W520
	5 to 40 L/min	PF2W540
3	10 to 100 L/min	PF2W511

Output specifications

0	NPN open collector 2 outputs
1	PNP open collector 2 outputs

Mounting

A	Panel mounting
---	----------------

Unit specifications

NII	With unit switching function ^{Note1)}
M	Fixed SI unit ^{Note2)}

Note1) Under Japan's new Measurement Act, this is only for overseas sales (SI units are to be used inside Japan).

Note2) Fixed units:
Instantaneous flow rate: L/min
Accumulated flow: L

Specifications

Model		PF2W300/301		PF2W330/331
Flow rate measurement range ^{Note 1)}		0.35 to 4.5 L/min	1.7 to 17.0 L/min	3.5 to 45 L/min
Set flow rate range ^{Note 1)}		0.35 to 4.5 L/min	1.7 to 17.0 L/min	3.5 to 45 L/min
Minimum set unit ^{Note 1)}		0.05 L/min	0.1 L/min	0.5 L/min
Accumulated pulse flow rate exchange value (Pulse width: 50 ms) ^{Note 1)}		0.05 L/pulse	0.1 L/pulse	0.5 L/pulse
^{Note 2)} Display units	Instantaneous flow rate	L/min, gal(US)/min		
	Accumulated flow	L, gal(US)		
Accumulated flow range ^{Note 3)}		0 to 999999 L		
Accuracy ^{Note 4)}		±5% F.S.		±3% F.S.
Repeatability ^{Note 4)}		±3% F.S.		±1% F.S.
Temperature characteristics		±2% F.S. (0 to 50°C, 25°C reference), ±1% F.S. (15 to 35°C, 25°C reference)		
Current consumption (No load)		50 mA or less		60 mA or less
Weight		45 g		
^{Note 5)} Output specifications	Switch output	NPN open collector (PF2W300, PF2W330) Maximum load current: 80 mA Internal voltage drop: 1 V or less (with load current of 80 mA) Maximum applied voltage: 30 V 2 outputs		
		PNP open collector (PF2W301, PF2W331) Maximum load current: 80 mA Internal voltage drop: 1.5 V or less (with load current of 80 mA) 2 outputs		
	Accumulated pulse output	NPN or PNP open collector (same as switch output)		
Enclosure		IP40		
Operating temperature range		Operating: 0 to 50°C, Stored: -25 to 85°C (with no freezing and condensation)		
Withstand voltage		1000 VAC for 1 minute between terminals and housing		
Insulation resistance		50M Ω or more (500 VDC measured via megohmmeter) between terminals and housing		
Noise resistance		1000 Vp-p, Pulse width 1 μs, Rise time 1 ns		
Indicator light		3-digit, 7-segment LED		
Status LED's		Lights up when output is ON, OUT1: Green; OUT2: Red		
Power supply voltage		12 to 24 VDC ±10%		
Response time		1 sec. or less		
Hysteresis		Hysteresis mode: Variable (can be set from 0) Window comparator mode: 3-digit fixed ^{Note 6)}		

Note 1) Values vary depending on each set flow rate range.

Note 2) For digital flow switch with unit switching function, (Fixed SI unit [L/min or L] will be set for switch types without the unit switching function.)

Note 3) Accumulated flow rate is reset when the power supply turns OFF.

Note 4) The system accuracy when combined with PF2W5□□.

Note 5) Switch output and accumulated pulse output can be selected during initial setting.

Note 6) Window comparator mode — Since hysteresis (H) will reach 3 digits, keep P_1 and P_2 or n_1 and n_2 apart by 7 digits or more. (In case of output OUT2, n_1_2 to be n_3_4 and P_1_2 to be P_3_4.)

Note 7) The monitor unit conforms to the CE marking.



How to Order

4-channel Flow Monitor Remote Type Monitor Unit

Accessory/Power supply output cable (2 m)

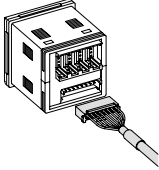

PF2W20 □ - **M** □ □

Output specifications

0	NPN 4 outputs
1	PNP 4 outputs

Unit specifications

	With unit switching function ^{Note1)}
M	Fixed SI unit ^{Note2)}

Note 1) Under the new Measurement Act, devices with unit switching functions cannot be used inside Japan.

Note2) Fixed units:
Instantaneous flow rate: L/min
Accumulated flow: L

Option 2 (Refer to page 322.)

Nil	None
4C	Sensor connector (4 pc.)

Option 1 (Refer to page 322.)

Nil	None
A	Panel mounting
B	Front protective cover + Panel mounting

Connectable remote type sensor unit is PF2W5□□-□-1 (with analog output 1 to 5 V).

Specifications

Model		PF2W200/201				
Applicable flow rate sensor		PF2W504/504T-□-1	PF2W520/520T-□-1	PF2W540/540T-□-1	PF2W511-□-1	
Flow rate measurement range ^{Note 1)}		0.35 to 4.50 L/min	1.7 to 17.0 L/min	3.5 to 45.0 L/min	7 to 110 L/min	
Set flow rate range ^{Note 1)}		0.35 to 4.50 L/min	1.7 to 17.0 L/min	3.5 to 45.0 L/min	7 to 110 L/min	
Minimum set unit ^{Note 1)}		0.05 L/min	0.1 L/min	0.5 L/min	1 L/min	
Accumulated pulse flow rate exchange value (Pulse width: 50 ms) ^{Note 1)}		0.05 L/pulse	0.1 L/pulse	0.5 L/pulse	1 L/pulse	
Display units ^{Note 1)}	Instantaneous flow rate	L/min, gal(US)/min				
	Accumulated flow	L, gal(US)				
Accumulated flow range ^{Note 1)}		0 to 999999 L, 0 to 999999 gal(US)				
Power supply voltage		24 VDC ±10% (With power supply polarity protection)				
Current consumption		55 mA or less (Note including the current consumption of the sensor)				
Power supply voltage for sensor		Same as [Power supply voltage]				
Power supply current for sensor ^{Note 2)}		Max. 110 mA (However, the total current for the 4 inputs is 440 mA maximum or less.)				
Sensor input		1 to 5 VDC (Input impedance: Approx. 800K Ω)				
Output specifications ^{Note 3)}	No. of inputs	4 inputs				
	Input protection	Excess voltage protection				
	Switch output (Real-time switch output, accumulated switch output)	NPN open collector (PF2W200)	Maximum load current: 80 mA Internal voltage drop: 1 V or less (with load current of 80 mA) Maximum applied voltage: 30 V			
		PNP open collector (PF2W201)	Maximum load current: 80 mA Internal voltage drop: 1 V or less (with load current of 80 mA)			
	Accumulated pulse output	NPN open collector or PNP open collector (same as switch output)				
	No. of outputs	4 outputs (1 output per 1 sensor input)				
Output protection	Short circuit protection					
Hysteresis		Hysteresis mode: Variable (can be set from 0), Window comparator mode: Fixed (3-digits)				
Response time ^{Note 4)}		1s or less				
Accuracy ^{Note 4)}		±5% F.S.				
Repeatability ^{Note 4)}		±3% F.S.				
Temperature characteristics		±2% F.S. (0 to 50°C, 25°C reference)				
Display method		For measured value display: 4-digits, 7-segment LED (Orange) For channel display: 1-digit, 7-segment LED (Red)				
Status LED's		Illuminates when output is ON OUT1: Red				
Environment	Enclosure	IP65 for the front face only, and IP40 for the remaining parts.				
	Operating temperature range	Operating: 0 to 50°C, Stored: -10 to 60°C (with no freezing and condensation)				
	Operating humidity range	Operating or Stored: 35 to 85%RH (with no condensation)				
	Noise resistance	500 Vp-p, Pulse width 1 μs, Rise time 1 ns				
Connection		Power supply/Output connection: 8P connector, Sensor connection: 4P connector (e-con)				
Material		Housing: PBT, Monitor: PET, Backside rubber: CR				
Weight		60 g (Except for any accessories that are shipped together)				

Note 1) Fixed SI unit [L/min or L] will be set for switch types without the unit switching function. ("M" is suffixed at the end of part number.) Accumulated flow is reset when the power supply turns OFF.

Note 2) If Vcc side on sensor input connector part is short-circuited with 0V side, the flow monitor inside will be damaged.

Note 3) Switch output and accumulated pulse output can be selected during initial setting.

Note 4) The system accuracy when combined with applicable flow sensor.

Note 5) This product conforms to the CE marking.

Series PF2W

Flow Characteristics (Pressure Loss)

PF2W704, 504

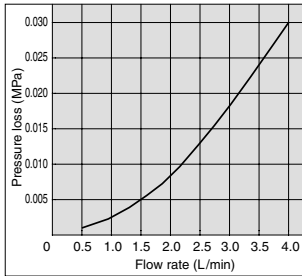

PF2W720, 520

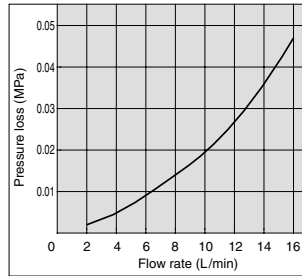

PF2W740, 540

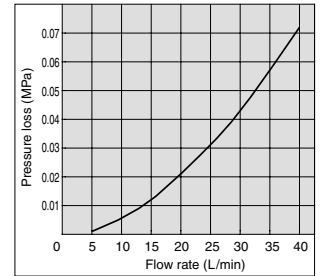

PF2W711, 511

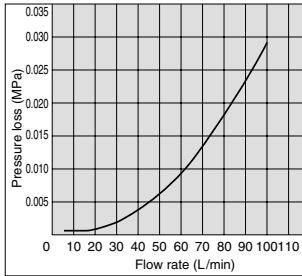

Wetted Parts Construction/Sensor Unit

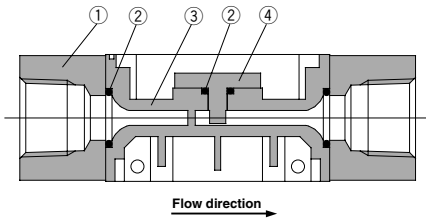

Parts list

No.	Description	Material
1	Attachment	Stainless steel
2	Seal	NBR
3	Body	PPS
4	Sensor	PPS

Dimensions: Integrated Display Type For Water

PF2W704, 720

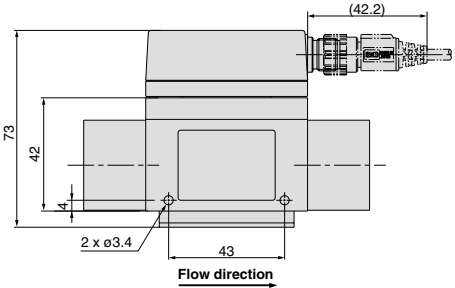
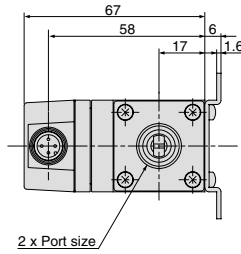
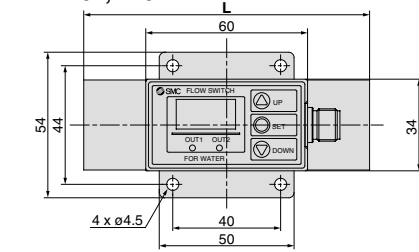

Model	L Dimension
PF2W704	100
PF2W720	106

PF2W740

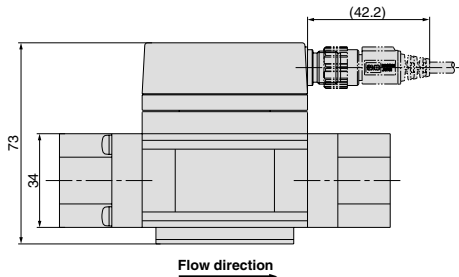
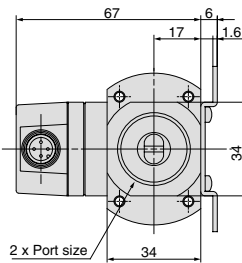
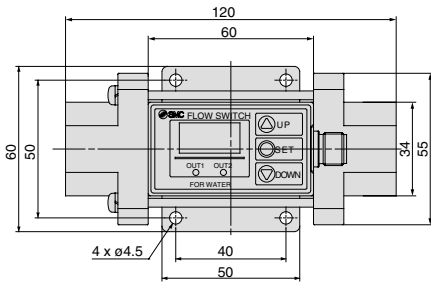

Internal Circuits and Wiring Examples

**-27
NPN (2 outputs)**

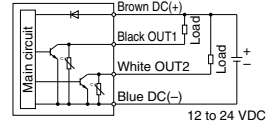

**-67
PNP (2 outputs)**

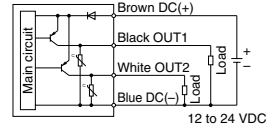

Connector pin numbers

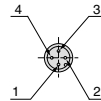

Pin no.	Pin description
1	DC(+)
2	OUT2
3	DC(-)
4	OUT1

Pressure Sensor

Pressure Control

Flow Sensor

Position Detection Switch

Reduced-wiring Fieldbus System

Static Electricity Elimination Equipment

Length Measuring/Counter

Alphabetical Index

Series PF2W

Dimensions: Integrated Display Type **For Water**

PF2W711

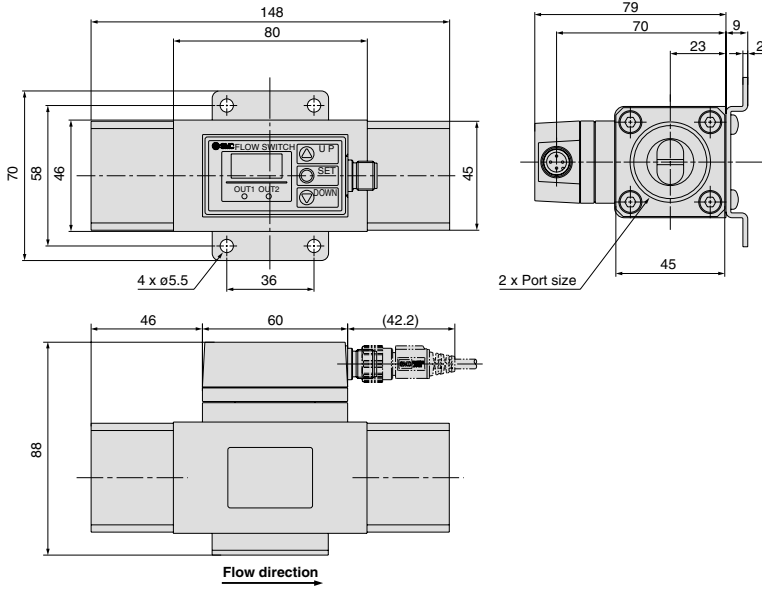

Dimensions: Remote Type Sensor Unit For Water

PF2W504, 520-□(N)-□

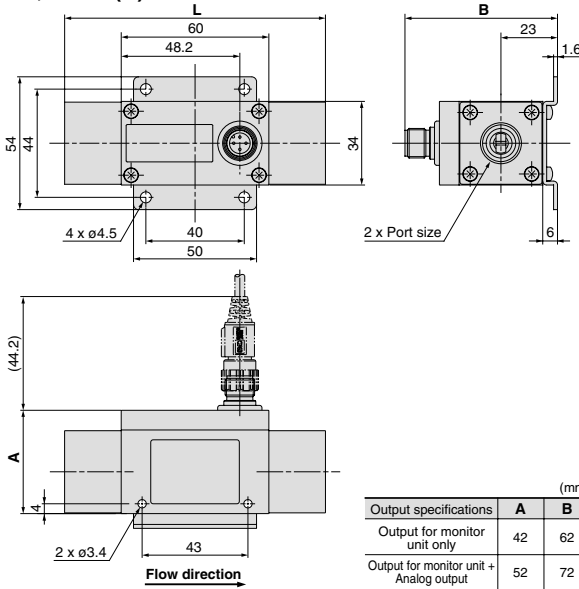

Model	L dimension
PF2W504	100
PF2W520	106

PF2W540-□(N)-□

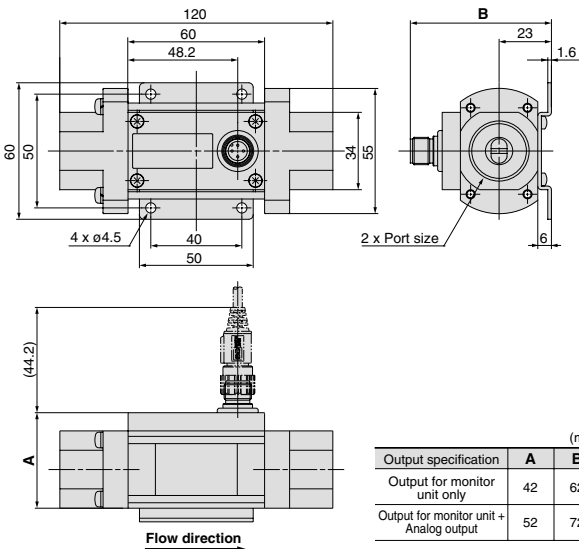

	(mm)	
Output specification	A	B
Output for monitor unit only	42	62
Output for monitor unit + Analog output	52	72

Internal Circuits and Wiring Examples

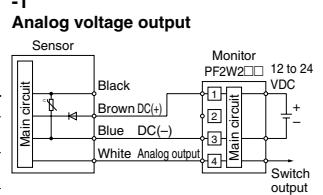
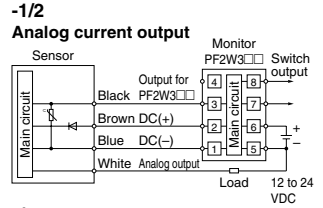
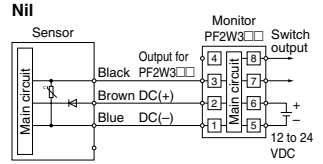

Wiring

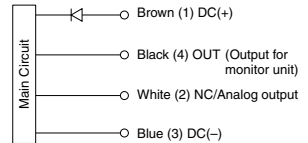

* Use this sensor by connecting it to a SMC remote type display unit, Series PF2W2□□□/3□□.

Connector pin numbers



Pin no.	Pin description
1	DC(+)
2	NC/Analog output
3	DC(-)
4	OUT

Pressure Sensor

Pressure Control

Flow Sensor

Position Detection Switch

Reduced-wiring Fieldbus System

Static Electricity Elimination Equipment

Length Measuring/Counter

Alphabetical Index

Series PF2W

Dimensions: Remote Type Sensor Unit **For Water**

PF2W511-□(N)-□

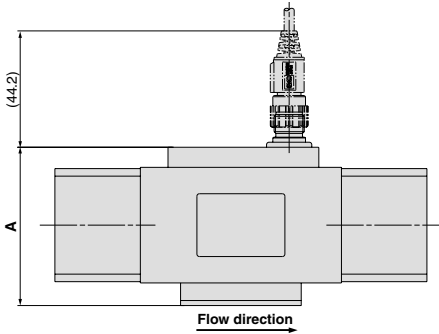
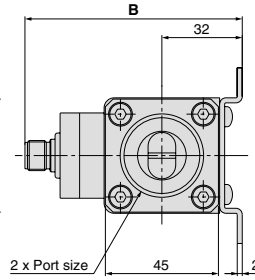
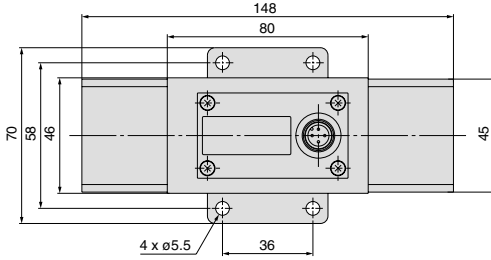

(mm)		
Output specifications	A	B
Output for monitor unit only	63	77
Output for monitor unit + Analog output	73	87

Analog output 1 to 5 VDC

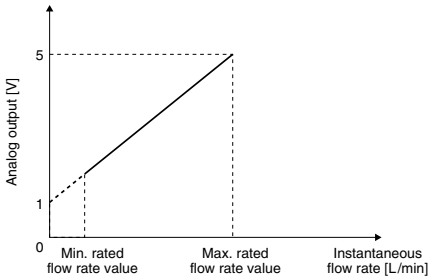

Part no.	Min. rated flow rate value [L/min]	Max. rated flow rate value [L/min]
PF2W504-□-1	0.5	4
PF2W520-□-1	2	16
PF2W540-□-1	5	40
PF2W511-□-1	10	100

4 to 20 mA DC

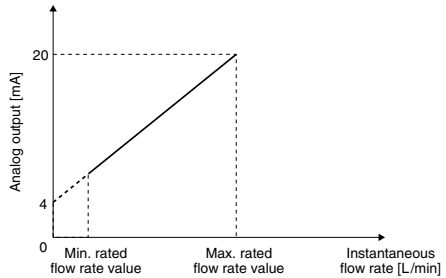

Part no.	Min. rated flow rate value [L/min]	Max. rated flow rate value [L/min]
PF2W504-□-2	0.5	4
PF2W520-□-2	2	16
PF2W540-□-2	5	40
PF2W511-□-2	10	100

Dimensions: Remote Type Monitor Unit For Water

PF2W3□□-A

Panel mount adapter type

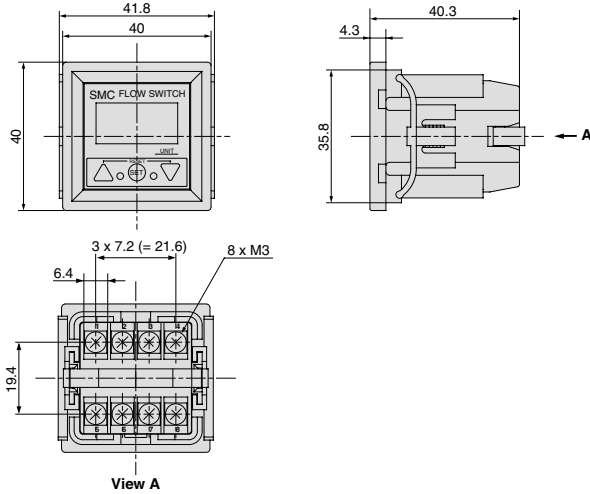

Panel fitting dimensions

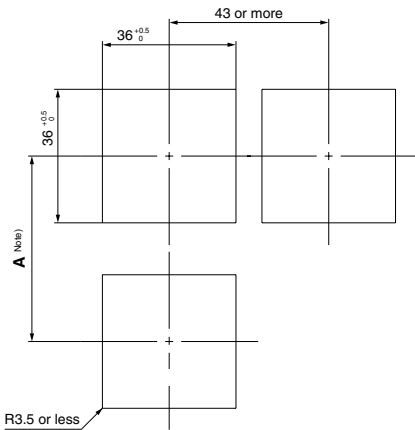

Note) Decide the length of A taking into account the size of terminal you use.
* The applicable panel thickness is 1 to 3.2 mm.
Corner: R3.5 or less

Internal Circuits and Wiring Examples

**-0
NPN (2 outputs)**

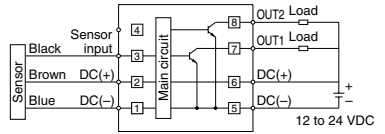

**-1
PNP (2 outputs)**

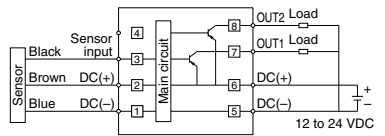

Terminal block numbers

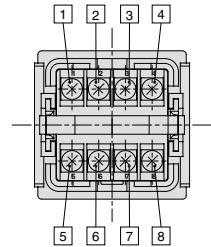

Pressure Sensor

Pressure Control

Flow Sensor

Position Detection Switch

Reduced-wiring Fieldbus System

Static Electricity Elimination Equipment

Length Measuring/Counter

Alphabetical Index

Series PF2W

Dimensions: Remote Monitor Unit **For Water** (4-channel Flow Monitor)

PF2W200, 201

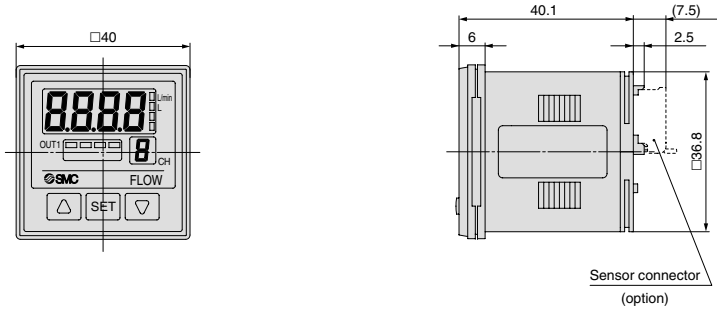

Front protective cover + Panel mount adapter

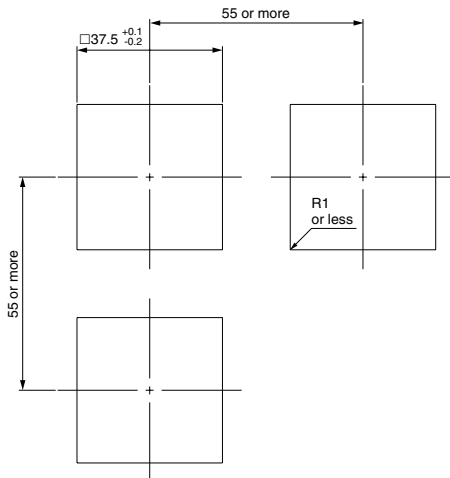
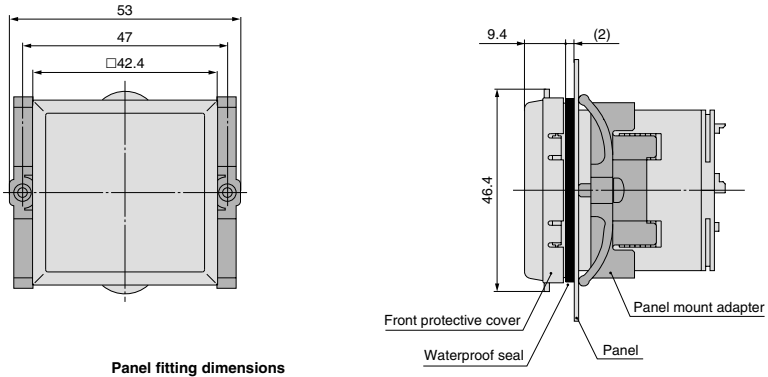

*Applicable panel thickness: 0.5 to 8 mm

Dimensions: Remote Type Monitor Unit For Water (4-channel Flow Monitor)

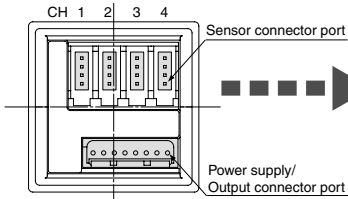

Sensor connector (4P x 4)



Connector (option)

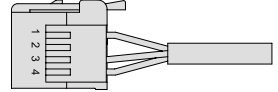

Pin no.	Terminal	Connector no.	Cable wire color
①	DC+	1	Brown
②	N.C.	2	Not used
③	DC-	3	Blue
④	IN: 1 to 5 V	4	White

Power supply/Output connector (8P)

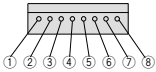

Pin no.	Terminal
①	DC (+)
②	DC (-)
③	CH1_OUT1
④	N.C.
⑤	CH2_OUT1
⑥	CH3_OUT1
⑦	CH4_OUT1
⑧	N.C.

Power supply/Output connector (accessory)

Pin No.

- 8 Yellow N.C.
- 7 Green CH4_OUT1
- 6 Red CH3_OUT1
- 5 Gray CH2_OUT1
- 4 White N.C.
- 3 Black CH1_OUT1
- 2 Blue DC(-)
- 1 Brown DC(+)

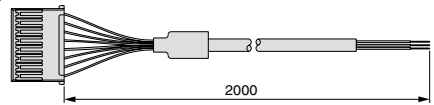

Cable Specifications

No. of cable wire	8	
Conductor	Nominal cross-sectional area	0.15 mm ²
	Dimension	Approx. 0.5 mm
Insulator	Dimension	Approx. 0.9 mm Brown, White, Blue, Black, Gray, Red, Green, Yellow
Sheath	Material	Heat-resistant polyethylene
	O.D.	4.8 mm

Internal Circuits and Wiring Examples

PF2W200
NPN (4 outputs)

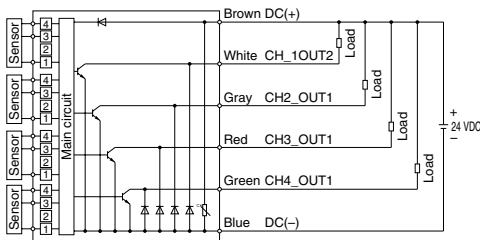

PF2W201
PNP (4 outputs)

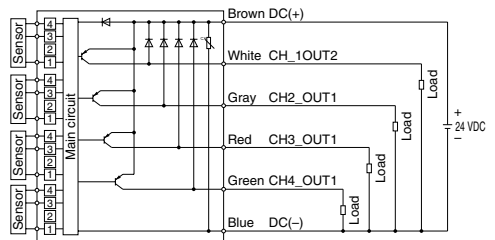

Pressure Sensor

Pressure Control

Flow Sensor

Position Detection Switch

Reduced-wiring Fieldbus System

Static Electricity Elimination Equipment

Length Measuring/Counter

Alphabetical Index

For Water

Digital Flow Switch/High Temperature Fluid Type

Series PF2W CE

How to Order



Integrated Display Type

PF2W7 20 T - 03 - 27 - -

Flow rate range

04	0.5 to 4 L/min
20	2 to 16 L/min
40	5 to 40 L/min

Temperature range

T	0 to 90°C
---	-----------

Thread type

Nil	Rc
N	NPT
F	G

Port size

Symbol	Port size	Flow rate (L/min)	Applicable model
		4 16 40	
03	3/8	● ● ●	PF2W704T/PF2W720T
04	1/2	● ● ●	PF2W720T/PF2W740T
06	3/4	● ● ●	PF2W740T

Lead wire (Refer to page 322)

Nil	Lead wire with M12 connector (3 m)
N	Without lead wire

Output specifications

27	NPN open collector 2 outputs
67	PNP open collector 2 outputs

Unit specifications

Nil	With unit switching function ^{Note1)}
M	Fixed SI unit ^{Note2)}

Note1) Under Japan's new Measurement Act, this is only for overseas sales (SI units are to be used inside Japan).

Note2) Fixed units:
Instantaneous flow rate:
L/min Accumulated flow: L

Specifications

Model	PF2W704T	PF2W720T	PF2W740T
Measured fluid	Water, Mixture of water (50%) and ethylene glycol (50%)		
Flow rate measurement range	0.35 to 4.5 L/min	1.7 to 17.0 L/min	3.5 to 45 L/min
Set flow rate range	0.35 to 4.5 L/min	1.7 to 17.0 L/min	3.5 to 45 L/min
Rated flow range	0.5 to 4 L/min	2 to 16 L/min	5 to 40 L/min
Minimum set unit	0.05 L/min	0.1 L/min	0.5 L/min
Accumulated pulse flow rate exchange value (Pulse width: 50 ms)	0.05 L/pulse	0.1 L/pulse	0.5 L/pulse
Operating fluid temperature	0 to 90°C (with no cavitation)		
Accuracy	±5% F.S.		
Repeatability	±3% F.S.		
Temperature characteristics ^{Note 1)}	±5% F.S. (0 to 90°C, 25°C reference)		
Current consumption (No load)	70 mA or less		
Weight ^{Note 2)}	710 g		
Port size (Rc, NPT, G)	3/8	3/8, 1/2	1/2, 3/4
Detection type	Karmar vortex		
Indicator light	3-digit, 7-segment LED		
Display units ^{Note 3)}	L/min, gal(US)/min		
Operating pressure range	0 to 1 MPa		
Withstand pressure	1.5 MPa		
Accumulated flow range ^{Note 4)}	0 to 999999 L		
Output specifications ^{Note 5)}	Switch output	NPN open collector Maximum load current: 80 mA; Internal voltage drop: 1 V or less (with load current of 80 mA) Maximum applied voltage: 30 V; 2 outputs	
	Accumulated pulse output	PNP open collector Maximum load current: 80 mA; Internal voltage drop: 1.5 V or less (with load current of 80 mA); 2 outputs	
Status LED's	NPN or PNP open collector (same as switch output)		
Response time	Lights up when output is turned ON OUT1: Green; OUT2: Red		
Hysteresis	1 sec. or less		
Power supply voltage	Hysteresis mode: Variable (can be set from 0); Window comparator mode ^{Note 6)} : 3-digit fixed		
Environment	Enclosure	12 to 24 VDC ±10%	
	Operating temperature range	IP65	
	Withstand voltage	Operating: 0 to 50°C, Stored: -25 to 85°C (with no freezing and condensation)	
	Insulation resistance	1000 VAC for 1 minute between terminals and housing	
	Noise resistance	50 M Ω or more (500 VDC measured via megohmmeter) between terminals and housing	

Note 1) ±5% F.S. (0 to 50°C, 25°C reference), ±3% F.S. (15 to 35°C, 25°C reference)

Note 2) Without lead wire.

Note 3) For digital flow switch with unit switching function. (Fixed SI unit [L/min or L] will be set for switch type without the unit switching function.)

Note 4) Accumulated flow rate is reset when the power supply turns OFF.

Note 5) Switch output and accumulated pulse output can be selected during initial setting.

Note 6) Window comparator mode — Since hysteresis will reach 3 digits, keep P_1 and P_2 or n_1 and n_2 apart by 7 digits or more.

(In case of output OUT2, n_1, 2 to be n_3, 4 and P_1, 2 to be P_3, 4.)

Note 7) The flow switch conforms to the CE marking.

How to Order

Remote Type
Sensor Unit

PF2W5 20 T - [] 03 [] - [] - C

Flow rate range

04	0.5 to 4 L/min
20	2 to 16 L/min
40	5 to 40 L/min

Temperature range

T	0 to 90°C
---	-----------

Thread type

Nil	Rc
N	NPT
F	G

Port size

Symbol	Port size	Flow rate (L/min)			Applicable model
		4	16	40	
03	3/8	●	●		PF2W504T/520T
04	1/2		●	●	PF2W520T/540T
06	3/4			●	PF2W540T

Lead wire (Refer to page 322.)

Nil	Lead wire with M12 connector (3 m)
N	Without lead wire

Option (Only for output specifications "1")
(Refer to page 322.)

Nil	None
C	e-con connector (1 pc.)

The cable and connector are shipped unassembled.

Output specifications

Symbol	Specification	Applicable monitor unit (monitor) model
Nil	Output for monitor unit	Series PF2W300
1	Output for monitor unit + Analog output (1 to 5 V)	Series PF2W200/300
2	Output for monitor unit + Analog output (4 to 20 mA)	Series PF2W300

Specifications

Model	PF2W504T	PF2W520T	PF2W540T
Measured fluid	Water, Mixture of water (50%) and ethylene glycol (50%)		
Detection type	Karman vortex		
Rated flow range	0.5 to 4 L/min	2 to 16 L/min	5 to 40 L/min
Operating pressure range	0 to 1 MPa		
Withstand pressure	1.5 MPa		
Operating fluid temperature	0 to 90°C (with no cavitation)		
Accuracy ^{Note 1)}	±5% F.S.		
Repeatability ^{Note 1)}	±2% F.S.		
Temperature characteristics	±2% F.S. (15 to 35°C, 25°C reference), ±3% F.S. (0 to 50°C, 25°C reference)		
Output specifications ^{Note 2)}	Output for monitor unit	Pulse output, N channel, open drain, output for monitor unit PF2W3□□. (Specifications: Maximum load current of 10 mA; Maximum applied voltage of 30 V)	
	Analog output	Voltage output 1 to 5 V Accuracy: ±5%F.S., Min. load impedance: 100 kΩ or more (Output impedance: 1 kΩ) Current output 4 to 20 mA Accuracy: ±5%F.S., Max. load impedance: 300 Ω or less (at 12 VDC), 600 Ω or less (at 24 VDC)	
Power supply voltage	12 to 24 VDC ±10%		
Current consumption (No load)	20 mA or less		
Enclosure	IP65		
Operating temperature range	Operating: 0 to 50°C, Stored: -25 to 85°C (with no freezing and condensation)		
Withstand voltage	1000 VAC for 1 minute between terminals and housing		
Insulation resistance	50 M Ω or more (500 VDC measured via megohmmeter) between terminals and housing		
Noise resistance	1000 Vp-p, Pulse width 1μs, Rise time 1ns		
Weight ^{Note 3)}	660 g		
Port size (Rc, NPT, G)	3/8	3/8, 1/2	1/2, 3/4

Note 1) The system accuracy when combined with PF2W2□□/3□□.

Note 2) Output system can be selected during initial setting.

Note 3) Without lead wire. (Add 20g for the types of analog output whether voltage or current output selected.)

Note 4) The sensor unit conforms to the CE marking.



Monitor units are the same as those of remote type digital flow switch for water (Series PF2W3□□/PF2W20□). Refer to pages 304 and 305 for details.

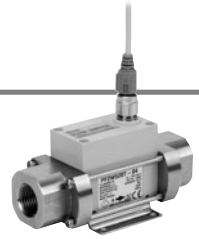

Pressure Sensor

Pressure Control

Flow Sensor

Position Detection Switch

Reduced-writing Fieldbus System

Static Electricity Elimination Equipment

Length Measuring/Counter

Alphabetical Index

Series PF2W

Flow Characteristics (Pressure Loss)

PF2W704T, 504T

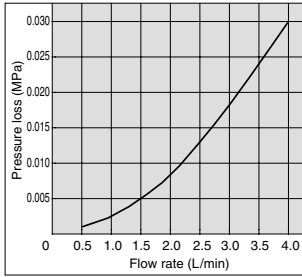

PF2W720T, 520T

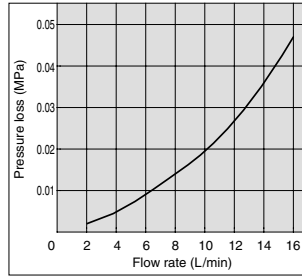

PF2W740T, 540T

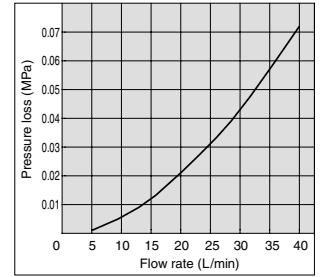

Wetted Parts Construction/Sensor Unit

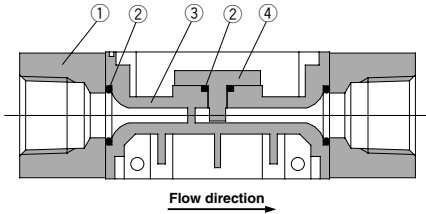

Parts list

No.	Description	Material
1	Attachment	Stainless steel
2	Seal	FKM
3	Body	PPS
4	Sensor	PPS

Dimensions: Integrated Display Type For Water

PF2W704T, 720T, 740T

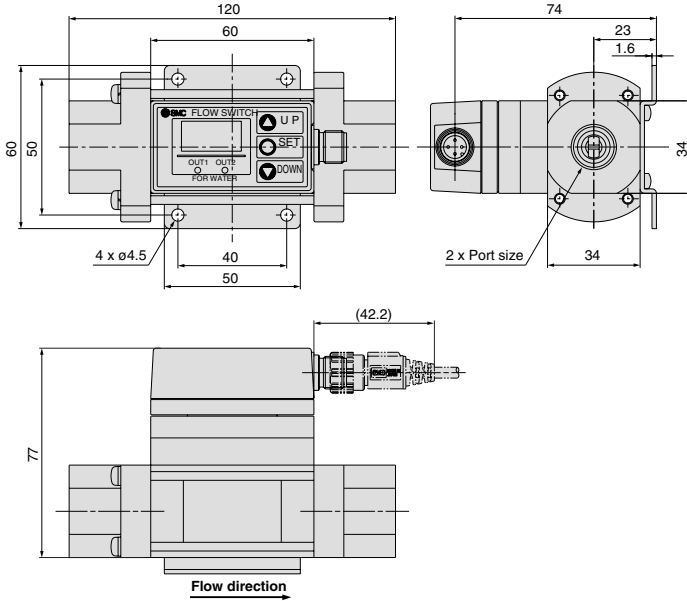

Internal Circuits and Wiring Examples

-27

NPN (2 outputs)

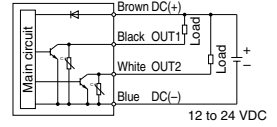

-67

PNP (2 outputs)

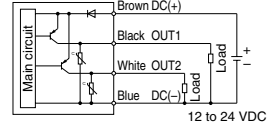

Connector pin numbers

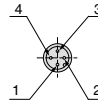

Pin no.	Pin description
1	DC(+)
2	OUT2
3	DC(-)
4	OUT1

Pressure Sensor

Pressure Control

Flow Sensor

Position Detection Switch

Reduced-wiring Fieldbus System

Static Electricity Elimination Equipment

Length Measuring/Counter

Alphabetical Index

Series PF2W

Dimensions: Remote Type Sensor Unit **For Water**

PF2W504T, 520T, 540T-□(N)

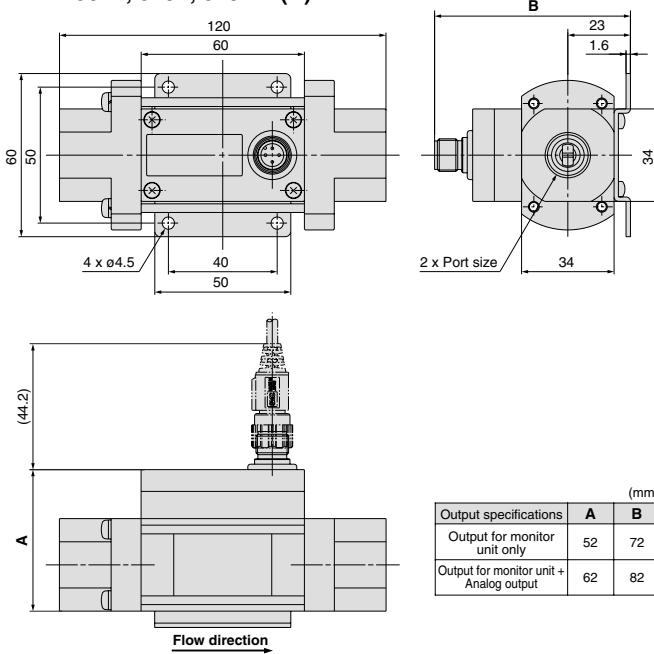

Internal Circuits and Wiring Examples

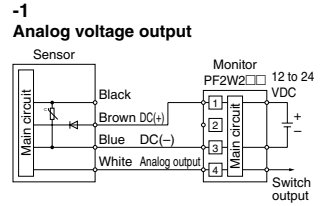
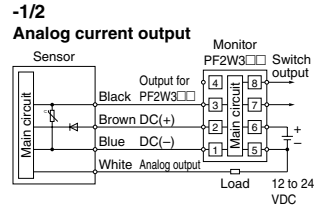
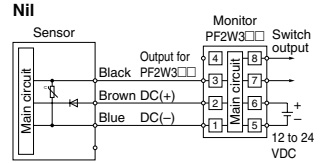

Analog output 1 to 5 VDC

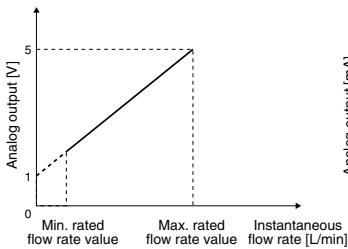

4 to 20 mA DC

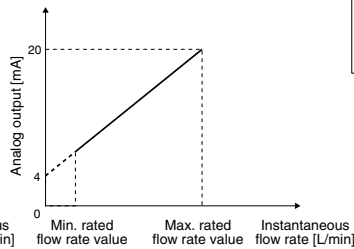

Part no.	Min. rated flow rate value [L/min]	Max. rated flow rate value [L/min]
PF2W504T-□-1	0.5	4
PF2W520T-□-1	2	16
PF2W540T-□-1	5	40

Part no.	Min. rated flow rate value [L/min]	Max. rated flow rate value [L/min]
PF2W504T-□-2	0.5	4
PF2W520T-□-2	2	16
PF2W540T-□-2	5	40

Wiring

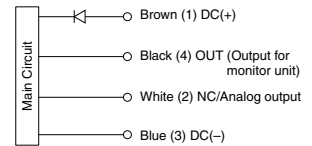

* Use this sensor by connecting it to a SMC remote type display unit, Series PF2W3□.

Connector pin numbers



Pin no.	Pin description
1	DC(+)
2	NC/Analog output
3	DC(-)
4	OUT

Description

Integrated Display Type

PF2A710, 750, 711, 721, 751
PF2W704(T), 720(T), 740(T), 711



Remote Type/Monitor Unit

PF2A300, 301, 310, 311
PF2W300, 301, 330, 331

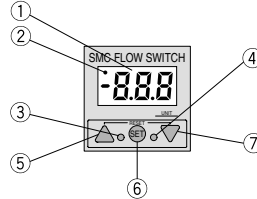

RESET button (▲ + ▼ button)

If the UP and DOWN buttons are pressed simultaneously, the RESET function will activate. In case of an emergency, please clear the display. The display of the accumulated flow will be reset to zero.

① LED display/Red	Displays the measured flow rate, each setting condition, and error code.
② Indicator (PF2A7□□, PF2A3□□ for air only)	Illuminates when the normal condition (nor) is selected.
③ Output (OUT1) display/Green	Displays the output condition of OUT1. Lights up when output is turned ON.
④ Output (OUT2) display/Red	Displays the output condition of OUT2. Lights up when output is turned ON.
⑤ UP button (▲ button)	Use to change the mode or to increase the set value.
⑥ SET button (● button)	Use this button to set the valve or the set mode.
⑦ DOWN button (▼ button)	Use to change the mode or decrease the set value.

Integrated Display Type

PF2A703H, 706H, 712H

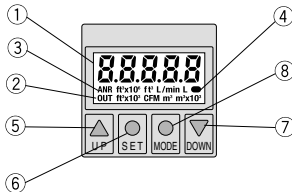

RESET button (▲ + ▼ button)

If the UP and DOWN buttons are pressed simultaneously, the RESET function will activate. In case of an emergency, please clear the display. The display of the accumulated flow will be reset to zero.

① LCD display/Orange	Displays the measured flow rate, each setting condition, and error code.
② Output (OUT1) display/Red	Displays the output condition of OUT1. Lights up when output is turned ON.
③ Unit display/Red	Displays the selected unit. Type without unit switching function is fixed SI units (L/min, or L, m ³ , m ³ × 10 ³).
④ Flow rate confirmation display/Red	The blinking intervals change depending on the flow rate value.
⑤ UP button (▲ button)	Use to change the mode or to increase the set value.
⑥ SET button (● button)	Use to select the function.
⑦ DOWN button (▼ button)	Use to change the mode or decrease the set value.
⑧ MODE button (■ button)	Use for changing the function.

4-channel Flow Monitor (Remote type/Monitor unit)

PF2A200, 201
PF2W200, 201

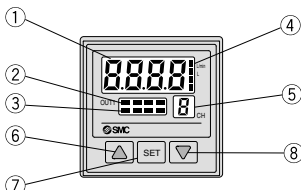

① LCD display/Orange	Displays the measured flow rate, each setting condition, and error code.
② Switch output display/Red	Displays the output condition of OUT1 (CH1 to 4). Lights up when output is turned ON.
③ Unit display of flow rate for air/Red (PF2A200, 201 for air only)	CH1 to 4 will illuminate when the normal condition (nor) is selected.
④ Unit display/Orange	Illuminates the selected unit. Use after putting the unit label other than L/min, L.
⑤ Channel display/Red	Displays the selected channel.
⑥ UP button (▲ button)	Use to change the mode or to increase the set value.
⑦ SET button	Use this button to set the value or the set mode.
⑧ DOWN button (▼ button)	Use to change the mode or decrease the set value.

Series PF2A/PF2W

Functions

Refer to the operation manual for information on setting and operating.

Flow rate measurement selection

Instantaneous flow rate and accumulated flow rate can be selected. A flow rate of up to 999999 can be accumulated. The accumulated flow rate is reset when the power supply turns OFF. (With PF2A7□H, it is possible to select a holding function.)

Unit switching

For Air

Display	Instantaneous flow rate	Accumulated flow
U_1	L/min	L
U_2	CFM x 10 ⁻² , CFM x 10 ⁻¹	ft ³ x 10 ⁻¹

CFM = ft³/min

High Flow Rate Type (For Air)

Display	Instantaneous flow rate	Accumulated flow
U_1	L/min	L, m ³ , m ³ x 10 ³
U_2	CFM	ft ³ , ft ³ x 10 ³ , ft ³ x 10 ⁶

For Water/High Temperature Fluid Type (For Water)

Display	Instantaneous flow rate	Accumulated flow
U_1	L/min	L
U_2	GPM	gal (US)

GPM = gal (US)/min

Note) Fixed SI unit (L/min, or L, m³, m³ x 10³) will be set for the type without the display unit switching function.

Flow rate conversion

Normal condition: 0°C, 101.3 kPa, dry air
Standard condition: 20°C, 101.3 kPa, 65%RH (ANR)
Switchable between these conditions.

Flow rate measuring unit confirmation

This function allows for the confirmation of the accumulated flow rate when instantaneous flow rate is selected and to confirm the instantaneous flow rate when accumulated flow rate is selected.

Keylock

This function prevents accidental operations such as changing the set value.

Accumulation clearance

This function clears the accumulated value.

Initialization of setting (only for Series PF2A7□□H)

This function restores the setting to the original state, just as it had been shipped from the factory.

Output types

Real-time switch output, accumulated switch output, or accumulated pulse output can be selected as an output type.

Real-time switch output

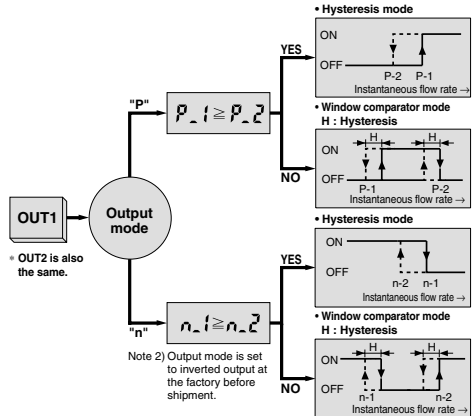

Accumulated switch output

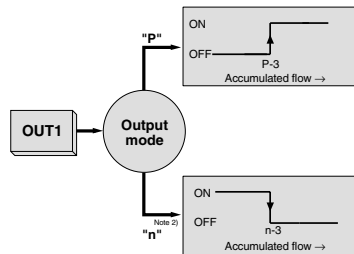

Accumulated pulse output

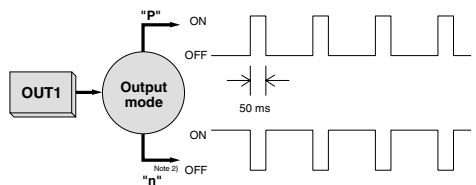

Note1) For a digital flow switch with an unit switching function. (Fixed SI unit [L/min, or L, m³ or m³ x 10³] will be set for switch types without an unit switching function.)
Refer to the specifications of the display unit for the flow rate value per pulse.

Functions

Copy function (PF2□200, 201 only)

Information to be copied is:

- ① Flow rate range
- ② Display mode
- ③ Display unit (Only available when the unit specification is nil.)
- ④ Output method
- ⑤ Output mode
- ⑥ Flow rate display unit (available with PF2A20□ only)
- ⑦ Flow rate value

Peak hold, Bottom hold display function

(PF2□200, 201 only)

The maximum or minimum value can be held in the case where the instantaneous flow rate display mode is selected during the initial setting. The hold value is reset when the power supply turns OFF or the hold is released.

Error correction

LED display	Contents	Action
Er1 <small>Note 1)</small>	A current of more than 80 mA is flowing to OUT1.	Check the load and the wiring for OUT1.
Err1 <small>Note 2)</small>	A current of more than 80 mA is flowing to OUT2.	Check the load and the wiring for OUT2.
Er2 <small>Note 1)</small>	The set data has changed for some reason.	Perform the RESET operation, and reset all the data again.
Err3 <small>Note 2)</small>	The flow rate is over the flow rate measurement range.	Use an adjustment valve, etc. to reduce the flow rate until it is within the flow rate range.
Er4 <small>Note 1)</small>		
--- <small>Note 1)</small>		
--- <small>Note 2)</small>		

Note 1) Applicable to monitor integrated type and remote type except the PF2A7□□H series.

Note 2) Applicable to the PF2A7□□H series only.

For PF2A/W200, 201

LED display	Contents	Action
Er1	Over current is flowing to the load of a switch output.	Eliminate the cause of the over current by turning off the power supply, and then turn on it again.
Er0	Internal data error.	Please contact SMC for investigation.
Er7	Internal data error.	
Er10	Internal data error.	
Er5	Internal data error.	Turn off the power supply and then turn on it again.
Er6	Internal data error.	
---	The flow rate is over the flow rate measurement range.	Use an adjustment valve, etc. to reduce the flow rate until it is within the flow rate range.

Channel select function (PF2□200, 201 only)

Every pushing the Δ button, channel selection "1→2→3→4→1..." is available. The flow rate measurement of each selected channel is shown in the monitor unit.

Channel scan function (PF2□200, 201 only)

Changes displaying the channel shown every about 2 seconds and its detected flow rate.

Pressure Sensor

Pressure Control

Flow Sensor

Position Detection Switch

Reduced-wiring Fieldbus System

Static Electricity Elimination Equipment

Length Measuring/Counter

Alphabetical Index

Series PF2A/PF2W

Option

When only optional parts are required, order with the part numbers listed below.

Lead wire with M12 connector

Part no.	Qty.	Lead wire length
ZS-37-A	1	3 m

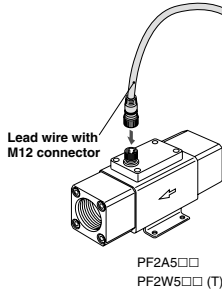
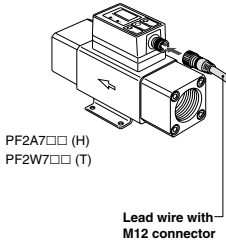

e-con connector

Part no.	Qty.
ZS-28-CA-4	1

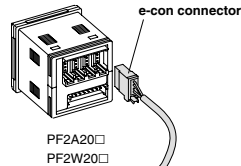

In addition to the lead wire assembly shown above, those listed below (female contact) can be connected. However, they cannot be connected with an e-con connector because the diameter of the core wire and its coverage diameter are different. For details, contact each manufacturer. Contact each manufacturer for details including RoHS compliance.

Connector size	Pin no.	Manufacturer	Applicable series
M12	4	Correns Corp.	VA-4D
		OMRON Corp.	XS2
		Yamatake Corp.	PA5-4I
		HIROSE ELECTRIC CO., LTD.	HR24
		DDK Ltd.	CM01-8DP4S

In addition to the connectors shown above, those listed below (e-con) can be connected.

Manufacturer	Model
Sumitomo 3M Limited	37104-3122-000FL
Tyco Electronics Japan G.K.	2-1473562-4
OMRON Corp.	XN2A-1430

Cable Specifications

No. of cable wire	4	
Conductor	Nominal cross-sectional area	AWG23
	Dimension	0.72 mm
Insulator	Dimension	1.14 mm Brown, White, Blue, Black
	Material	Heat-resistant and oil-resistant lead-free PVC
Sheath	O.D.	4.00 mm

Panel mounting

Pin no.	Description	Note
ZS-22-E	Panel mount adapter A, B	With mounting bracket

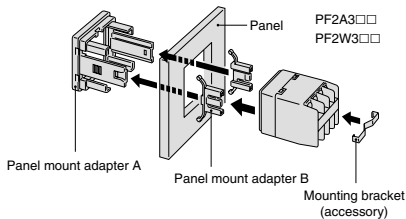

Part no.	Description	Note
ZS-26-B	Panel mount adapter	With waterproof seal, mounting screw
ZS-26-C	Front protective cover + Panel mount adapter	With waterproof seal, mounting screw

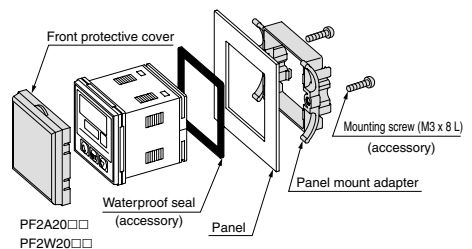

Related Product Multi Counter Series **CEU5**



How to Order

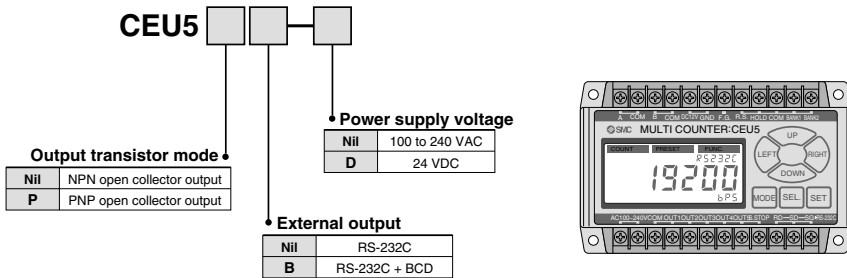

Connection Method

Connection with the Digital Flow Switch (Series PF2)

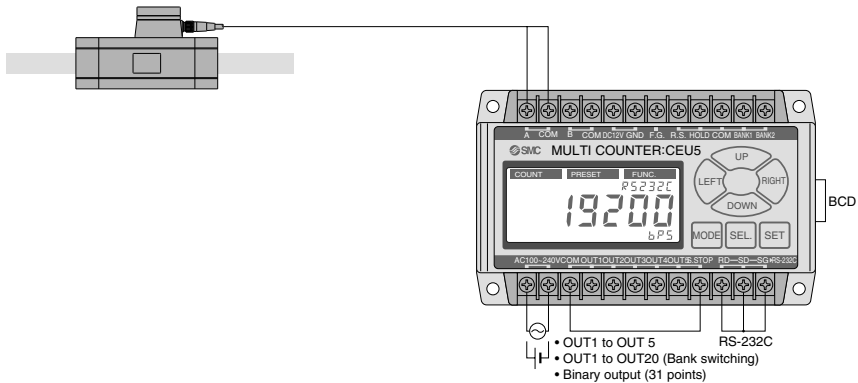

- Possible to measure accumulated pulse output of a Digital Flow Switch by an unit of 100 L (liter) and 10 ft³ (cube foot) using the pre-scaling function* of the multi counter (When inputting to the multi counter, Up or Down is selected as input method.)
- Possible to take advantage of all CEU5 functions using preset mode and function mode.

* The set value is calculated by selecting manual mode. By multiplication by 4, then, per pulse value is set.

<Connection with other manufacturers' encoders>

- Possible to switch multi counter side input method to 2-phase or Up/Down.
- Possible to connect to an encoder if the output method is Open Collector.
- When selecting UP or DOWN, phase A to COM input is counted toward addition direction, phase B to COM input is counted toward subtraction direction.

⚠ Caution

When connecting the CEU5 with an encoder from another manufacturer, please thoroughly confirm the specification beforehand. Please note that the CEU5 may not count normally depending on the output method, output frequency and connecting cable length, etc. of the encoders.

Regarding connection with scale cylinder, refer to "Stroke Reading Cylinder and Counter Series CE" in the Best Pneumatics No. 3.



Series PF2A/PF2W Specific Product Precautions 1

Be sure to read before handling. Refer to back page 1 for Safety Instructions and "Handling Precautions for SMC Products" (M-E03-3) for Flow Switch Precautions.

Design and Selection

Warning

1. Operate the switch only within the specified voltage.

Use of the switch outside of the specified voltage range can cause not only a malfunction and damage to the switch, but it can also cause electrical shock and fire.

2. Do not exceed the maximum allowable load specification.

A load exceeding the maximum load specification can cause damage to the switch.

3. Do not use a load that generates a surge voltage.

Although the circuit at the output side of the switch is surge-protected, damage may still occur if a voltage surge is applied repeatedly. When a load which generates a surge, such as from a relay or solenoid valve, is directly driven, use a switch with a built-in surge absorbing element.

4. Since the type of fluid varies depending on the product, be sure to verify the specifications.

The switches do not have an explosion proof rating. To prevent a possible fire hazard, do not use with inflammable gases or fluids.

5. Monitor the internal voltage drop of the switch.

When operating below the specified voltage, it is possible that the load may be ineffective even though the pressure switch function is normal. Therefore, the formula below should be satisfied after confirming the minimum operating voltage of the load.

$$\text{Supply voltage} - \text{Internal voltage drop of switch} > \text{Minimum operating voltage of load}$$

[For air]

6. Use the switch within the specified flow rate measurement and operating pressure.

Operating beyond the specified flow rate and operating pressure can damage the switch.

[For water]

7. Use the switch within the specified flow rate measurement and operating pressure.

Operating beyond the specified flow rate and operating pressure can damage the switch. Especially avoid the application of pressure through a water hammer, which is above the specification.

<Examples of pressure reduction measures>

- Use a device such as a water hammer relief valve to slow the valve's closing speed.
- Absorb impact pressure by using an accumulator or elastic piping material such as a rubber hose.
- Keep the piping length as short as possible.

8. Design the system, so that the fluid always fills the detection passage.

Especially for vertical mounting, introduce the fluid from the bottom to the top.

9. Operate within the flow rate measurement range.

If operated outside of the flow rate measurement range, the Karman vortex will not be generated and normal measurement will not be possible.

[Series PF2A7□□H]

10. Sudden increase in flow rate may destroy the flow sensor. Ensure to open/close the flow control valve not to exceed the maximum flow rate measurement values.

Design and Selection

Caution

1. Data from the flow switch is stored even after the power supply is turned off.

The input data is stored in EEPROM so that the data will not be lost after the flow switch is turned off. (The data can be rewritten for up to one million times, and stored for up to 20 years.)

2. Accumulated flow rate is reset when it is turned OFF.

However, only in the case of the PF2A7□□H series (for air) it is possible to select a holding function that maintains the accumulated flow rate, even though the power supply is off.

Mounting

Warning

1. Mount the switch using the proper tightening torque.

When the switch is tightened beyond the specified tightening torque, it may be damaged. On the other hand, tightening below the specified tightening torque may cause the installation screws to loosen during operation.

Thread	Tightening torque N·m
Rc 1/8	7 to 9
Rc 1/4	12 to 14
Rc 3/8	22 to 24
Rc 1/2	28 to 30

Thread	Tightening torque N·m
Rc 3/4	28 to 30
Rc 1	36 to 38
Rc 1, 1/2	48 to 50
Rc 2	48 to 50

2. Apply a wrench only to the metal part of the piping when installing the flow switch onto the system piping.

Do not apply the wrench to any part other than the piping attachment or the switch may be damaged.

3. Monitor the flow direction of the fluid.

Install and connect piping so that fluid flows in the direction of the arrow indicated on the body.

4. Remove dirt and dust from inside of the piping by means of air blow, before attaching to the switch.

5. Do not drop or bump.

Do not drop, bump, or apply excessive impacts (490 m/s²) while handling. Although the external body of the switch (switch case) may not be damaged, the switch inside could be damaged and cause a malfunction.

6. Hold the body of the switch when handling.

The tensile strength of the cord is 49N and applying a greater pulling force than this can cause a malfunction. When handling, hold the body of the switch.

7. Do not use until you can verify that equipment can operate properly.

Following mounting, repair, or retrofit, verify correct mounting by conducting suitable function and leakage tests after piping and power connections have been made.

8. Avoid the mounting orientation with the bottom of the body facing up.

The switch can be mounted in any way such as vertically or horizontally, however, avoid the mounting orientation with the bracket on the bottom of the body facing upward.



Series PF2A/PF2W

Specific Product Precautions 2

Be sure to read before handling. Refer to back page 1 for Safety Instructions and "Handling Precautions for SMC Products" (M-E03-3) for Flow Switch Precautions.

Mounting

Warning

[For air]

- Never mount a switch in a place that will be used as a step stool during piping.

Damage may occur if an excessive load is applied to the switch.

- Be sure to allow straight pipe length that is minimum 8 times the port size upstream and downstream of the switch piping.

When abruptly reducing the size of piping or when there is a restriction such as a valve on the upstream side, the pressure distribution in the piping changes and makes accurate measurement impossible. Therefore, flow restriction measures such as these should be implemented on the downstream side of the switch.

[For water]

- Never mount a switch in a place that will be used as a step stool during piping.

Damage may occur if an excessive load is applied to the switch. Especially when the switch supports the piping, do not apply a load of 15N·m or more to the metal part of the switch.

- Be sure to allow straight pipe length that is minimum 8 times the port size upstream and downstream of the switch piping.

When abruptly reducing the size of piping or when there is a restriction such as a valve on the upstream side, the flow velocity distribution in the piping changes and makes accurate measurement impossible. Therefore, flow restriction measures such as these should be implemented on the downstream side of the switch. Also, leaving the downstream side open or bringing about excessive flow volume will increase the risk of cavitation and may make accurate measurement impossible. Increasing the fluid pressure is one means of reducing cavitation. Try a procedure such as mounting a throttle on the downstream side of the switch. Check to make sure there is no malfunction before using.

Wiring

Warning

- Verify the color and the terminal number when wiring.

Incorrect wiring can cause the switch to be damaged and malfunction. Verify the color and the terminal number in the operation manual when wiring.

- Avoid repeatedly bending or stretching of the lead wire.

Repeatedly applying bending stress or stretching force to the lead wire will cause it to break.

- Confirm proper insulation of wiring.

Make sure that there is no faulty wiring insulation (contact with other circuits, ground fault, improper insulation between terminals, etc.). Damage may occur due to excess current flow into a switch.

- Do not wire in conjunction with power lines or high voltage lines.

Wire separately from power lines and high voltage lines, and avoiding wiring in the same conduit with these lines. Control circuits including switches may malfunction due to noise from these lines.

- Do not allow a load to short circuit.

Although a switch indicates excess current error if a load is short circuited, all incorrect wiring connections such as power supply polarity cannot be protected. Take precautions to avoid incorrect wiring.

Usage

Warning

- When using a switch for high temperature fluid, the switch itself also becomes hot due to the high temperature fluid. Avoid touching the switch directly as this may cause a burn.

Operating Environment

Warning

- Never use in the presence of explosive gases.

The switches do not have an explosion proof rating. Never use in the presence of an explosive gas as this may cause a serious explosion.

- Mount the switch in a locations where there is no vibration greater than 98 m/s² or impact greater than 490 m/s².

- Do not use in an area where surges are generated.

When there are units that generate a large amount of surge in the area around a pressure switch, (e.g., solenoid type lifters, high frequency induction furnaces, motors, etc.) this may cause deterioration or damage to the switch's internal circuitry. Avoid sources of surge generation and crossed lines.

- Switches are not equipped with surge protection against lightning.

The flow switches are CE compliant, however they are not equipped with surge protection against lightning. Lightning surge protection measures should be applied directly to the system components as necessary.

- Avoid using the switch in an environment where the likelihood of splashing or spraying of liquids exists.

The switches are dustproof and splashproof, however avoid using in an environment where the likelihood of heavy splashing or spraying of liquids exists. Since the monitor unit of the remote type switches featured here is not dust or splashproof, the use in an environment where liquid splashing or spraying exists must be avoided.

[For air]

- Use the switch within the specified fluid and ambient temperature range.

The fluid and ambient temperature range is 0° to 50°C. Take measures to prevent the fluid from freezing when it is below 5°C, since this may damage the switch and lead to a malfunction. The installation of an air dryer is recommended for eliminating condensation and moisture. Never use the switch in an environment where there are drastic temperature changes even when these temperatures are within the specification.

[For water]

- Use the switch within the specified fluid and ambient temperature range.

The fluid and ambient temperatures range for the switch is 0 to 50°C (and 0 to 90°C for high temperature fluid). Take measures to prevent the fluid from freezing when it is below 5°C, since this may cause damage to the switch and lead to a malfunction. Never use the switch in an environment where there are drastic temperature changes even when these temperatures fall within the specified temperature range.

Pressure Sensor

Pressure Control

Flow Sensor

Position Detection Switch

Reduced-wiring Fieldbus System

Static Electricity Elimination Equipment

Length Measuring/Counter

Alphabetical Index



Series PF2A/PF2W Specific Product Precautions 3

Be sure to read before handling. Refer to back page 1 for Safety Instructions and "Handling Precautions for SMC Products" (M-E03-3) for Flow Switch Precautions.

Maintenance

Warning

1. Perform periodical inspections to ensure proper operation of the switch.
Unexpected malfunctions may cause a possible danger.
2. Take precautions when using the switch for an interlock circuit.

When a pressure switch is used for the interlock circuit, devise a multiple interlock system to prevent trouble or malfunction, and verify the operation of the switch and interlock function on a regular basis.

3. Do not disassemble or perform any conversion work on flow switches.

Measured Fluid

Warning

1. Check regulators and flow adjustment valves before introducing the fluid.

If pressure or flow rate beyond the specified range are applied to the switch, the sensor unit may be damaged.

[For air]

2. The fluids that the switch can measure accurately are nitrogen and dry air.

Please note that accuracy cannot be guaranteed when other fluids are used.

3. Never use inflammable fluids.

The flow velocity sensor heats up to approximately 150°C.

4. Install a filter or mist separator on the upstream side when there is a possibility of condensate and foreign matter being mixed in with the fluid.

The rectifying device built into the switch will be clogged up and accurate measurement will no longer be possible.

[For water]

5. The fluid that the switch can measure accurately is water. Also, combination of equal parts water/ethylene glycol (50/50%) can be used if its temperature is high.

Please note that accuracy cannot be guaranteed when other fluids are used.

Measured Fluid

Warning

6. Never use inflammable fluids.
7. Install a filter on the inlet side when there is a possibility of condensation and foreign matter being mixed with the fluid.

If foreign matter adheres to the switch's vortex generator or vortex detector, accurate measurement will no longer be possible.

Others

Warning

1. After the power is turned on, the switch's output remains off while a message is displayed. Therefore, start the measurement after a value is displayed.

2. Perform settings after stopping control systems.
When the switch's initial setting and flow rate setting are performed, output maintains the condition prior to the settings.

3. Do not apply excessive rotational force to the monitor unit.

The integrated type display unit can rotate 360°. Rotation is controlled by the stopper; however, the stopper may be damaged if the monitor unit is turned with excessive force.

[For air]

4. Be certain to turn on the power supply when the flow rate is at zero.

Allow an interval of 10 minutes after turning on the power, as there are some changes in the display.

5. Flow rate unit

The switch measures at mass flow rates without being influenced by temperature and pressure. The switches use L/min as the flow rate indicator unit, in which the volumetric flow is substituted for mass flow at 0°C and 101.3 kPa (nor). The volumetric flow rate at 20°C, 101.3 kPa, and 65%RH (ANR) can be displayed with the high flow rate type switches for air.

Detection principle of digital flow switch for air

A heated thermistor is installed in the passage, and fluid absorbs heat from the thermistor as it is introduced to the passage. The thermistor's resistance value increases as it loses heat. Since the resistance value increase ratio has a uniform relationship to the flow velocity, the flow velocity can be detected by measuring the resistance value. To further compensate the fluid and ambient temperature, the temperature sensor is also built into the switch to allow stable measurement within the operating temperature range.

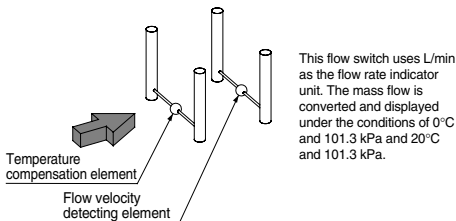

Contact SMC regarding the specifications for clean environment.

Detection principle of digital flow switch for water

When an elongated object (vortex generator) is placed in the flow, reciprocal vortices are generated on the downstream side. These vortices are stable under certain conditions, and their frequency is proportional to the flow velocity, resulting in the following formula.

$$f = k \times v$$

f: Frequency of vortex v: Flow velocity k: Proportional constant (determined by the vortex generator's dimensions and shape).

Therefore, the flow rate can be measured by detecting this frequency.

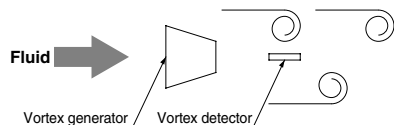



Series PF2A/PF2W Specific Product Precautions 4

Be sure to read before handling. Refer to back page 1 for Safety Instructions and "Handling Precautions for SMC Products" (M-E03-3) for Flow Switch Precautions.

Set Flow Rate Range and Rated Flow Range

⚠ Caution

Set the flow rate within the rated flow range.

The set flow rate range is the range of flow rate that can be set on the controller.

The rated flow range is the range that satisfies the sensor's specifications (accuracy, linearity etc.).

It is possible to set a value outside of the rated flow range, however, the specification is not be guaranteed.

<For Air/PF2A>

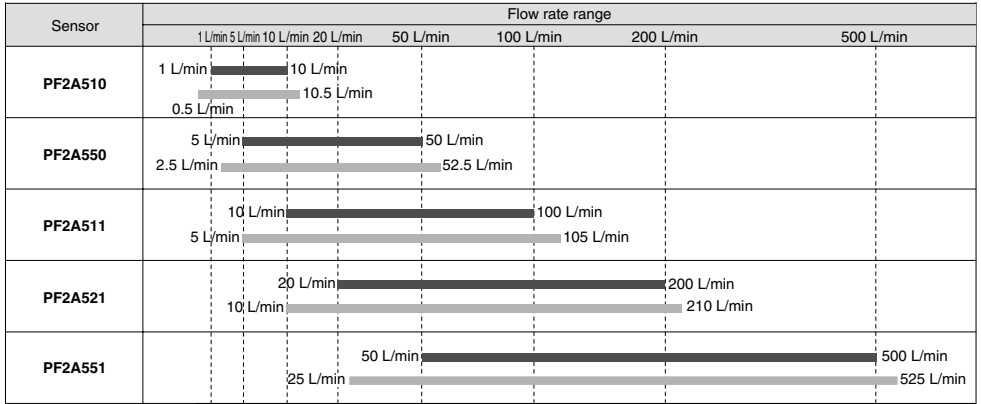

<For Water/PF2W>

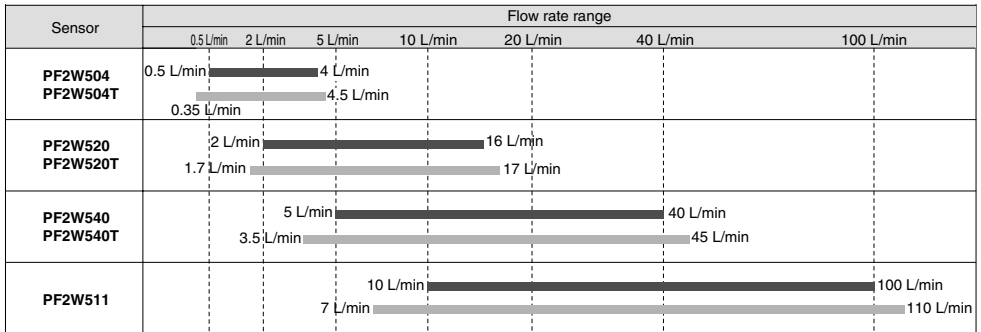

■ Rated flow range of sensor
▒ Set flow rate range of sensor

Pressure Sensor

Pressure Control

Flow Sensor

Position Detection Switch

Reduced-wiring Fieldbus System

Static Electricity Elimination Equipment

Length Measuring/Counter

Alphabetical Index



Series PF2A/PF2W Specific Product Precautions 5

Be sure to read before handling. Refer to back page 1 for Safety Instructions and "Handling Precautions for SMC Products" (M-E03-3) for Flow Switch Precautions.

■ 4-channel Flow Monitor

Handling

⚠ Warning

1. Do not drop, bump, or apply excessive impacts (980 m/s²) while handling.

Although the body of the flow monitor case may not be damaged, the inside of the flow monitor could be damaged and lead to a malfunction.

2. The tensile strength of the power supply/output connection cable is 50N and the sensor lead wire with a connector is 25N.

Applying a greater pulling force than the applicable specified tensile strength to either of these components can lead to a malfunction. When handling, hold the body of the controller.

Connection

⚠ Warning

1. Incorrect wiring can damage the switch and cause a malfunction or erroneous switch output.

Connections should be done while the power is turned off.

2. Do not attempt to insert or pull the flow rate sensor or its connector when the power is on.

Switch output may malfunction.

3. Wire separately from power lines and high voltage lines, avoiding wiring in the same conduit with these lines.

Malfunctions may occur due to noise from these other lines.

4. If a commercial switching power supply is used, make sure that the F.G. terminal is grounded.

Operating Environment

⚠ Warning

1. Our 4-channel flow monitor is CE marked, however, it is not equipped with surge protection against lightning.

Lightning surge countermeasures should be applied directly to system components as necessary.

2. Our 4-channel flow monitor does not have an explosion proof rating.

Never use pressure sensors in the presence of inflammable or explosive gases.

3. Enclosure "IP65" applies only to the front face of the panel when mounting.

Do not use in an environment where oil splashing or spraying are anticipated.

Mounting

⚠ Caution

The front face of the panel mount conforms to IP65, however there is a possibility of liquid infiltration if the panel mount adapter is not installed securely and properly. Securely fix the adapter with screws as shown below.

Front protective cover + Panel mounting

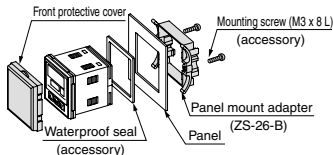

Tighten screws 1/4 to 1/2 turn after the heads are flush with the panel.

328

Wiring

⚠ Caution

1. Connecting sensor cable and connector (ZS-28-CA-□)

- Cut the sensor cable as shown below.
- Insert each lead wire into the corresponding connector number by following the chart provided below.

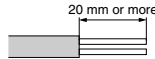

Connector no.	Cable wire color
1	Brown (DC+)
2	Not used
3	Blue (DC-)
4	White (IN: 1 to 5 V)

- Make sure that the numbers on the connector and the wire colors match. After verifying that the wires are fully inserted, temporarily hold A down by hand.

- Using pliers, press the center of A straight down.

- Note that that connector cannot be taken apart for reuse once it is crimped. Use a new sensor connector if wiring or cable insertion is done incorrectly.

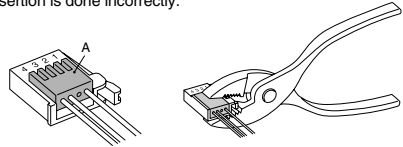

2. Inserting/Detaching of sensor connector, power supply/output connector

- Insert each connector straightforwardly until it clicks and locks onto the body.

- To remove the connector, pull it straight out while pushing the lever with your thumb.

