

# Flame Resistant (Equivalent to UL-94 Standard V-0) FR One-touch Fittings **KR-W2 Series**

RoHS

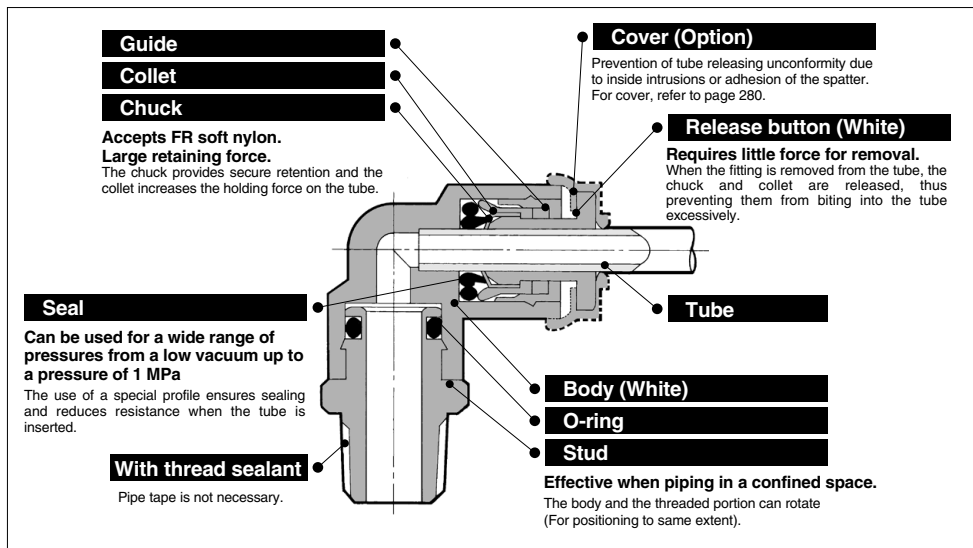

Made to Order

Symbol	Specifications
X2	Copper-free (With electroless nickel plated)

Suffix "X2" to the end of part number.  
Example) KRH06-01SW2-X2

## Applicable Tubing

Tubing material	FR double layer, FR soft nylon
Tubing O.D.	ø6, ø8, ø10, ø12

## Specifications

<b>Fluid</b>		Air/Water <sup>(1)</sup>
<b>Operating pressure range <sup>(2)</sup></b>		-100 kPa to 1 MPa
<b>Proof pressure</b>		3 MPa
<b>Ambient and fluid temperature</b>		-5 to 60°C (Water: 0 to 60°C) (No freezing)
<b>Thread</b>	<b>Mounting section</b>	JIS B 0203 (Taper thread for piping)
	<b>Nut section</b>	JIS B 0205 (Metric fine thread)
<b>Seal on the threads</b>		With sealant

Note 1) The surge pressure must be under the maximum operating pressure.

Note 2) Do not use the fittings with a leak tester or for vacuum retention because they are not guaranteed for zero leakage.

## Principal Parts Material

Body	C3604, Flame resistant PBT (UL-94 standard V-0)
Stud	C3604 (Thread portion)
Chuck	Stainless steel 304
Guide	Stainless steel 304, Flame resistant PBT (UL-94 standard V-0)
Collet	POM
Release button	Flame resistant PBT (UL-94 standard V-0)
Seal, O-ring	NBR
Cover (Option)	Flame resistant PBT, Flame resistant CR (UL-94 standard V-0)

**Model**

**Male connector**

**KRH-W2**

P.276



Use to pipe in the same direction from female thread. Most general type.

**Union elbow**

**KRL-W2**

P.277



Use to connect tubes at right angles.

**Plug-in reducer**

**KRR-W2**

P.279



Use to size down One-touch fittings.

**Straight union**

**KRH-W2**

P.276



Use to connect tubes in the same direction.

**Extended male elbow**

**KRW-W2**

P.277



Basically, it is used together with male elbow. Different point is that it is used for fittings to avoid from interfering with each other by making the piping two-level.

**Union "Y"**

**KRU-W2**

P.278



Use to branch line in the same direction.

**Male elbow**

**KRL-W2**

P.276



Use to pipe at right angles to female thread. Most general type.

**Extended plug-in elbow**

**KRW-W2**

P.279



Use to change by 90° in a tube fetching direction from One-touch fittings. Can be used with the plug-in elbow for three-dimensional pipe arrangement.

**Plug-in "Y"**

**KRU-W2**

P.278



Use to branch line in the same direction from One-touch fittings.

**45° male elbow**

**KRK-W2**

P.276



Use to pipe in 45° angle direction from female thread. Model in-between of male connector and male elbow.

**Male branch tee**

**KRT-W2**

P.277



Use to branch line from female thread in both 90° directions.

**Branch**

**KRU-W2**

P.278



Use to branch line in the same direction from female thread.

**Universal male elbow**

**KRV-W2**

P.277



Universal male elbow allows thread connection by using a socket wrench for confined spaces.

**Union tee**

**KRT-W2**

P.277



Use to connect tubes in both 90° directions.

**Bulkhead union**

**KRE-W2**

P.279



Use to connect tubes through a panel.

**Plug-in elbow**

**KRL-W2**

P.279



Use to change by 90° in a tube fetching direction from One-touch fittings.

**Male run tee**

**KRY-W2**

P.278



Use to branch line in the same direction from female thread and in 90° direction.

**Bulkhead Connector**

**KRE-W2**

P.279



Use to connect male thread and tube through a panel.

**Spatter cover**

**KR**

P.280



Prevention of tube releasing unconformity due to an inside intrusion or adhesion of the spatter.

**Spatter cover**

**KR-□C1**

P.280



Prevention of tube releasing unconformity due to an inside intrusion or adhesion of the spatter.

**Plug**

**KRP**

P.280



Use to plug unused One-touch fittings.

**KQ2**

**KQG2**

**KS  
KX**

**KM**

**KF**

**M**

**H/DL  
L/LL**

**KC**

**KK**

**KK130**

**DM**

**KDM**

**KB**

**KR**

**KA**

**KQG2**

**KG**

**KFG2**

**MS**

**KKA**

**KP**

**LQ**

**MQR**

**T**

**IDK**

# KR-W2 Series

## Dimensions

### Male Connector: KRH-W2



Applicable tubing O.D. (mm)	Connection thread R	Model	H (width across flats)	L	A <sup>①</sup>	M	Effective area (mm <sup>2</sup> )		Weight (g)
							FR double layer	FR soft nylon	
6	1/8	KRH06-01SW2	12	21.6	18.5	17	10.4	5.6	16
	1/4	KRH06-02SW2	14	22.5	17				14
	3/8	KRH06-03SW2	17	20.9	15.5				27
8	1/8	KRH08-01SW2	14	27.1	24	18.5	26.1	18.0	21
	1/4	KRH08-02SW2		26	20.5				19
	3/8	KRH08-03SW2		17	20.9				15.5
10	1/8	KRH10-01SW2	17	29.1	26	21	41.5	29.5	19
	1/4	KRH10-02SW2		33	27.5				30
	3/8	KRH10-03SW2		27.9	22.5				53
	1/2	KRH10-04SW2		22	26.1				
12	1/4	KRH12-02SW2	19	34	28.5	22	58.3	46.1	42
	3/8	KRH12-03SW2		28.9	23.5				34
	1/2	KRH12-04SW2		22	29.1				22

\* Reference dimensions after R thread installation.

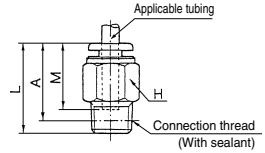

### Straight Union: KRH-W2



Applicable tubing O.D. (mm)	Model	øD (Note)	L	M	Effective area (mm <sup>2</sup> )		Weight (g)
					FR double layer	FR soft nylon	
6	KRH06-00W2	12.8	34.5	17	10.4	5.6	4
8	KRH08-00W2	15.2	38.5	18.5	26.1	18.0	6
10	KRH10-00W2	18.5	42.5	21	41.5	29.5	11
12	KRH12-00W2	20.9	44.5	22	58.3	46.1	14

Note) øD: Max. diameter

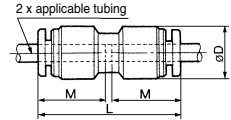

### Male Elbow: KRL-W2



Applicable tubing O.D. (mm)	Connection thread R	Model	H (width across flats)	(1)		L1	L2	A <sup>①</sup>	M	Effective area (mm <sup>2</sup> )		Weight (g)
				øD1	øD2					FR double layer	FR soft nylon	
6	1/8	KRL06-01SW2	10	12.8	10	20	22.1	25.5	17	9.0	4.2	12
	1/4	KRL06-02SW2	14				26.5	27.5				22
	3/8	KRL06-03SW2	17				27.9	29				33
8	1/8	KRL08-01SW2	12	15.2	12	23	23.6	28	18.5	21.6	14.9	13
	1/4	KRL08-02SW2	14				28	30				21
	3/8	KRL08-03SW2	17				29.4	31.5				35
10	1/8	KRL10-01SW2	17	18.5	17	26.5	26.1	32	21	21.6	14.9	25
	1/4	KRL10-02SW2					29.5	33				26
	3/8	KRL10-03SW2					30.9	34.5				35.2
	1/2	KRL10-04SW2					22	35.1				37
12	1/4	KRL12-02SW2	17	20.9	17	28.5	30.5	35.5	22	50.2	39.7	28
	3/8	KRL12-03SW2					31.9	37				38
	1/2	KRL12-04SW2					22	36.1				39.5

\* Reference dimensions after R thread installation.

Note 1) øD1: Max. diameter

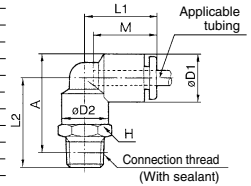

### 45° Male Elbow: KRK-W2



Applicable tubing O.D. (mm)	Connection thread R	Model	H (width across flats)	(1)		L1	L2	A <sup>①</sup>	M	Effective area (mm <sup>2</sup> )		Weight (g)
				øD1	øD2					FR double layer	FR soft nylon	
6	1/8	KRK06-01SW2	10	12.8	10	18	19.6	33	17	6.9	3.4	12
	1/4	KRK06-02SW2	14				24	35				10
	3/8	KRK06-03SW2	17				25.4	36.5				33
8	1/8	KRK08-01SW2	12	15.2	12	20.5	21.1	37	18.5	19.7	21	13
	1/4	KRK08-02SW2	14				25.5	39				35
	3/8	KRK08-03SW2	17				26.9	41				31
10	1/8	KRK10-01SW2	17	18.5	17	24	23.1	42	21	30.9	23.2	25
	1/4	KRK10-02SW2					26.5	43.5				26
	3/8	KRK10-03SW2					27.9	45				36
	1/2	KRK10-04SW2					22	32.1				47.5
12	1/4	KRK12-02SW2	17	20.9	17	25	27	45.5	22	44.5	35.1	28
	3/8	KRK12-03SW2					28.4	47.5				38
	1/2	KRK12-04SW2					22	32.6				49.5

\* Reference dimensions after R thread installation.

Note 1) øD1: Max. diameter

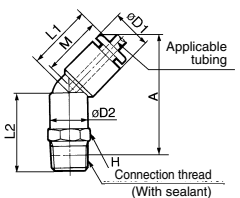

**Universal Male Elbow: KRV-W2**



Applicable tubing O.D. (mm)	Connection thread R	Model	H (width across flats)	(1)		L1	L2	L3	A*	M	Effective area (mm <sup>2</sup> )		Weight (g)					
				øD1	øD2						FR double layer	FR soft nylon						
6	1/8	KRV06-01SW2	8	12.8	13.4	24	13.6	25.6	22.5	17	5.9	2.9	15					
	1/4	KRV06-02SW2	10										15.4	23.5	18	30.5	25	26
	3/8	KRV06-03SW2	12										17.6	28.5	14.6	27.6	24.5	24
8	1/8	KRV08-01SW2	8	15.2	17.6	28.5	19.4	35.4	30	18.5	16	11.2	30					
	1/4	KRV08-02SW2	12										20.6	27.5	18	31	25.5	26
	3/8	KRV08-03SW2	14										20.6	27.5	19.4	35.4	30	40
10	1/4	KRV10-02SW2	14	18.5	20.6	31	19	35	29.5	21	27	20.3	40					
	3/8	KRV10-03SW2	17										20.9	37.4	32	49		
	1/2	KRV12-04SW2	22										24.1	40.6	33.5	63		
12	1/2	KRV12-04SW2	22	20.9	25.2	34	20.9	37.4	32	22	39	30.8	80					

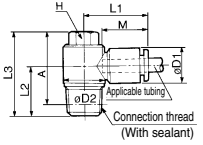

\* Reference dimensions after R thread installation. Note 1) øD1: Max. diameter

**Union Elbow: KRL-W2**



Applicable tubing O.D. (mm)	Model	øD <sup>(1)</sup>	L	Q	M	Effective area (mm <sup>2</sup> )		Weight (g)
						FR double layer	FR soft nylon	
6	KRL06-00W2	12.8	20	5.3	17	9.0	4.2	6
8	KRL08-00W2	15.2	23	6	18.5	21.6	14.9	10
10	KRL10-00W2	18.5	26.5	6.8	21	35.2	25.0	17
12	KRL12-00W2	20.9	28.5	7.5	22	50.2	39.7	21

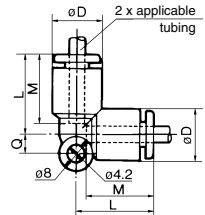

Note 1) øD: Max. diameter

**Extended Male Elbow: KRW-W2**



Applicable tubing O.D. (mm)	Connection thread R	Model	H (width across flats)	(1)		L1	L2	A*	M	Effective area (mm <sup>2</sup> )		Weight (g)		
				øD1	øD2					FR double layer	FR soft nylon			
6	1/8	KRW06-01SW2	10	12.8	10	20	39.1	42.5	17	8.6	4.0	26		
	1/4	KRW06-02SW2	14									45.5	46.5	41
	3/8	KRW06-03SW2	17									46.9	48	67
8	1/8	KRW08-01SW2	12	15.2	12	23	49	51	18.5	20.5	14.2	47		
	1/4	KRW08-02SW2	14									50.4	52.5	74
	3/8	KRW08-03SW2	17									56	59.5	66
10	1/4	KRW10-02SW2	17	18.5	17	26.5	57.4	61	21	33.5	23.8	76		
	3/8	KRW10-03SW2	22									64.1	66	145
	1/2	KRW12-04SW2	22									57	62	68
12	1/4	KRW12-02SW2	17	20.9	17	28.5	58.4	63.5	22	47.7	37.7	78		
	3/8	KRW12-03SW2	22									65.1	68.5	147
	1/2	KRW12-04SW2	22											

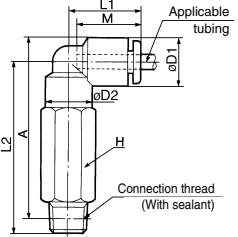

\* Reference dimensions after R thread installation. Note 1) øD1: Max. diameter

**Union Tee: KRT-W2**



Applicable tubing O.D. (mm)	Model	øD <sup>(1)</sup>	L	Q	M	Effective area (mm <sup>2</sup> )		Weight (g)
						FR double layer	FR soft nylon	
6	KRT06-00W2	12.8	20	5.3	17	10.6	6.4	10
8	KRT08-00W2	15.2	23	6	18.5	25.6	17.7	15
10	KRT10-00W2	18.5	26.5	6.8	21	40	28.4	25
12	KRT12-00W2	20.9	28.5	7.5	22	57.4	45.4	29

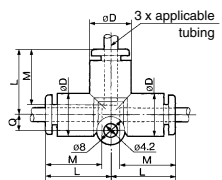

Note 1) øD: Max. diameter

**Male Branch Tee: KRT-W2**



Applicable tubing O.D. (mm)	Connection thread R	Model	H (width across flats)	(1)		L1	L2	A*	M	Effective area (mm <sup>2</sup> )		Weight (g)		
				øD1	øD2					FR double layer	FR soft nylon			
6	1/8	KRT06-01SW2	10	12.8	10	20	22.1	25.5	17	11.0	6.0	12		
	1/4	KRT06-02SW2	14									26.5	27.5	20
	3/8	KRT06-03SW2	17									27.9	29	34
8	1/8	KRT08-01SW2	12	15.2	12	23	23.6	28	18.5	26.3	18.2	14		
	1/4	KRT08-02SW2	14									28	30	22
	3/8	KRT08-03SW2	17									29.4	31.5	36
10	1/4	KRT10-02SW2	17	18.5	17	26.5	26.1	32	21	40.8	29.0	31		
	3/8	KRT10-03SW2	22									29.5	33	39
	1/2	KRT12-04SW2	22									35.1	37	66
12	1/4	KRT12-02SW2	17	20.9	17	28.5	30.5	35.5	22	57.2	45.2	41		
	3/8	KRT12-03SW2	22									31.9	37	31
	1/2	KRT12-04SW2	22									36.1	39.5	68

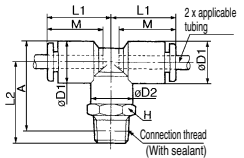

\* Reference dimensions after R thread installation. Note 1) øD1: Max. diameter

KQ2

KQB2

KS  
KX

KM

KF

M

H/DL  
L/LL

KC

KK

KK130

DM

KDM

KB

KR

KA

KQG2

KG

KFG2

MS

KKA

KP

LQ

MQR

T

IDK

# KR-W2 Series

## Male Run Tee: KRY-W2



Applicable tubing O.D. (mm)	Connection thread R	Model	H (width across flats)	(1)		L1	L2	A *	M	Effective area (mm <sup>2</sup> )		Weight (g)
				øD1	øD2					FR double layer	FR soft nylon	
6	1/8	KRY06-01SW2	10	12.8	10	20	22.1	39	17	10.6	6.4	12
	1/4	KRY06-02SW2	14				26.5	41				20
	3/8	KRY06-03SW2	17				27.9	42.5				34
8	1/8	KRY08-01SW2	12	15.2	12	23	23.6	43.5	18.5	25.6	17.7	22
	1/4	KRY08-02SW2	14				28	44.5				36
	3/8	KRY08-03SW2	17				29.4	47				31
10	1/8	KRY10-01SW2	17	18.5	17	26.5	26.1	49.5	21	40.0	28.4	29
	1/4	KRY10-02SW2					29.5	50.5				39
	3/8	KRY10-03SW2					30.9	52				31
12	1/4	KRY12-02SW2	22	20.9	17	28.5	35.1	54.5	22	57.4	45.4	41
	3/8	KRY12-03SW2	31.9				55	41				
	1/2	KRY12-04SW2	36.1				57.5	48				

\* Reference dimensions after R thread installation.

Note 1) øD: Max. diameter

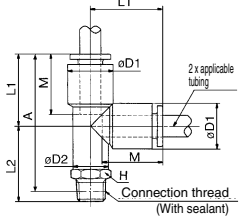

## Branch: KRU-W2



Applicable tubing O.D. (mm)	Connection thread R	Model	H (width across flats)	(1) øD	L	P	A *	M	Effective area (mm <sup>2</sup> )		Weight (g)			
									FR double layer	FR soft nylon				
6	1/8	KRU06-01SW2	13	12.8	44.6	12.8	43	17	10.4	4.2	22			
	1/4	KRU06-02SW2	14									48.5	43	35
	3/8	KRU06-03SW2	17									49.9	44.5	16
8	1/8	KRU08-01SW2	14	15.2	55	15.2	49.5	18.5	25.6	17.7	24			
	1/4	KRU08-02SW2	17									55.4	50	36
	3/8	KRU08-03SW2	19									60.5	55	30
10	1/4	KRU10-02SW2	19	18.5	60.9	18.5	55.5	21	40	28.4	40			
	3/8	KRU10-03SW2	22									64.1	57	65
	1/2	KRU10-04SW2	22									64	58.5	32
12	3/8	KRU12-03SW2	22	20.9	64.4	20.9	59	22	57.4	45.4	40			
	1/2	KRU12-04SW2	22									67.6	60.5	65

\* Reference dimensions after R thread installation.

Note 1) øD: Max. diameter

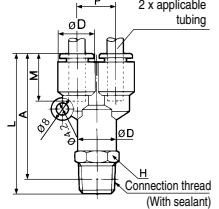

## Union "Y": KRU-W2



Applicable tubing O.D. (mm)	Model	(1) øD	L1	L2	P	Q	M	Effective area (mm <sup>2</sup> )		Weight (g)
								FR double layer	FR soft nylon	
6	KRU06-00W2	12.8	37	20	12.8	11.7	17	10.4	4.2	10
8	KRU08-00W2	15.2	42.5	24.5	15.2	13.7	18.5	25.6	17.7	12
10	KRU10-00W2	18.5	48	27.5	18.5	16.1	21	40	28.4	16
12	KRU12-00W2	20.9	51	30	20.9	18.1	22	57.4	45.4	23

Note 1) øD: Max. diameter

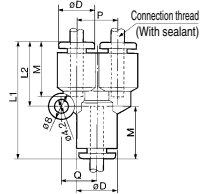

## Plug-in "Y": KRU-W2



Applicable tubing O.D. (mm)	Applicable fitting size ød	Model	(1) øD	L1	L2	P	Q	A	M	Effective area (mm <sup>2</sup> )		Weight (g)
										FR double layer	FR soft nylon	
6	6	KRU06-99W2	12.8	55.5	20	12.8	11.7	38.5	17	10.4	4.2	19
8	8	KRU08-99W2	15.2	64.5	24.5	15.2	13.7	46	18.5	25.6	17.7	22
10	10	KRU10-99W2	18.5	71.5	27.5	18.5	16.1	50.5	21	40	28.4	26
12	12	KRU12-99W2	20.9	75.5	30	20.9	18.1	53.5	22	57.4	45.4	32

Note 1) øD: Max. diameter

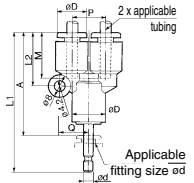

## Plug-in Elbow: KRL-W2



Applicable tubing O.D. (mm)	Applicable fitting size $\phi d$	Model	<sup>(1)</sup> $\phi D1$		$L_1$	$L_2$	A	M	Effective area (mm <sup>2</sup> )		Weight (g)
			$\phi D1$	$\phi D2$					FR double layer	FR soft nylon	
6	6	KRL06-99W2	12.8	10	20	27.5	17	17	9.0	4.2	3
8	8	KRL08-99W2	15.2	12	22.5	31.5	21	18.5	21.6	14.9	5
10	10	KRL10-99W2	18.5	14	25.5	35.5	23.5	21	35.2	25.0	9
12	12	KRL12-99W2	20.9	16	27	37.5	26	22	50.2	39.7	10

Note 1)  $\phi D1$ : Max. diameter

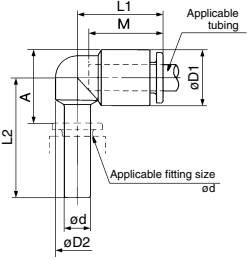

## Extended Plug-in Elbow: KRW-W2



Applicable tubing O.D. (mm)	Applicable fitting size $\phi d$	Model	<sup>(1)</sup> $\phi D1$		$L_1$	$L_2$	A	M	Effective area (mm <sup>2</sup> )		Weight (g)
			$\phi D1$	$\phi D2$					FR double layer	FR soft nylon	
6	6	KRW06-99W2	12.8	10	20	41.5	31	17	9.0	4.2	4
8	8	KRW08-99W2	15.2	10	22.5	48	37	18.5	21.6	14.9	6
10	10	KRW10-99W2	18.5	14	25.5	55	43.5	21	35.2	25.0	9
12	12	KRW12-99W2	20.9	16	27	59.5	48	22	50.2	39.7	13

Note 1)  $\phi D1$ : Max. diameter

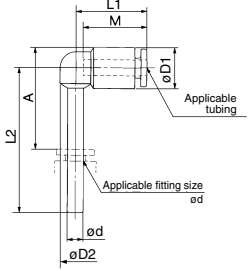

## Plug-in Reducer: KRR-W2



Applicable tubing O.D. (mm)	Applicable fitting size $\phi d$	Model	<sup>(1)</sup> $\phi D1$	L	A	M	Effective area (mm <sup>2</sup> )		Weight (g)	
							FR double layer	FR soft nylon	FR double layer	FR soft nylon
6	8	KRR06-08W2	12.8	37	18.5	17	10.4	5.6	2.5	
	10	KRR06-10W2		39.5					9.3	
8	10	KRR08-10W2	15.2	41	20	18.5	26.1	18.0	4.0	
	12	KRR08-12W2		42					4.6	
10	12	KRR10-12W2	18.5	44.5	23	21	41.5	32.8	33	

Note 1)  $\phi D1$ : Max. diameter

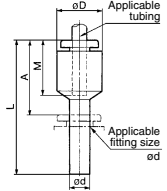

## Bulkhead Union: KRE-W2



Applicable tubing O.D. (mm)	Model	T (M)	H (width across flats)	L	Mounting hole	M	Effective area (mm <sup>2</sup> )		Weight (g)
							FR double layer	FR soft nylon	
6	KRE06-00W2	M14 x 1	17	34.5	15	17	10.4	5.6	33
8	KRE08-00W2	M16 x 1	19	38	17	18.5	26.1	18.0	52
10	KRE10-00W2	M20 x 1	24	42.5	21	21	41.5	29.5	70
12	KRE12-00W2	M22 x 1	27	44	23	22	58.3	46.1	90

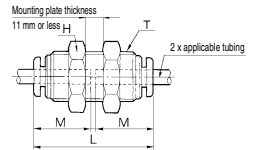

## Bulkhead Connector: KRE-W2



Applicable tubing O.D. (mm)	Connection thread Rc	Model	T (M)	H1 (width across flats)	H2 (width across flats)	$L_1$	$L_2$	Mounting hole	M	Effective area (mm <sup>2</sup> )		Weight (g)			
										FR double layer	FR soft nylon				
6	1/8	KRE06-01W2	M14 x 1	17	17	28	11	15	17	10.4	5.6	25			
	1/4	KRE06-02W2											31.5	15	40
	3/8	KRE06-03W2											33.5	17	29
8	1/4	KRE08-01W2	M16 x 1	17	27.5	7.5	17	17	18.5	26.1	18.0	28			
	3/8	KRE08-02W2											33	13	27
	1/2	KRE08-03W2											35	15	48
10	1/4	KRE10-02W2	M20 x 1	22	34.5	12.5	15	21	21	41.5	29.5	53			
	3/8	KRE10-03W2											36.5	15	67
	1/2	KRE12-03W2											37	14	92
12	1/2	KRE12-04W2	M22 x 1	24	27	14	18	23	22	58.3	46.1	92			
												59			

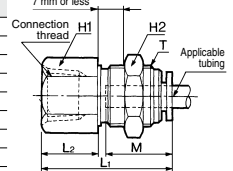

KQ2

KQB2

KS  
KX

KM

KF

M

H/DL  
L/LL

KC

KK

KK130

DM

KDM

KB

KR

KA

KQG2

KG

KFG2

MS

KKA

KP

LQ

MQR

T

IDK

# KR-W2 Series

## Plug: KRP



Applicable fitting size $\phi$ d	Model	$\phi$ D	L	A	Weight (g)
6	<b>KRP-06</b>	8	35	18	1
8	<b>KRP-08</b>	10	39	20.5	2
10	<b>KRP-10</b>	12	43	22	3.5
12	<b>KRP-12</b>	14	45.5	24	5

\* Color: Green

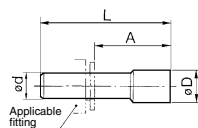

## Spatter Cover 1: KR (Applicable tube: FR soft nylon)



Applicable fitting size	Model	$\phi$ D	L	Weight (g)
6	<b>KR-06C</b>	15.5	9	0.9
8	<b>KR-08C</b>	17	9	1.0
10	<b>KR-10C</b>	20.8	10.5	1.5
12	<b>KR-12C</b>	22.8	10.5	1.6

\* When tube insert parts are in line as KQU Union "Y", use KR-□□C1.

\* Color: Gray

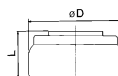

## Spatter Cover 2: KR (Applicable tube: FR soft nylon, FR double layer)



Applicable fitting size	Model	L <sub>1</sub>	L <sub>2</sub>	$\phi$ D
6	<b>KR-06C1</b>	18	13.7	12.8
8	<b>KR-08C1</b>	20	15.7	15
10	<b>KR-10C1</b>	22	17.2	18
12	<b>KR-12C1</b>	22	17.2	20

\* Color: Gray

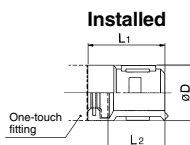

## How to install

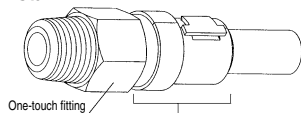

### Construction of spatter cover

