

3 Port Solenoid Valve

VV100 Series

Highly Integrated Unit Manifold



2 direct-operated 3-port valves on 1 station

Connector
(For plug-in connection)

Individually wired valve can be added.

Ø2 One-touch fitting connection is possible.

D-sub connector
Number of connectors: 15 pins, 26 pins (for plug-in connection)
• Connector entry direction

Upward

Lateral

SUP/EXH block fittings
• Fitting entry direction

Standard
(Same direction as the cylinder ports)

Side

Plug-in Connector type manifold

Non Plug-in Individual wiring manifold

VV061

VV100

V100

S070

VQD

VQD-V

VK

VT

Compact manifold with two 3-port valves on 1 station

Scale: 100%



L: Dimensions

Stations	1	2	3	4	5	6	7	8	9	10	11	12
L	34.2	44.4	54.6	64.8	75	85.2	95.4	105.6	115.8	126	136.2	146.4

Mounting

Direct mounting

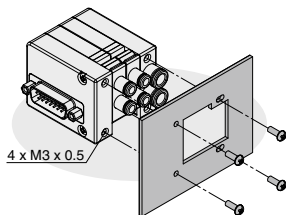

Bracket mounting

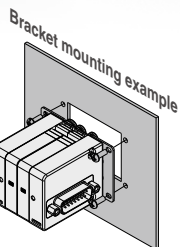
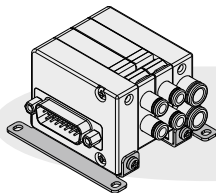

Piping Variations

- Metric size: $\phi 2$, $\phi 4$ One-touch fitting
- Inch size: $\phi 1/8$ ", $\phi 5/32$ " One-touch fitting

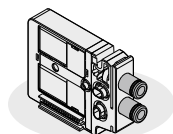

Straight fitting

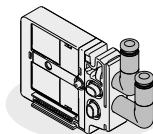

Elbow fitting
(Upward entry)

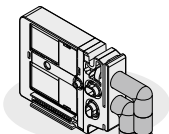

Elbow fitting
(Downward entry)

With Switch

Possible to shut the signal of each valves individually.

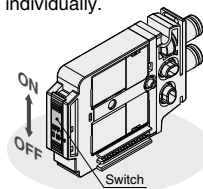

- The valve coil is not energized even if an electric signal is fed by the manifold's connector.
- Effective use as a safety measure for maintenance.

Applications

- 1 Operating a small bore size cylinder such as a pin cylinder
- 2 Air-operated valve for chemical valve



I N D E X

Common Specifications	P.1334
Construction	P.1335

Plug-in Connector Type Manifold



How to Order	P.1336, 1337
Manifold Electrical Wiring	P.1338
Connector Wiring Diagram	P.1338
Dimensions	P.1339 to 1343

Non Plug-in Individual Wiring Manifold



How to Order	P.1344, 1345
Dimensions	P.1346, 1347

Manifold Exploded View	P.1348
Manifold Options	P.1349 to 1351
Specific Product Precautions	P.1352 to 1356

VW061

VW100

V100

S070

VQD

VQD-V

VK

VT



Manifold Specifications

Model		D-sub connector		Non plug-in
		Type 10FA	Type 10FB	Type 10
Manifold type		Connector type		Individual wiring
1 (SUP), 3 (EXH)		Common SUP, EXH		
Valve stations		1 to 12 stations (Max. 7 stations if all valves have double solenoid.)	1 to 12 stations	1 to 12 stations
Applicable connector		D-sub connector 15 pins	D-sub connector 26 pins	
Internal wiring		Refer to page 1351.		
2a, 2b port piping specification		Non-polar, +COM., -COM.		
Location		Valve		
Direction		Side, Upward, Downward (Using elbow fittings for upward or downward)		
Port size		1 (SUP), 3 (EXH) port ^{Note 1)}		
2a, 2b port		C4, C6, N3, N7		
Weight W (g)		C2, C4, N1, N3		
n: Valve stations ^{Note 2)}		W = 56 + n		

Note 1) Supply to 3 port and exhaust from 1 port for V120 type (N.O.).

Note 2) The weight W is the value for the manifold only. (It is applied when the SUP/EXH block fitting is straight type.)
The weight of solenoid valve should be added by the number of stations.

Solenoid Valve Specifications

Fluid		Air	
Operating pressure range (MPa)	Positive pressure		0 to 0.7
	Vacuum pressure	N.C.	1 port: -100 kPa to 0.6/3 ports: -100 kPa to 0
Ambient and fluid temperature (°C)		-10 to 50 (No freezing)	
Maximum operating frequency (Hz)		20	
Lubrication		Not required	
Mounting orientation		Unrestricted	
Impact/Vibration resistance (m/s²) ^{Note 1)}		150/30	
Enclosure		Dustproof	
Coil rated voltage (DC)		24 V, 12 V	
Allowable voltage fluctuation (V)		±10% of rated voltage ^{Note 2)}	
Power consumption (W)	Standard		0.4
	With power saving circuit (Continuous duty type)		0, 15 ^{Note 3)} [Starting 0.4, Holding 0.15]
Surge voltage suppressor		Diode	
Indicator light		LED	

Note 1) Impact resistance: No malfunction occurred when it is tested with a drop tester in the axial direction and at the right angles to the main valve and armature in both energized and de-energized states every once for each condition. (Value in the initial state)

Vibration resistance: No malfunction occurred in one sweep test between 45 and 2000Hz. Test was performed in the axial direction and at the right angles to the main valve and armature in both energized and de-energized states for each condition. (Value in the initial state)

Note 2) For the allowable voltage fluctuation for Z and T types (with power saving circuit), observe the following range because there is voltage drop due to internal circuit.

Z type 24 VDC: -7% to +10% T type 24 VDC: -5% to +10%
12 VDC: -4% to +10% 12 VDC: -6% to +10%

Note 3) Refer to page 1353 for details.

Response Time

Response time ms (at 0.5 MPa)
7 or less

Note) Based on dynamic performance test, JIS B 8419: 2010.
(Coil temperature: 20°C, at rated voltage)

Weight

Valve model	Number of solenoids	Port size	Weight (g)
V110□-C2/C4	1 pc. (Single)	C2, C4	31
	2 pcs. (Double)	(ø2, ø4 One-touch fitting)	40

Flow Rate Characteristics

Port size		Flow rate characteristics			
1(P)	2a, 2b	1(P)→2a/2b		2a/2b→3(E)	
		C [dm ³ /(s·bar)]	b	C [dm ³ /(s·bar)]	b
C6	C2	0.03	0.22	0.05	0.31
	C4	0.03	0.19	0.05	0.29

* The effective area S (mm²) is approximately 5 times as large as the sonic conductance (S = C × 5).

Construction

Single

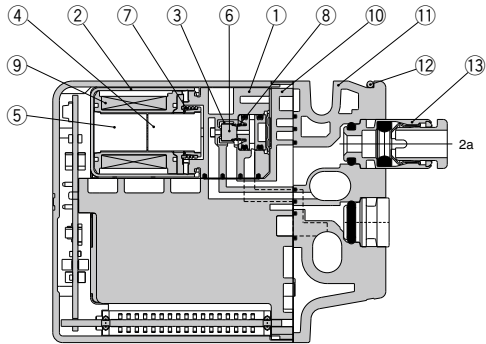
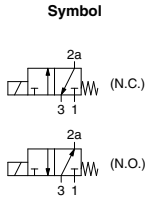

Double

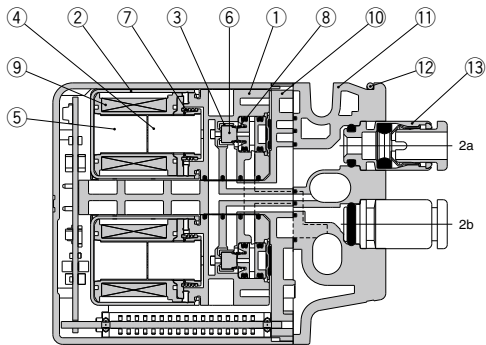
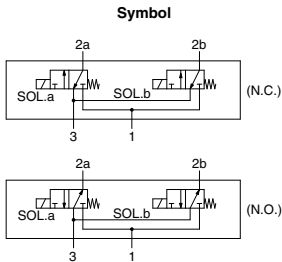

Component Parts

No.	Description	Material
1	Body	Resin
2	Cover	Stainless steel
3	Push rod	Resin
4	Armature assembly	Stainless steel/Resin
5	Core	Stainless steel
6	Poppet	FKM
7	Return spring	Stainless steel
8	Poppet spring	Stainless steel
9	Coil assembly	—
10	Pilot adapter	Resin
11	Port block	Resin
12	Clip	Stainless steel

Replacement Parts

One-touch Fitting (Metric Size)

No.	Port	Port size	Part no.
13	2a, 2b	ø2 One-touch fitting (Straight)	KJH02-C1
		ø4 One-touch fitting (Straight)	KJH04-C1
		ø2 One-touch fitting (Elbow)	KJL02-C1
		ø4 One-touch fitting (Elbow)	KJL04-C1-N
		ø2 One-touch fitting (Long elbow)	KJW02-C1
		ø4 One-touch fitting (Long elbow)	KJW04-C1-N
13	1(P), 3(E)	ø4 One-touch fitting (Straight)	VVQ1000-50A-C4
		ø6 One-touch fitting (Straight)	VVQ1000-50A-C6
		ø4 One-touch fitting (Elbow)	SZ3000-73-1A-L4
		ø6 One-touch fitting (Elbow)	SZ3000-73-1A-L6
		ø4 One-touch fitting (Long elbow)	SZ3000-73-2A-L4
		ø6 One-touch fitting (Long elbow)	SZ3000-73-2A-L6

One-touch Fitting (Inch Size)

No.	Port	Port size	Part no.
13	2a, 2b	ø1/8" One-touch fitting (Straight)	KJH01-C1
		ø5/32" One-touch fitting (Straight)	KJH03-C1
13	1(P), 3(E)	ø5/32" One-touch fitting (Straight)	VVQ1000-50A-N3
		ø1/4" One-touch fitting (Straight)	VVQ1000-50A-N7

VV061

VV100

V100

S070

VQD

VQD-V

VK

VT

3 Port Solenoid Valve



VV100 Series/D-sub Connector Plug-in Connector Type Manifold



How to Order Manifold

VV100-10F A D 2 - 05 U 1 - C6

D-sub connector type

Symbol	Number of poles
A	15
B	26

Connector block mounting position: D side

Connector entry direction

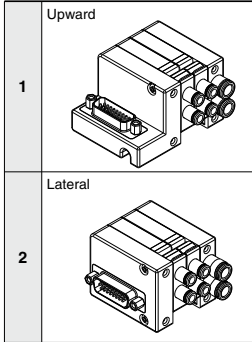

Valve stations

A: D-sub connector 15 pins

Symbol	Stations	Note
01	1 station	Up to 14 solenoids possible.
⋮	⋮	
12	12 stations	

B: D-sub connector 26 pins

Symbol	Stations	Note
01	1 station	Up to 24 solenoids possible.
⋮	⋮	
12	12 stations	

SUP/EXH block mounting position: U side

Mounting option

Symbol	Mounting
Nil	Manifold direct mounting type
Note) N	Manifold direct mounting type
F1	With bracket (Standard)
F2	With bracket (Port downward)

Note) If the mounting option "N" (Mounting nut: Inch size) is selected, the bracket cannot be mounted.

SUP/EXH block port size

One-touch fitting (Metric size)

C4	ø4 One-touch fitting (Straight)
C6	ø6 One-touch fitting (Straight)
L4	ø4 elbow fitting (Upward entry)
L6	ø6 elbow fitting (Upward entry)
B4	ø4 elbow fitting (Downward entry)
B6	ø6 elbow fitting (Downward entry)

One-touch fitting (Inch size)

N3	ø5/32" One-touch fitting (Straight)
N7	ø1/4" One-touch fitting (Straight)

How to Order Valve Manifold Assembly

Ordering example (VV100-10FA)

Double solenoid, individual wiring/lead wire length 300 mm (24 VDC)

V110-D5MZ-C4 (1 set)

Double solenoid (24 VDC)

V110-D5CZJ-C4 (1 set)

Double solenoid (24 VDC)

V110-D5CU-C4 (3 sets)

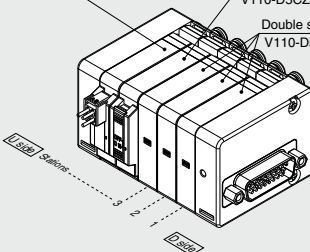

VV100-10FAD2-05U1-C6 1 set (Manifold part no.)

- * V110-D5CU-C4 3 sets (Double solenoid part no.)
- * V110-D5CZJ-C4 1 set (Double solenoid, with switch part no.)
- * V110-D5MZ-C4 1 set (Double solenoid, individual wiring/lead wire length 300 mm part no.)

The asterisk denotes the symbol for assembly. Prefix to the part no. of the solenoid valve, etc.

- The valve arrangement is numbered as the 1st station from D side.
- Indicate the valves to be attached below the manifold part number, in order starting from station 1 as shown in the drawing.

SUP/EXH block fitting entry direction

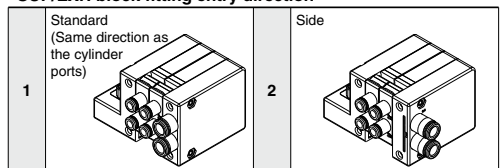

* If the mounted valve is N.O., apply pressure to the 3(E) port and exhaust air from the 1(P) port.



How to Order Valve for Connector Type

Standard

V1 1 0 T - D 5 □ CU - C4 - □

With switch

V1 1 0 - D 5 □ CZ J - C4 - □

Individual wiring
[For plug-in mixed mounting] ^{Note)}

V1 1 0 T - D 5 □ MZ - C4

Note) See page 1345 for the dedicated non plug-in individual wiring.

Type of actuation

1	Normally closed (N.C.)
2	Normally open (N.O.)

* Normally closed and normally open type cannot be mounted on the same manifold. Refer to "Manifold Specifications" on page 1334 for the pressure port.

Coil specification

Nii	Standard
T	With power saving circuit (Continuous duty type)

* Be certain to select "with power saving circuit" when the solenoid valve will be energized continuously for long periods of time.

Number of solenoids

Symbol	Specifications
S	1 pc. (Single solenoid)
D	2 pcs. (Double solenoid)

Rated voltage

5	24 VDC
6	12 VDC

Common specification

Nii	+COM.
N	-COM.

* For the non-polar type, there is no need to select a symbol.

Connector entry

C: Dedicated for centralized wiring

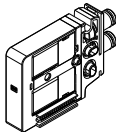

M: Individual wiring. With lead wire
Length 300 mm

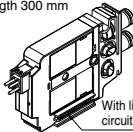

With linkage printed circuit board

MN: Individual wiring. Without lead wire
(With connector, socket)

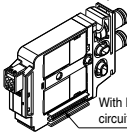

With linkage printed circuit board

MO: Individual wiring. Without connector

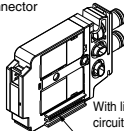

With linkage printed circuit board

* Connector entries with the symbol "M□" cannot use the switch signal from the D-sub connector on the manifold.
For details, refer to Manifold Electrical Wiring on page 1338.

* When ordering a connector assembly separately, see pages 1355 and 1356.

Light/Surge voltage suppressor

U	With light/surge voltage suppressor (Non-polar type)
Z	With light/surge voltage suppressor (Polar type)

* When the types with power saving circuit, with switches, and individual wiring are used, the non-polar type cannot be selected.

With switch

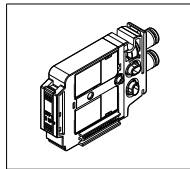

Single solenoid wiring specification

Nii	Single wiring
D	Double wiring

* Nil for the double solenoid. Select this when the unused numbers to wiring are set. See page 1338 for details.

2a/2b fitting port size

Straight fitting
(Metric size)

C2: ø2 One-touch fitting
C4: ø4 One-touch fitting

(Inch size)

N1: ø1/8" One-touch fitting
N3: ø5/32" One-touch fitting

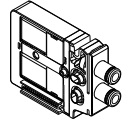

Elbow fitting (Upward entry)
(Metric size)

L2: ø2 One-touch fitting
L4: ø4 One-touch fitting

(Inch size)

LN1: ø1/8" One-touch fitting
LN3: ø5/32" One-touch fitting

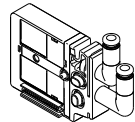

Elbow fitting (Downward entry)
(Metric size)

B2: ø2 One-touch fitting
B4: ø4 One-touch fitting

(Inch size)

BN1: ø1/8" One-touch fitting
BN3: ø5/32" One-touch fitting

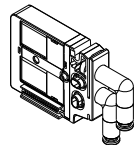

VV061

VV100

V100

S070

VQD

VQD-V

VK

VT

VV100 Series

Manifold Electrical Wiring (Image)

When a valve is added, the signals of the connector are assigned to the valve. This makes it completely unnecessary to disassemble the connector unit.

* The connector arrangement shown below differs from the actual arrangement. Refer to the Connector Wiring Diagram below.

Single Solenoid and Double Solenoid

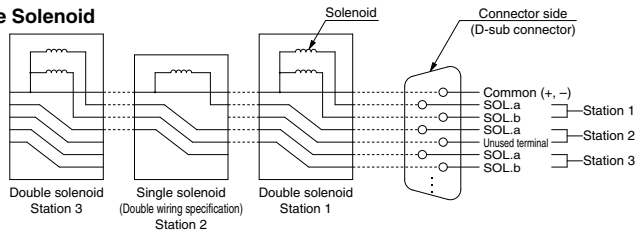

Single Solenoid with Double Wiring Specification

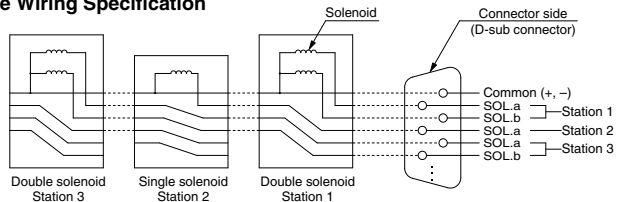

Individually Wired Valve

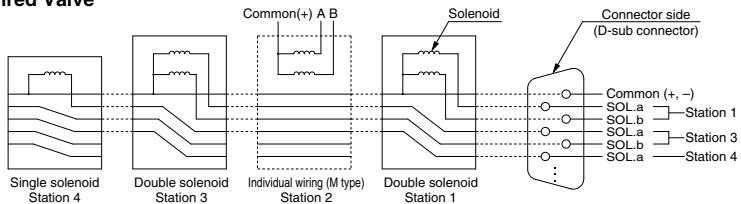

Connector Wiring Diagram

Type FA: D-sub connector (15 pins)

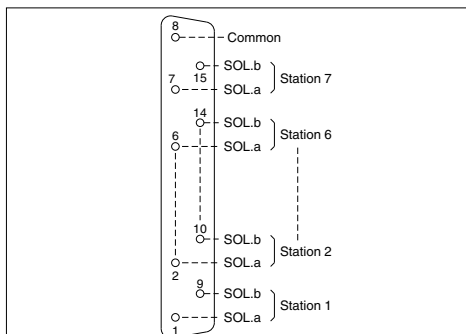

Note) This circuit is for the specification with up to 7 stations of double solenoid valves. This should be wired in order 1→9→2→10 without skipping or leaving any connectors remaining.

Type FB: D-sub connector (26 pins)

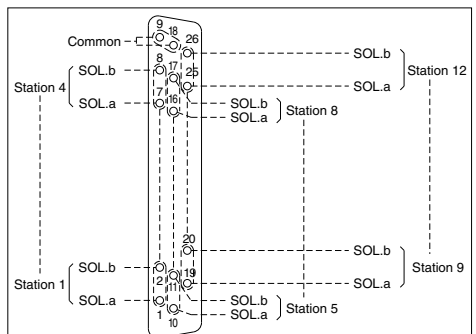

Note) This circuit is for the specification with up to 12 stations of double solenoid valves. This should be wired in order 1→2→3→4 with the exception of 9, 18 (Common) without skipping or leaving any connectors remaining.

Caution

When the non-polar U type valves are used, either +COM or -COM wiring of the manifold is possible. However when Z type valves are used, select the common specifications, +COM or -COM.

3 Port Solenoid Valve/D-sub Connector

Plug-in Connector Type Manifold **VV100 Series**

Dimensions

VV100-10F $\frac{1}{4}$ D1-**Stations** U $\frac{1}{2}$ -□□

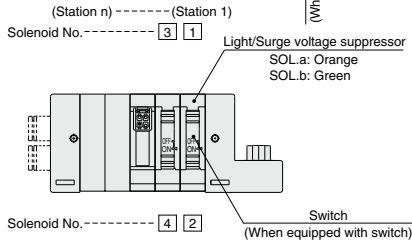
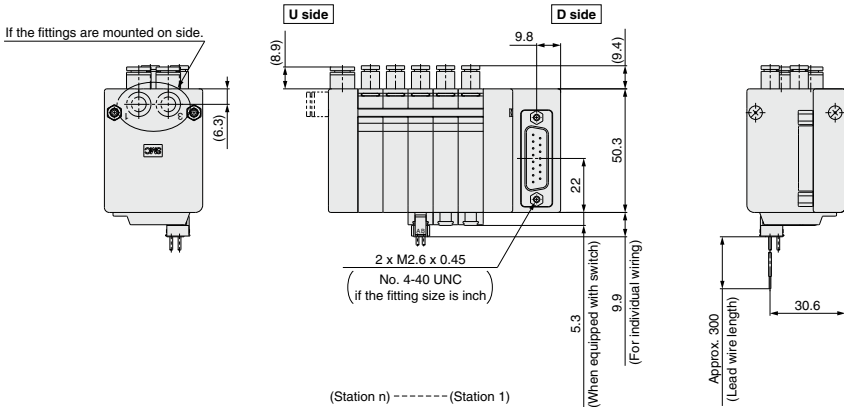
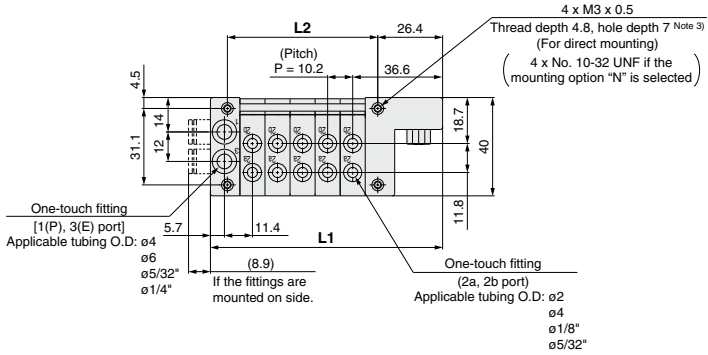

- Note 1) 10FA and 10FB types have the same L1 and L2 dimensions, and the only difference is the number of poles of the connector. See page 1338 for the pin arrangement.
- Note 2) For manifold dimensions including elbow fitting, see page 1343.
- Note 3) As the distance between the block end to the thread is 2.5 mm, the screw depth should be 5 to 7 mm.

L: Dimensions

L	n: Stations											
	1	2	3	4	5	6	7	8	9	10	11	12
L1	53.7	63.9	74.1	84.3	94.5	104.7	114.9	125.1	135.3	145.5	155.7	165.9
L2	20.4	30.6	40.8	51	61.2	71.4	81.6	91.8	102	112.2	122.4	132.6

VV061

VV100

V100

S070

VQD

VQD-V

VK

VT

VV100 Series

Dimensions

VV100-10F¹D1 - Stations U₂ - □ □ F₂

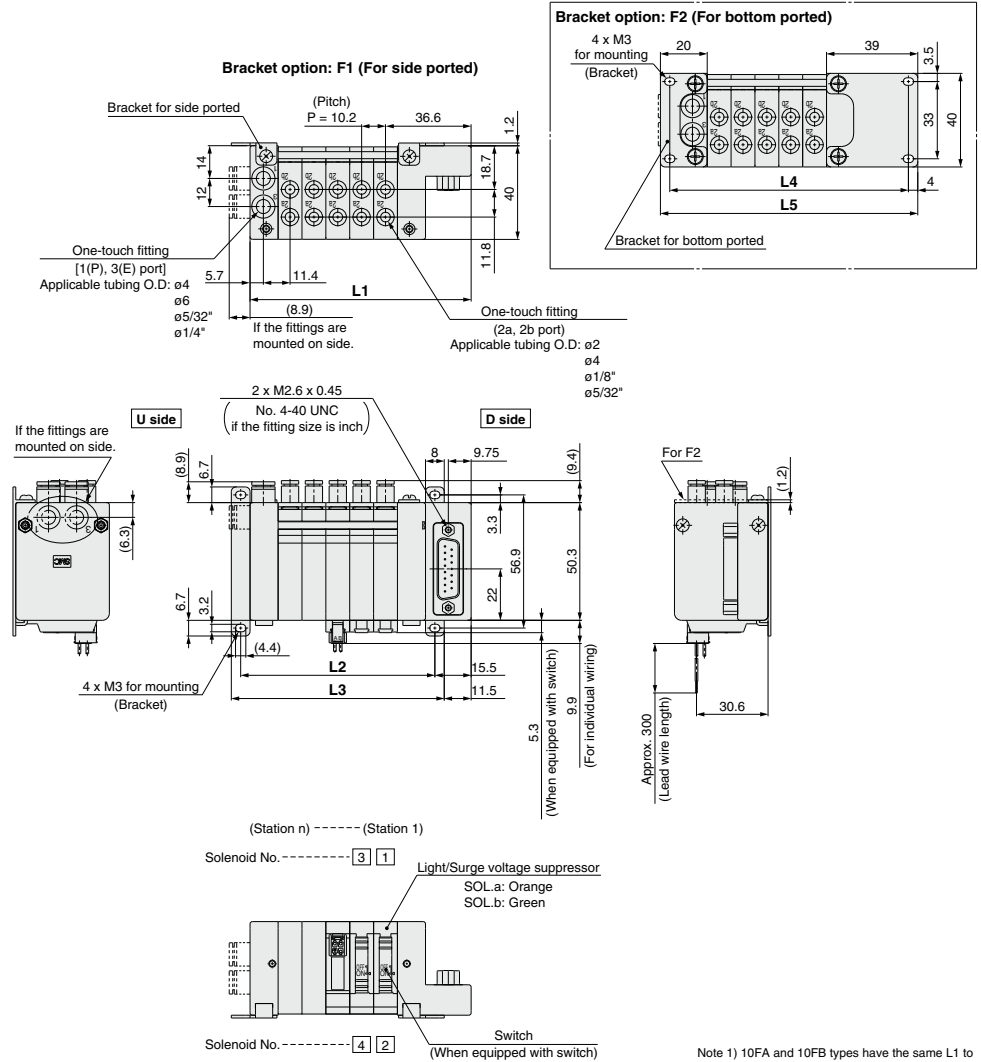

Note 1) 10FA and 10FB types have the same L1 to L5 dimensions, and the only difference is the number of poles of the connector. See page 1338 for the pin arrangement.

Note 2) For manifold dimensions including elbow fitting, see page 1343.

L: Dimensions

		n: Stations											
L	n	1	2	3	4	5	6	7	8	9	10	11	12
L1		53.7	63.9	74.1	84.3	94.5	104.7	114.9	125.1	135.3	145.5	155.7	165.9
L2		42.2	52.4	62.6	72.8	83	93.2	103.4	113.6	123.8	134	144.2	154.4
L3		50.2	60.4	70.6	80.8	91	101.2	111.4	121.6	131.8	142	152.2	162.4
L4		61.2	71.4	81.6	91.8	102	112.2	122.4	132.6	142.8	153	163.2	173.4
L5		68.6	78.8	89	99.2	109.4	119.6	129.8	140	150.2	160.4	170.6	180.8

1340

3 Port Solenoid Valve/D-sub Connector

Plug-in Connector Type Manifold **VV100 Series**

VV100-10F/D2-Stations U₂-□□

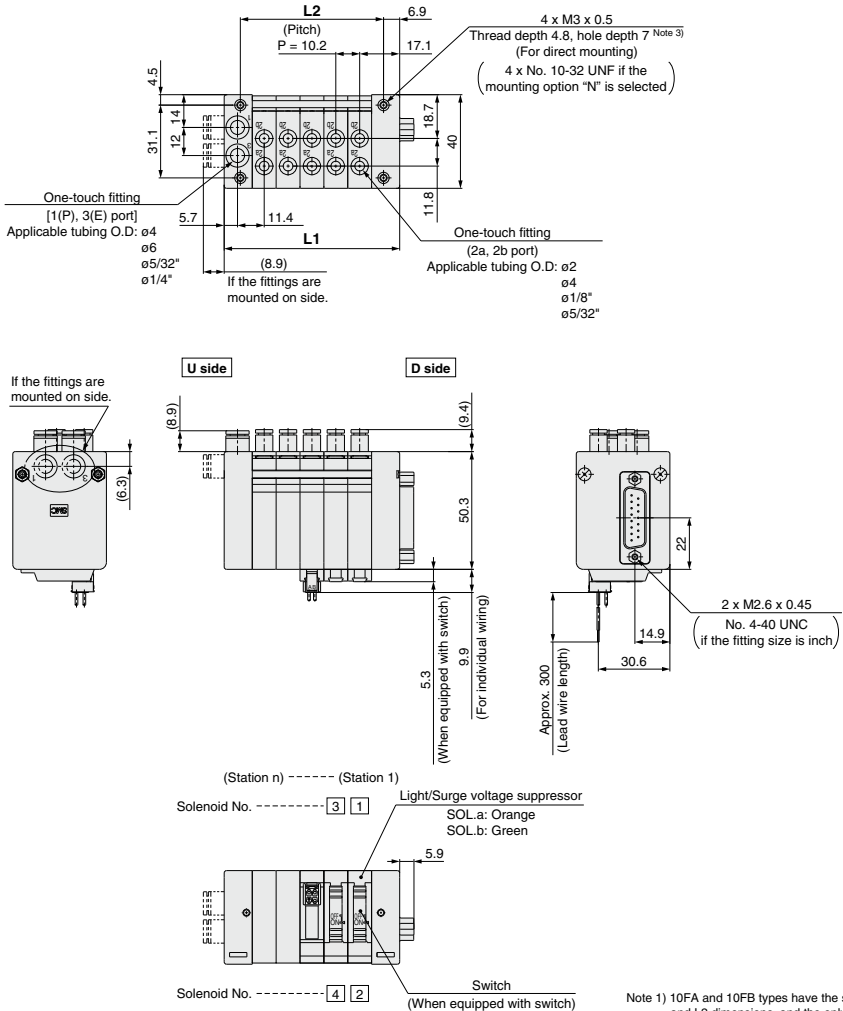

L: Dimensions

L	n	n: Stations											
		1	2	3	4	5	6	7	8	9	10	11	12
L1		34.2	44.4	54.6	64.8	75	85.2	95.4	105.6	115.8	126	136.2	146.4
L2		20.4	30.6	40.8	51	61.2	71.4	81.6	91.8	102	112.2	122.4	132.6

Note 1) 10FA and 10FB types have the same L1 and L2 dimensions, and the only difference is the number of poles of the connector. See page 1338 for the pin arrangement.

Note 2) For manifold dimensions including elbow fitting, see page 1343.

Note 3) As the distance between the block end to the thread is 2.5 mm, the screw depth should be 5 to 7 mm.

VV061

VV100

V100

S070

VQD

VQD-V

VK

VT

VV100 Series

Dimensions

VV100-10F¹D2-Stations U₂-□□ F₂

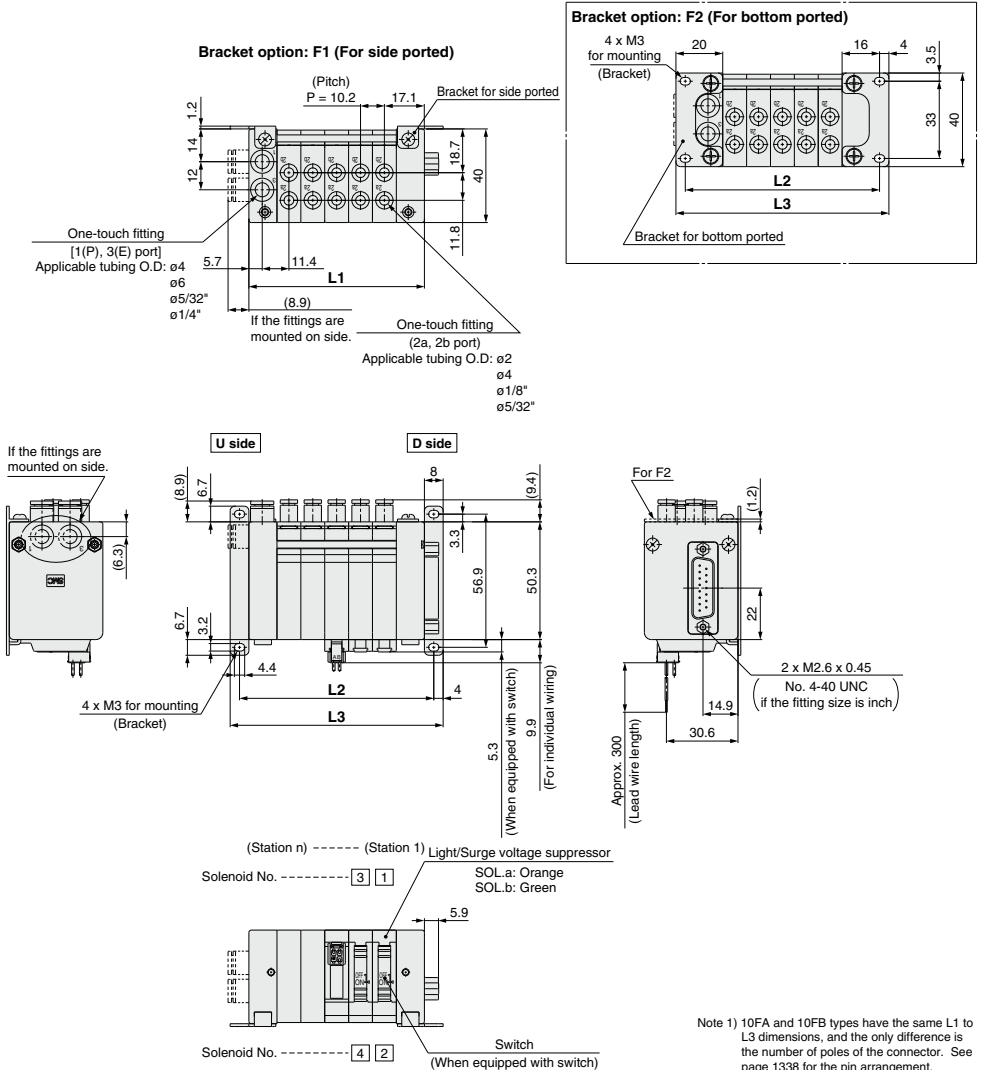

Note 1) 10FA and 10FB types have the same L1 to L3 dimensions, and the only difference is the number of poles of the connector. See page 1338 for the pin arrangement.

Note 2) For manifold dimensions including elbow fitting, see page 1343.

L: Dimensions

		n: Stations											
L	n	1	2	3	4	5	6	7	8	9	10	11	12
L1		34.2	44.4	54.6	64.8	75	85.2	95.4	105.6	115.8	126	136.2	146.4
L2		42.2	52.4	62.6	72.8	83	93.2	103.4	113.6	123.8	134	144.2	154.4
L3		50.2	60.4	70.6	80.8	91	101.2	111.4	121.6	131.8	142	152.2	162.4

3 Port Solenoid Valve/D-sub Connector

Plug-in Connector Type Manifold **VV100 Series**

VV100-10FAD2- Stations $U_2 - \frac{1}{2}$

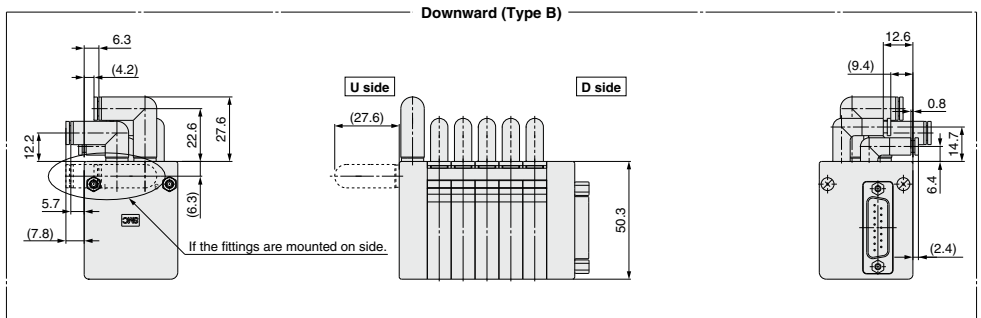
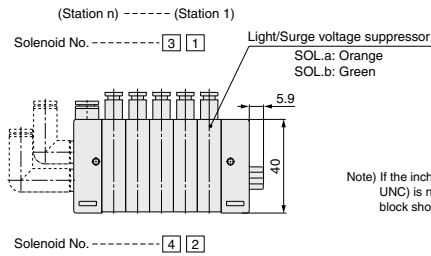
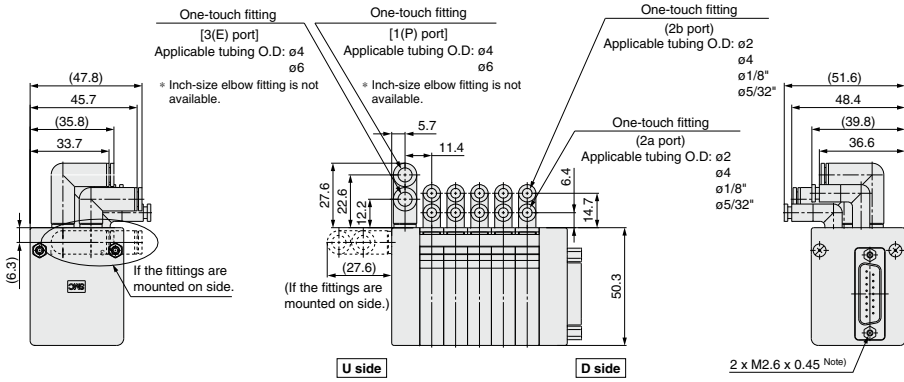
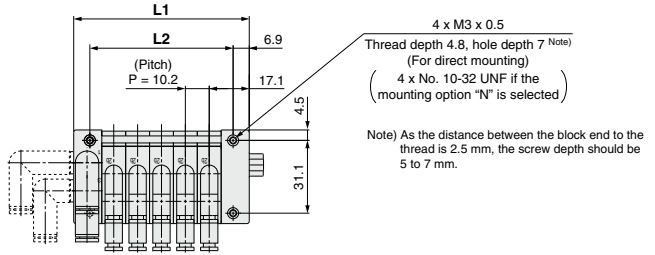

VV061

VV100

V100

S070

VQD

VQD-V

VK

VT

3 Port Solenoid Valve VV100 Series



Non Plug-in Individual Wiring Manifold

How to Order Manifold



VV100-10-05U1-C6

Valve stations

Symbol	Stations
01	1 station
⋮	⋮
12	12 stations

SUP/EXH block
mounting position: U side

SUP/EXH block fitting entry direction

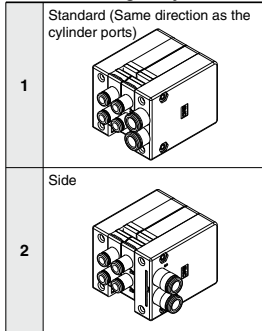

Note) If the mounted valve is N.O., apply pressure to the 3(E) port and exhaust air from the 1(P) port.

Mounting option

Symbol	Mounting
N11	Manifold direct mounting type With mounting nut M3 x 0.5
N (Note)	Manifold direct mounting type With mounting nut No. 10-32 UNF (Inch size)
F1	With bracket (Standard)
F2	With bracket (Port downward)

Note) If the mounting option "N" (Mounting nut: Inch size) is selected, the bracket cannot be mounted.

SUP/EXH block port size

One-touch fitting (Metric size)

C4	ø4 One-touch fitting (Straight)
C6	ø6 One-touch fitting (Straight)
L4	ø4 elbow fitting (Upward entry)
L6	ø6 elbow fitting (Upward entry)
B4	ø4 elbow fitting (Downward entry)
B6	ø6 elbow fitting (Downward entry)

One-touch fitting (Inch size)

N3	ø5/32" One-touch fitting (Straight)
N7	ø1/4" One-touch fitting (Straight)

How to Order Valve Manifold Assembly

Ordering example (VV100-10-□)

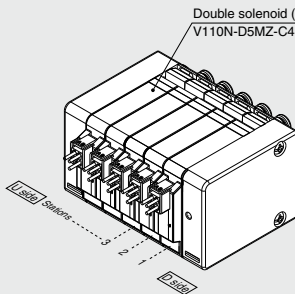

VV100-10-05U1-C6 1 set (Manifold part no.)
 * V110N-D5MZ-C4 5 sets (Double solenoid part no.)

The asterisk denotes the symbol for assembly.
 Prefix to the part no. of the solenoid valve, etc.

- The valve arrangement is numbered as the 1st station from D side.
- Indicate the valves to be attached below the manifold part number, in order starting from station 1 as shown in the drawing.



How to Order Valve Dedicated for Non Plug-in Individual Wiring

V110TND5 MZ-C4

Type of actuation

1	Normally closed (N.C.)
2	Normally open (N.O.)

* Normally closed and normally open type cannot be mounted on the same manifold.

Coil specification

Nll	Standard
T	With power saving circuit (Continuous duty type)

* Be certain to select "with power saving circuit" when the solenoid valve will be energized continuously for long periods of time.

Non plug-in

Number of solenoids

Symbol	Specifications
S	1 pc. (Single solenoid)
D	2 pcs. (Double solenoid)

Rated voltage

5	24 VDC
6	12 VDC

Common specification

Nll	+COM.
N	-COM.

Connector entry

M: Individual wiring, With lead wire
Length 300 mm

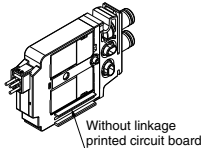

MN: Individual wiring, Without lead wire
(With connector, socket)

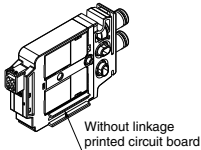

MO: Individual wiring, Without connector

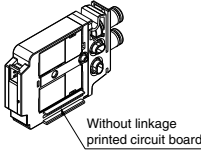

* When ordering a connector assembly separately, see pages 1355 and 1356.

2a/2b fitting port size

Straight fitting
(Metric size)
C2: ø2 One-touch fitting
C4: ø4 One-touch fitting
(Inch size)
N1: ø1/8" One-touch fitting
N3: ø5/32" One-touch fitting

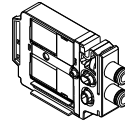

Elbow fitting (Upward entry)
(Metric size)

L2: ø2 One-touch fitting
L4: ø4 One-touch fitting
(Inch size)
LN1: ø1/8" One-touch fitting
LN3: ø5/32" One-touch fitting

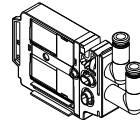

Elbow fitting (Downward entry)
(Metric size)

B2: ø2 One-touch fitting
B4: ø4 One-touch fitting
(Inch size)
BN1: ø1/8" One-touch fitting
BN3: ø5/32" One-touch fitting

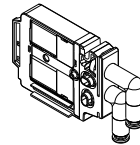

Light/Surge voltage suppressor

Z With light/surge voltage suppressor

VV061

VV100

V100

S070

VQD

VQD-V

VK

VT

VV100 Series

Dimensions

VV100-10-Stations U₁-

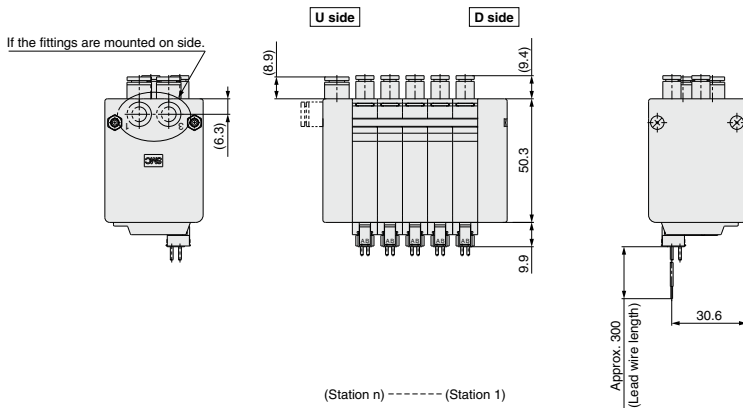
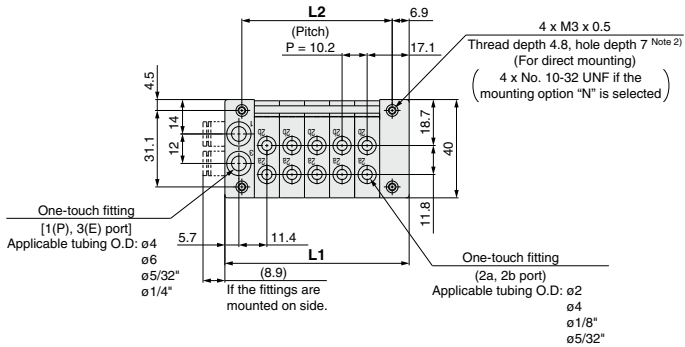

(Station n) ----- (Station 1)
Solenoid No. ----- 3 1

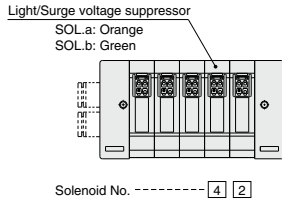

Note 1) For manifold dimensions including elbow fitting, see page 1343.

Note 2) As the distance between the block end to the thread is 2.5 mm, the screw depth should be 5 to 7 mm.

L: Dimensions

L	n: Stations											
	1	2	3	4	5	6	7	8	9	10	11	12
L1	34.2	44.4	54.6	64.8	75	85.2	95.4	105.6	115.8	126	136.2	146.4
L2	20.4	30.6	40.8	51	61.2	71.4	81.6	91.8	102	112.2	122.4	132.6

3 Port Solenoid Valve Non Plug-in Individual Wiring Manifold **VV100 Series**

VV100-10-**Stations** U₁-□□F₂

Bracket option: F1 (For side ported)

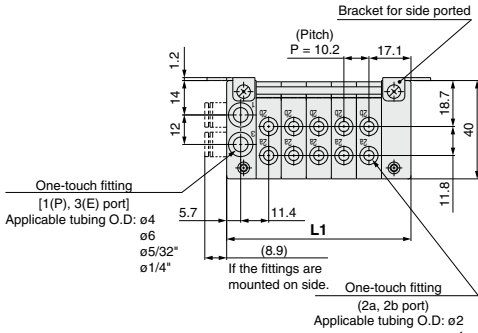

Bracket option: F2 (For bottom ported)

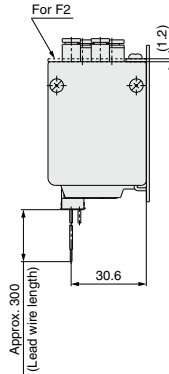
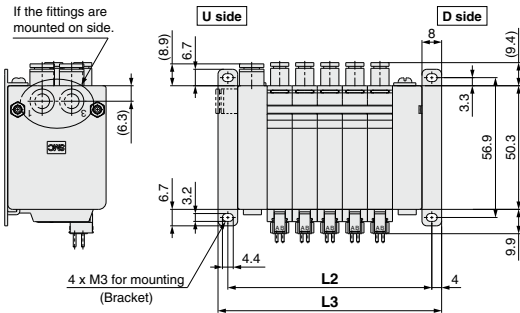
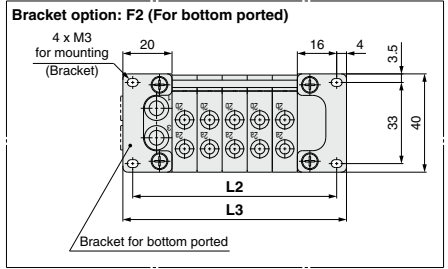

(Station n) ----- (Station 1)

Solenoid No. ----- **3 1**

Light/Surge voltage suppressor
SOL.a: Orange
SOL.b: Green

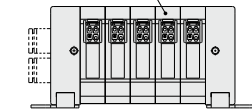

Solenoid No. ----- **4 2**

Note) For manifold dimensions including elbow fitting, see page 1343.

L: Dimensions

		n: Stations											
L	n	1	2	3	4	5	6	7	8	9	10	11	12
L1		34.2	44.4	54.6	64.8	75	85.2	95.4	105.6	115.8	126	136.2	146.4
L2		42.2	52.4	62.6	72.8	83	93.2	103.4	113.6	123.8	134	144.2	154.4
L3		50.2	60.4	70.6	80.8	91	101.2	111.4	121.6	131.8	142	152.2	162.4

VV061

VV100

V100

S070

VQD

VQD-V

VK

VT

VV100 Series

Manifold Exploded View

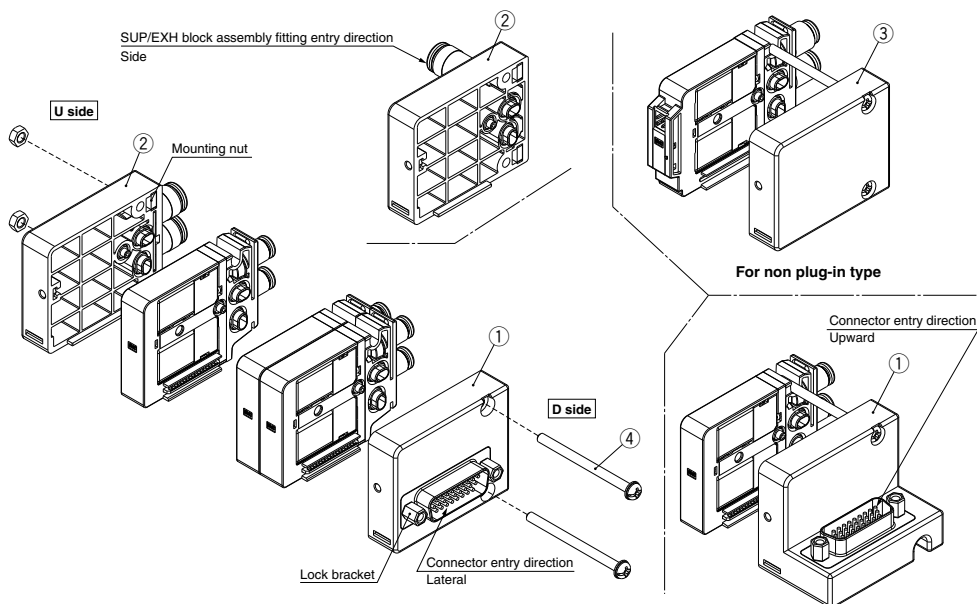

No.	Description	Part no.	Note
①	Connector block assembly ^{Note)} (For plug-in)	V100-192-□A□-15	Refer to Connector Block Assembly Part No. table below.
②	SUP/EXH end block assembly ^{Note)} (Common for plug-in and non plug-in types) <Fitting entry direction: Standard>	V100-193-1A-□ [Mounting nut (Metric size: M3)]	(Metric size) C4: ø4 One-touch fitting C6: ø6 One-touch fitting L4: ø4 elbow fitting (Upward entry) L6: ø6 elbow fitting (Upward entry) B4: ø4 elbow fitting (Downward entry) B6: ø6 elbow fitting (Downward entry)
		V100-193-2A-□ [Mounting nut (Inch size: No. 10-32 UNF)]	
②	SUP/EXH end block assembly ^{Note)} (Common for plug-in and non plug-in types) <Fitting entry direction: Side>	V100-193-3A-□ [Mounting nut (Metric size: M3)]	(Inch size) N3: ø5/32" One-touch fitting N7: ø1/4" One-touch fitting <Mounting nut part no. (4 pcs./set)> Metric size (M3): V100-197-1A Inch size (No. 10-32 UNF): V100-197-2A
		V100-193-4A-□ [Mounting nut (Inch size: No. 10-32 UNF)]	
③	End block assembly ^{Note)} (For non plug-in)	V100-199-1A [Mounting nut (Metric size: M3)]	
		V100-199-2A [Mounting nut (Inch size: No. 10-32 UNF)]	
④	Tension bolt (With hexagon nut)	V100-202-□A	□: Stations (1 to 12) 2 pcs./set

Note) If a bracket is intended to be mounted, select ① Connector block assembly, ② SUP/EXH end block assembly 1A or 3A, and ③ End block assembly 1A with mounting nut (Metric size: M3).

Connector Block Assembly Part No.

V100-192-□A□-□

Connector entry direction/Mounting nut thread type

Symbol	Thread type	Connector entry direction
1	Metric size (M3)	Lateral
2	Inch size (No. 10-32 UNF)	
3	Metric size (M3)	Upward
4	Inch size (No. 10-32 UNF)	

D-sub connector type

15	15 pins
26	26 pins

Lock bracket thread type

NII	Metric size (M2.6)
U	Inch size (No. 4-40 UNC)

Manifold Options

■ Bracket Assembly

V100-198-1A (For side ported)
 <Common for upward/
 lateral connectors>

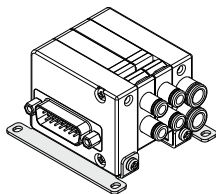

V100-198-3A (For bottom ported)
 <For lateral connector>

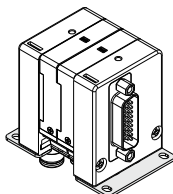

V100-198-4A (For bottom ported)
 <For upward connector>

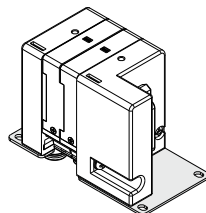

* The screws (M3) with which the bracket is mounted on the manifold are included.

■ Bracket Mounting Procedure

<For side ported>

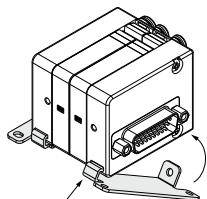

① Fit the bracket to the groove at the connector block (end block).

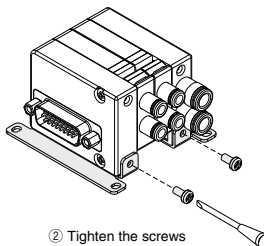

② Tighten the screws
 (Tightening torque M3:
 0.6 N·m).

<For bottom ported>

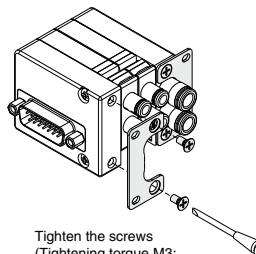

Tighten the screws
 (Tightening torque M3:
 0.6 N·m).

Note) The bracket can be mounted on the block with the mounting nut (Metric size: M3) only. It cannot be mounted on the block with inch-size mounting nut (No. 10-32 UNF).

VV061

VV100

V100

S070

VQD

VQD-V

VK

VT

VV100 Series

Manifold Options

■ Mounting Example

Manifold direct mounting

SUP/EXH block fitting entry direction: Standard

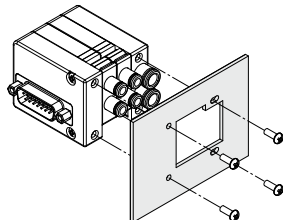

Panel fitting dimensions/Mounting hole dimensions

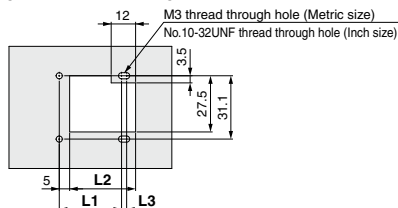

Station n	1	2	3	4	5	6	7	8	9	10	11	12
L1	20.4	30.6	40.8	51	61.2	71.4	81.6	91.8	102	112	122	133
L2	22.4	32.8	43.2	53.6	64	74.4	84.8	95.2	106	116	126	137
L3	1.3							2.5				

(Reference dimension)

SUP/EXH block fitting entry direction: Side

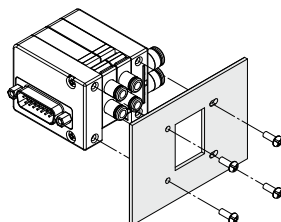

Panel fitting dimensions/Mounting hole dimensions

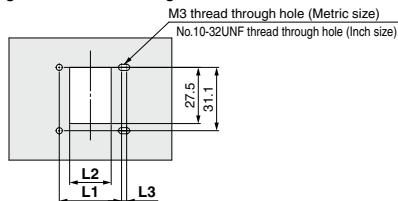

Station n	1	2	3	4	5	6	7	8	9	10	11	12
L1	20.4	30.6	40.8	51	61.2	71.4	81.6	91.8	102	112	122	133
L2	10.4	20.8	31.2	41.6	52	62.4	72.8	83.2	93.6	104	114	125
L3	1.3							2.5				

(Reference dimension)

Bracket mounting (For bottom ported)

Upward connector

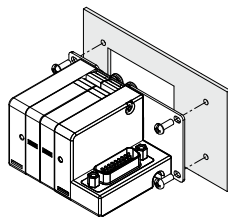

Panel fitting dimensions/Mounting hole dimensions

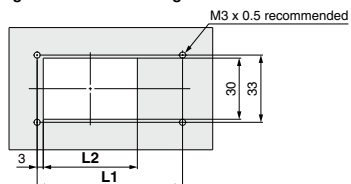

Station n	1	2	3	4	5	6	7	8	9	10	11	12
L1	61.2	71.4	81.6	91.8	102	112	122	133	143	153	163	173
L2	36.2	46.6	57	67.4	77.8	88.2	98.6	109	119	130	140	151

(Reference dimension)

Lateral connector

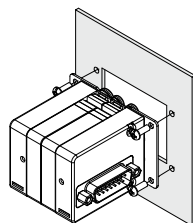

Panel fitting dimensions/Mounting hole dimensions

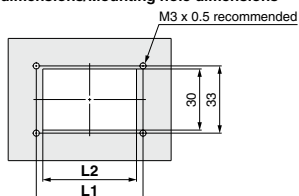

Station n	1	2	3	4	5	6	7	8	9	10	11	12
L1	52.4	62.6	72.8	83	93.2	103	114	124	134	144	154	165
L2	36.2	46.6	57	67.4	77.8	88.2	98.6	109	119	130	140	151

(Reference dimension)

Manifold Options

D-sub connector cable assembly

For 15 pins V100-DS15-□□□ (N)

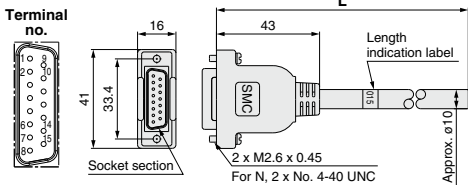

For 26 pins V100-DS26-□□□ (N)

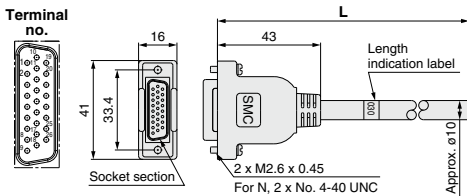

D-sub Connector Cable Assembly

Cable length L	Assembly part no.	Note
1.5 m	V100-DS15-015(N)	Cable 15 cores X23AWG
3 m	V100-DS15-030(N)	
5 m	V100-DS15-050(N)	

Note) For N, the unified thread is used.

For other commercial connectors, use a 15 pin type with female connector conforming to MIL-C24308.

D-sub Connector Cable Assembly

Cable length L	Assembly part no.	Note
1.5 m	V100-DS26-015(N)	Cable 26 cores X23AWG
3 m	V100-DS26-030(N)	
5 m	V100-DS26-050(N)	

Note) For N, the unified thread is used.

D-sub Connector Cable Assembly Cable Color List of Each Terminal No.

Terminal no.	Lead wire color	Dot marking
1	Black	None
2	Brown	None
3	Red	None
4	Orange	None
5	Yellow	None
6	Pink	None
7	Blue	None
8	Purple	White
9	Gray	Black
10	White	Black
11	White	Red
12	Yellow	Red
13	Orange	Red
14	Yellow	Black
15	Pink	Black

D-sub Connector Cable Assembly Cable Color List of Each Terminal No.

Terminal no.	Lead wire color	Dot marking
1	Black	None
2	Brown	None
3	Red	None
4	Orange	None
5	Yellow	None
6	Pink	None
7	Blue	None
8	Purple	White
9	Gray	Black
10	White	Black
11	White	Red
12	Yellow	Red
13	Orange	Red
14	Yellow	Black
15	Pink	Black
16	Blue	White
17	Purple	None
18	Gray	None
19	Orange	Black
20	Red	White
21	Brown	White
22	Pink	Red
23	Gray	Red
24	Black	White
25	White	None
26	Light blue	None

Electric Characteristics

Item	Characteristics
Conductor resistance Ω/km, 20°C	65 or less
Withstand pressure V, 1 min, AC	1000
Insulation resistance MΩ/km, 20°C	5 or more

* The minimum bending radius for D-sub connector cables is 20 mm.

VV061

VV100

V100

S070

VQD

VQD-V

VK

VT



VV100 Series Specific Product Precautions 1

Be sure to read this before handling the products.

Refer to back page 50 for Safety Instructions and pages 3 to 9 for 3/4/5 Port Solenoid Valve Precautions.

Valve with Switch

Warning

When turning off the valve using the switch, move it to the position where the valve is locked. If the switch is at an improper position and is energized, equipment connected to the valve could be actuated.

Also, if the switch is turned OFF on the valve in the energized state, be careful because any actuators connected will actuate.

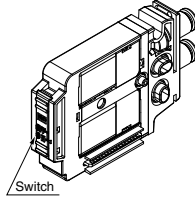

ON position



Normal operation: The valve is switched according to electric signals from the connector on the manifold side.

OFF position



The valve coil is kept in a deenergized state even when there is an electric signal from the connector on the manifold side.

Electric circuit diagram (with positive common and light/surge voltage suppressor)

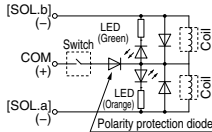

(with negative common and light/surge voltage suppressor)

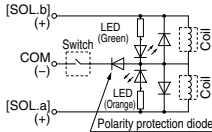

Light/Surge Voltage Suppressor

Caution

Non-Polar Type

Single solenoid

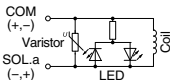

Double solenoid

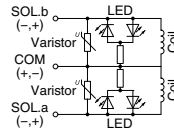

Positive Common

Single solenoid

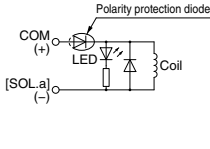

Double solenoid

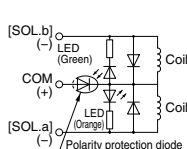

Negative Common

Single solenoid

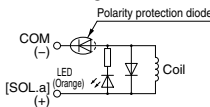

Double solenoid

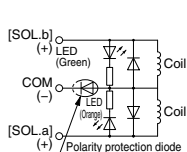

Countermeasure for Surge Voltage Intrusion

Caution

With non-polar type solenoid valves, at times of sudden interruption of the loading power supply, such as emergency shutdown, surge voltage intrusion may be generated from loading equipment with a large capacity (power consumption), and the solenoid valve in a deenergized state may switch over (see Figure 1). When installing a breaker circuit for the loading power supply, consider using a solenoid valve with polarity (with polarity protection diode), or install a surge absorption diode between the loading equipment COM line and the output equipment COM line (see Figure 2).

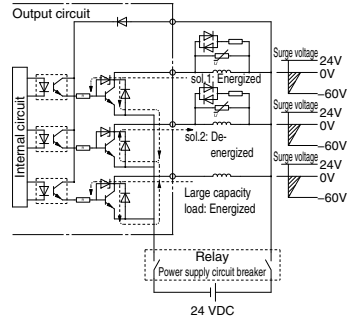

Figure 1. Surge intrusion circuit example (24 VDC)

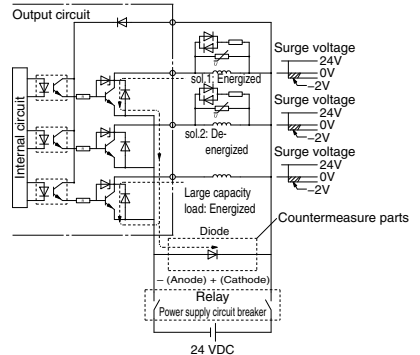

Figure 2. Surge intrusion circuit example (24 VDC)

Continuous Duty

Caution

If a valve is energized continuously for long periods of time, the rise in temperature due to heat-up of the coil may cause a decline in solenoid valve performance, reduce service life, or have adverse effects on peripheral equipment. If a valve will be energized continuously, be sure to use the "Continuous duty type" with a power saving circuit. In particular, there will be a large increase in temperature if 3 or more neighboring stations are simultaneously energized continuously for long periods of time, or if the a and b sides are simultaneously energized continuously for long periods of time. Be very careful in such cases.



VV100 Series Specific Product Precautions 2

Be sure to read this before handling the products.

Refer to back page 50 for Safety Instructions and pages 3 to 9 for 3/4/5 Port Solenoid Valve Precautions.

Continuous Duty

⚠ Caution

■ With Power Saving Circuit

Compared to the standard products, power consumption is reduced down to approx. 1/3 (V1□0T) by cutting the unnecessary wattage required to hold the valve in an energized state. (Effective energizing time is over 67 ms at 24 VDC.)

Electric circuit diagram (with power saving circuit)

Positive common, single solenoid

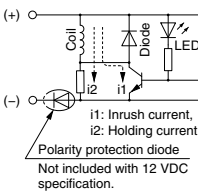

Negative common, single solenoid

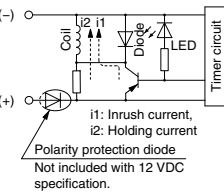

Working Principle

With the circuit above, the current consumption, when holding, is reduced to save energy. Refer to the electric wave data below.

Power waveform of power saving type (V1□0T)

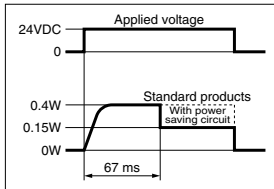

- When a power saving circuit is installed, a diode to prevent reverse current is not available for 12 V DC specification. Therefore, use caution not to connect in reverse.
- Be careful about the allowable voltage fluctuation since a voltage drop of about 0.5 V occurs due to a transistor. (Refer to the solenoid specifications of each valve for details.)

Light Indication

⚠ Caution

When equipped with light/surge voltage suppressor, the light window turns orange when solenoid a is energized, and it turns green when solenoid b is energized.

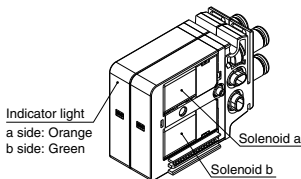

Fitting Replacement

⚠ Caution

By replacing a valve's fitting, it is possible to change the port size of the 2a, 2b, 1(P), and 3(E) ports. When replacing it, pull out the fitting after removing the clip or the plate with a flat head screwdriver, etc. To mount a new fitting, insert it into place and then fully reinsert the clip or the plate.

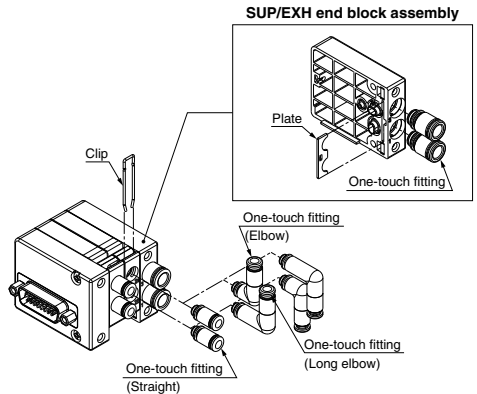

One-touch Fitting Part No.

Metric Size

Port	Port size	Part no.
2(a)	ø2 One-touch fitting (Straight)	KJH02-C1
	ø4 One-touch fitting (Straight)	KJH04-C1
	ø2 One-touch fitting (Elbow)	KJL02-C1
	ø4 One-touch fitting (Elbow)	KJL04-C1-N
2(b)	ø2 One-touch fitting (Long elbow)	KJW02-C1
	ø4 One-touch fitting (Long elbow)	KJW04-C1-N
1(P) 3(E)	ø4 One-touch fitting (Straight)	VVQ1000-50A-C4
	ø6 One-touch fitting (Straight)	VVQ1000-50A-C6
	ø4 One-touch fitting (Elbow)	SZ3000-73-1A-L4
	ø6 One-touch fitting (Elbow)	SZ3000-73-1A-L6
	ø4 One-touch fitting (Long elbow)	SZ3000-73-2A-L4
	ø6 One-touch fitting (Long elbow)	SZ3000-73-2A-L6

Inch Size

Port	Port size	Part no.
2(a)	ø1/8" One-touch fitting (Straight)	KJH01-C1
2(b)	ø5/32" One-touch fitting (Straight)	KJH03-C1
1(P)	ø5/32" One-touch fitting (Straight)	VVQ1000-50A-N3
3(E)	ø1/4" One-touch fitting (Straight)	VVQ1000-50A-N7

- Note 1) Be careful to avoid damage or contamination to the O-rings, as this can cause air leakage.
- Note 2) When removing a straight fitting from a valve, after removing the clip, attach tubing or a plug (KJP-02, KO2P-□□) to the one-touch fitting, and pull it out while holding the tubing or plug. If it is pulled out while holding the release button of the fitting (resin part), the release button may be damaged.
- Note 3) Be sure to turn off the power and stop the supply of air before disassembly. Furthermore, since air may remain inside the actuator, piping and manifold, confirm that the air is completely exhausted before starting any work.
- Note 4) While inserting a tubing into an elbow fitting, hold the main body of the assembly by hand. Failure to do so will exert an undue force on the valve or the fitting, resulting in air leakage or damage.



VV100 Series

Specific Product Precautions 3

Be sure to read this before handling the products.

Refer to back page 50 for Safety Instructions and pages 3 to 9 for 3/4/5 Port Solenoid Valve Precautions.

One-touch Fittings

⚠ Caution

1. Tube attachment/detachment for one-touch fittings

1) Attaching of tubing

- (1) Take a tube having no flaws on its periphery and cut it off at a right angle. When cutting the tube, use tube cutters TK-1, 2 or 3. Do not use pinchers, nippers or scissors, etc. If cutting is done with tools other than tube cutters, there is the danger that the tube may be cut diagonally or become flattened, etc., making a secure installation impossible, and causing problems such as the tube pulling out after installation or air leakage. Also allow some extra length in the tube.

- (2) Grasp the tube and push it in slowly, inserting it securely all the way into the fitting.

- (3) After inserting the tube, pull on it lightly to confirm that it will not come out. If it is not installed securely all the way into the fitting, this can cause problems such as air leakage or the tube pulling out.

2) Detaching of tubing

- (1) The 2a and 2b ports use the KJ series, so the tube can be removed by pressing on part of the release button. However, for the 1(P) and 3(E) ports, press the release button evenly as before.

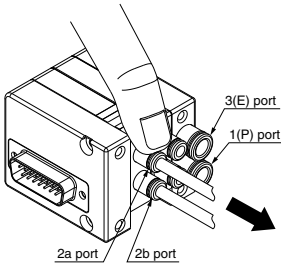

Hold down part of the release button with your finger or a similar tool, as shown in the diagram, and pull out in the direction indicated by the arrow.

- (2) Pull out the tube while holding down the release button so that it does not come out. If the release button is not pressed down sufficiently, there will be increased bite on the tube and it will become more difficult to pull it out.

- (3) When the removed tube is to be used again, cut off the portion which has been chewed before reusing it. If the chewed portion of the tube is used as is, this can cause trouble such as air leakage or difficulty in removing the tube.

Other Tubing Brands

⚠ Caution

1. When using tube other than SMC brand, confirm the following specifications are satisfied with respect to the outside diameter tolerance of the tube.

- 1) Nylon tubing within ± 0.1 mm
- 2) Soft nylon tubing within ± 0.1 mm
- 3) Polyurethane tubing within $+0.15$ mm, within -0.2 mm

Do not use tubing which does not meet these outside diameter tolerances. It may not be possible to connect them, or they may cause other troubles, such as air leakage or the tube pulling out after connection.

How to Use Plug Connector

⚠ Caution

When attaching and detaching a connector, first shut off the electric power and the air supply. Also, crimp the lead wires and sockets securely.

1. Attaching and detaching connectors

- To attach a connector, hold the lever and connector unit between your fingers and insert straight onto the pins of the solenoid valve so that the lever's pawl is pushed into the groove and locks.
- To detach a connector, remove the pawl from the groove by pushing the lever downward with your thumb, and pull the connector straight out.

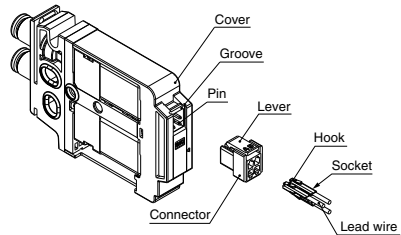

2. Crimping of lead wires and sockets

Peel 3.2 to 3.7 mm of the tip of lead wire, enter the core wires neatly into a socket and crimp it with a special crimp tool. Be careful so that the cover of lead wire does not enter into the crimping part. (Crimping tool: Model no. DXT170-75-1)

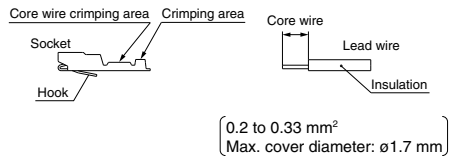



VV100 Series

Specific Product Precautions 4

Be sure to read this before handling the products.

Refer to back page 50 for Safety Instructions and pages 3 to 9 for 3/4/5 Port Solenoid Valve Precautions.

How to Use Plug Connector

⚠ Caution

3. Attaching and detaching lead wires with sockets

• Attaching

Insert the sockets into the square holes of the connector (with A, B, C, and N indication), and continue to push the sockets all the way in until the lock by hooking into the seats in the connector. (When they are pushed in, their hooks open and they are locked automatically.) Next, confirm that they are locked by pulling lightly on the lead wires.

• Detaching

To detach a socket from a connector, pull out the lead wire while pressing the socket's hook with a stick having a thin tip (approx. 1 mm). If the socket is used again, spread the hook outward.

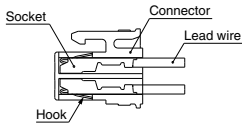

<Positive common>

Single solenoid

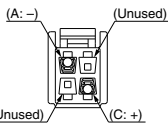

Double solenoid

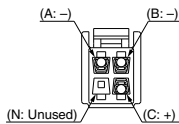

<Negative common>

Single solenoid

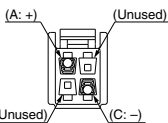

Double solenoid

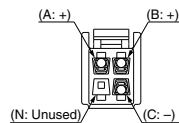

Plug Connector Lead Wire Length

⚠ Caution

Plug connector lead wires have a standard length of 300 mm, however, the following lengths are also available.

■ Connector Assembly Part No.

For single solenoid

SJ3000-46-S-□ (for positive common)

SJ3000-47-S-□ (for negative common)

For double solenoid

SJ3000-46-D-□ (for positive common)

SJ3000-47-D-□ (for negative common)

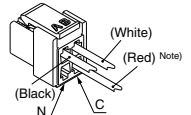
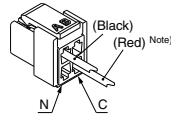
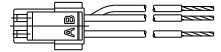
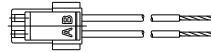

Note) In case of negative common, the lead wire changes from red to yellow.

Lead wire length	
Nil	300 mm
6	600 mm
10	1000 mm
15	1500 mm
20	2000 mm
25	2500 mm
30	3000 mm
50	5000 mm

For single solenoid: SJ3000-46-S-□

For double solenoid: SJ3000-46-D-□

Common specifications

46	For positive common
47	For negative common

For single solenoid

Without lead wire: SJ3000-46-S-N
(positive/negative common)
(Connector, Socket x 2 pcs. only)

For double solenoid

Without lead wire: SJ3000-46-D-N
(positive/negative common)
(Connector, Socket x 3 pcs. only)

■ How to Order

Include the connector assembly part number together with the part number for the plug connector's solenoid valve without connector.

(Example) In case of lead wire length 2000 mm and positive common
V110N-D5MOZ-C4
SJ3000-46-D-20

VV061

VV100

V100

S070

VQD

VQD-V

VK

VT



VV100 Series Specific Product Precautions 5

Be sure to read this before handling the products.

Refer to back page 50 for Safety Instructions and pages 3 to 9 for 3/4/5 Port Solenoid Valve Precautions.

Connector Assembly for Manifolds (for Junction Common)

⚠ Caution

Using the connector assembly (for junction common) for solenoid valves installed in the manifold reduces the labor involved in wiring work because common wiring for all solenoid valves is integrated into a single wire.

■ Connector Assembly Part No. (for Junction Common)

For single solenoid

SJ3000-46-SC-□ (for positive common)

SJ3000-47-SC-□ (for negative common)

For double solenoid

SJ3000-46-DC-□ (for positive common)

SJ3000-47-DC-□ (for negative common)

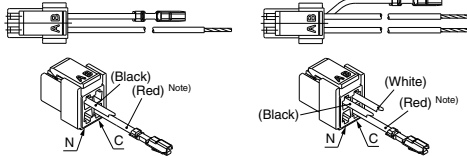

Note) In case of negative common, the lead wire changes from red to yellow.

		Lead wire length	
For single solenoid: SJ3000-46-SC-□	46	Nil	300 mm
		6	600 mm
		10	1000 mm
		15	1500 mm
		20	2000 mm
		25	2500 mm
		30	3000 mm
		50	5000 mm

Common specifications	
46	For positive common
47	For negative common

For junction common

■ How to Order

Indicate the part no. of the connector assembly for the manifold and solenoid valve.

If the arrangement is complicated, specify them by means of the manifold specification sheet.

Note 1) Applications like connectors not wired to a valve is not possible.

Note 2) For the solenoid valve, designate "Without connector (MOZ)" for the connector type.

Note 3) Connector assembly with lead wire for place where the signals are transmitted to the common wiring. (Only the valves of first station and/or last station of manifold are compatible to connector with lead wire for common.)

Wiring Procedure for Connector Assembly (for Junction Common)

⚠ Caution

If only connector assembly (for junction common) is ordered, please wire according to the instructions in the diagram below. For details on socket mounting, refer to "How to Use Plug Connector" on the page 1355.

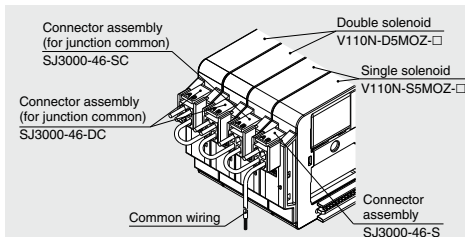
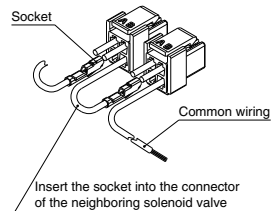

(Example)

- VV100-10-04U1-C6 1 set
- * V110N-S5MOZ-C4 2 sets
- * V110N-D5MOZ-C4 2 sets
- * SJ3000-46-S 1 set (Connector assembly for single solenoid)
- * SJ3000-46-SC 1 set (Connector assembly for single solenoid) (for junction common)
- * SJ3000-46-DC 2 sets (Connector assembly for double solenoid) (for junction common)

The asterisk denotes the symbol for assembly. Prefix it to the part nos. of the solenoid valve, etc.