

5 Port Solenoid Valve

VQ4000/5000 Series

Metal Seal

Rubber Seal

Installation volume

42% Reduction

Installation area

26% Reduction

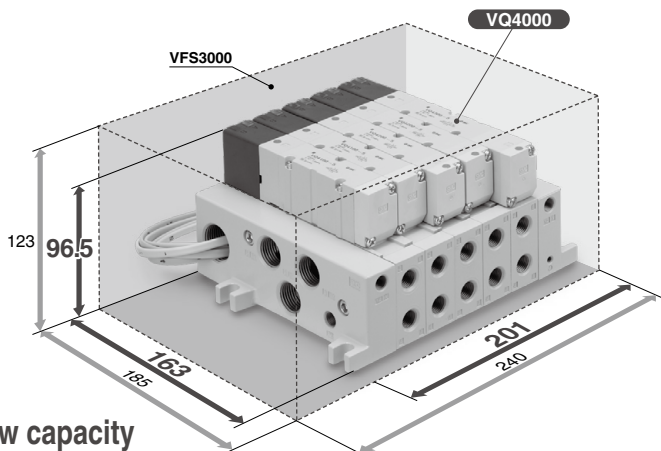

- Compact and large flow capacity

VQ4000 Possible to drive cylinders up to $\varnothing 160^*$

VQ5000 Possible to drive cylinders up to $\varnothing 180^*$ * When the average speed is 200 mm/s. Refer to page 448 for actual conditions.



VQ4000: 25 mm pitch

C[dm³/(s·bar)]: 7.3*

VQ5000: 41 mm pitch

C[dm³/(s·bar)]: 17*

* 2-position single, rubber seal, 4/2 → 5/3 (A/B → R1/R2)

- Power saving

	Power consumption [W]	Maximum operating pressure [MPa]
VQ	0.4 (0.95)	1.0
Current product	0.5 (1.0)	0.7

* Low wattage type () : Standard

- Long service life

100 million cycles
(Metal seal)

* According to SMC life test conditions

- Enclosure IP65 compliant
Dust-tight/Water-jet-proof

* When manifold is IP65 compliant.

* Except F and T1 kits

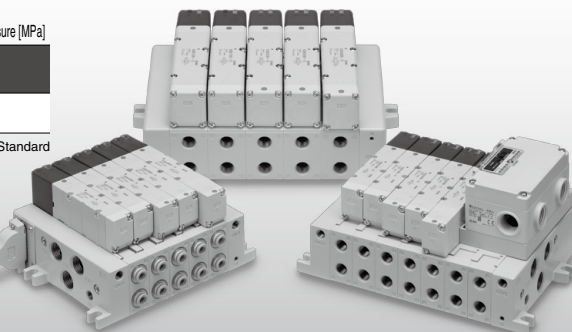

- SV
- SYJ
- SZ
- VF
- VP4
- VQ 1/2
- VQ 4/5
- VQC 1/2
- VQC 4/5
- VQZ
- SQ
- VFS
- VFR
- VQ7

Base Mounted Type Variations

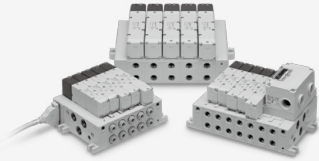

Valve Specifications

Sonic conductance C[dm ² /(s-bar)] 4/2 → 5/3 (A/B → EA/EB)		Wiring						Type of actuation											
		Plug-in						Plug lead	Single	Double	Closed center	Exhaust center	Pressure center	Double check					
		Single	Double	3-position (Closed center)	D-sub connector	Terminal block box	Lead wire								Serial transmission	With individual terminal blocks			
Series VQ4000 Page 450	Metal Seal	VQ4□00	6.9	6.3															
	Rubber Seal	VQ4□01	7.3	6.4	●	●	●	●	—	●	●	●	●	●	●	●	●	●	●
Series VQ5000 Page 492	Metal Seal	VQ5□00	14	11															
	Rubber Seal	VQ5□01	17	13	●	●	●	●	●	●	●	●	●	●	●	●	●	●	●

Plug-in/Plug Lead

Wiring

Common wiring/Plug-in

D-sub connector

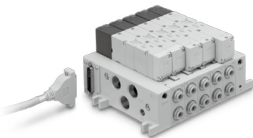

Terminal block box

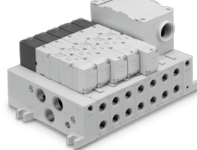

IP65

Lead wire

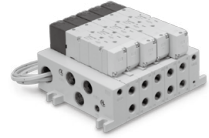

IP65

Common wiring/Plug-in

Serial transmission

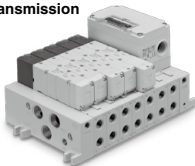

IP65

Individual wiring/Plug lead

Connector

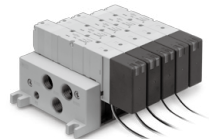

IP65

With individual terminal blocks
(VQ5000 only)

VQ4000/5000 Series

Voltage		Electrical entry		Manual override			Semi-standard	With Control Unit	Manifold Options										
12, 24 VDC	100, 110 VAC (50/60 Hz)	200, 220 VAC (50/60 Hz)	Plug-in	Grommet	Push type/Tool required	Locking type/Tool required	Locking type/Manual	External pilot	Manifold	Blanking plate assembly	Individual SUP/EXH spacer	Restrictor spacer	SUP stop valve spacer	Release valve spacer: For D side mounting	SUP/EXH block plate	Direct exhaust with silencer box	Double check spacer with residual pressure exhaust	Manifold mounted with exhaust cleaner	Interface regulator (P, A, B port regulation)
●	● (Except S kit)	● (Except S kit)	●	●	●	●	●	P.481	P.482	P.476	P.476	P.477	P.477	P.477	P.477	P.478	P.478	P.479	P.480
●	● (Except S kit)	● (Except S kit)	●	●	●	●	●	P.527	—	P.522	P.522	P.523	P.523	P.523	P.523	P.524	P.524	P.525	P.526

- SV
- SYJ
- SZ
- VF
- VP4
- VQ 1/2
- VQ 4/5
- VQC 1/2
- VQC 4/5
- VQZ
- SQ
- VFS
- VFR
- VQ7

Manifold with Control Unit **Manifold Options** (Page 476) (VQ4000) (Page 522) (VQ5000)

Page 482

Air filter, regulator and equipment for controlling the air release valve pressure switch in one unit reduced piping work.



Blanking plate assembly

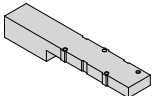

Individual SUP spacer
Individual EXH spacer
<Individual SUP spacer>

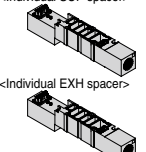

Restrictor spacer

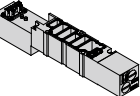

SUP stop valve spacer

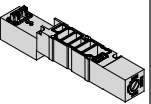

Release valve spacer:
For D side mounting

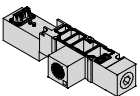

SUP/EXH block plate

EXH block plate (Order qty: 2 pcs.)

SUP block plate

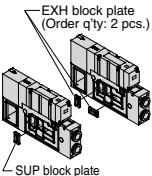

Direct exhaust with silencer box

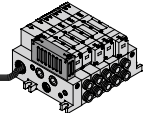

Double check spacer with residual pressure exhaust

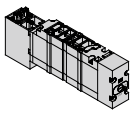

Manifold mounted with exhaust cleaner

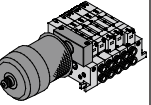

Interface regulator
(P, A, B port regulation)

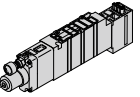

Cylinder Speed Chart

This chart is provided as guidelines only.

For performance under various conditions, use SMC's Model Selection Software before making a judgment.

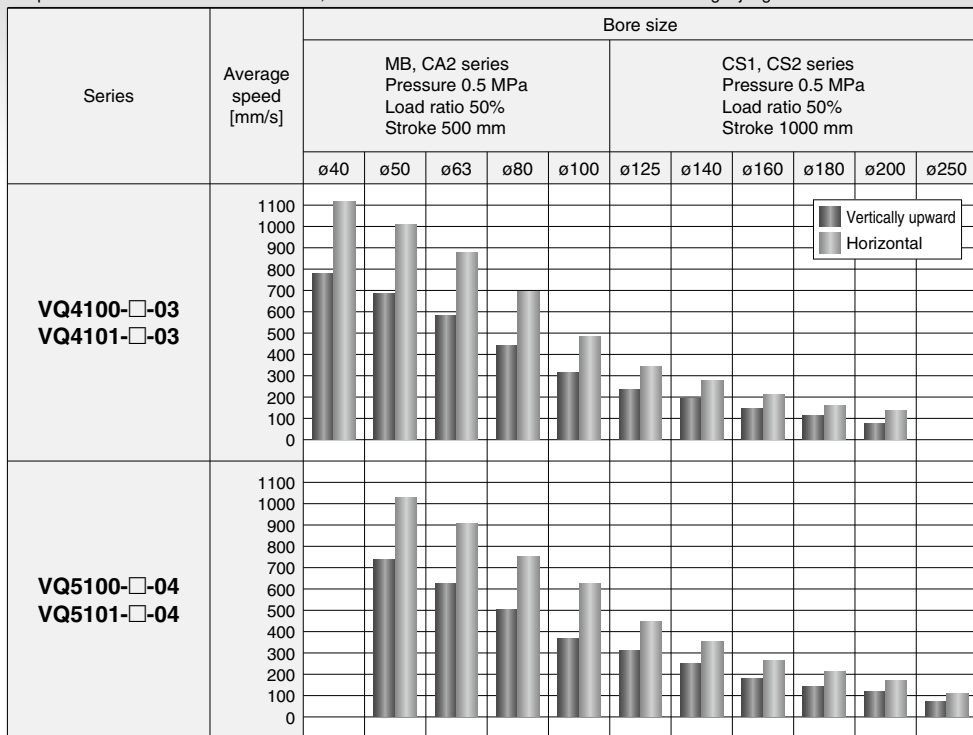

* Values at extension of a directly coupled cylinder when meter-out speed controllers are used with the needle full open.

* The average speed of the cylinder is obtained by dividing the stroke by the total stroke time.

* The load ratio is obtained by the following formula: $((\text{Load mass} \times 9.8) / \text{Theoretical output}) \times 100\%$

Conditions

Series	Condition	MB, CA2 series	CS1, CS2 series
VQ4100-□-03 VQ4101-□-03	SGP (Steel pipe) dia. x Length	10A x 1 m	
	Speed controller	AS420-03	
	Silencer	AN30-03	
VQ5100-□-04 VQ5101-□-04	SGP (Steel pipe) dia. x Length	10A x 1 m	
	Speed controller	AS420-04	
	Silencer	AN40-04	



INDEX

Base Mounted Type Variations	Page 446
Cylinder Speed Chart	Page 448

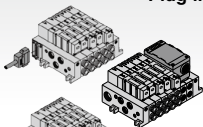
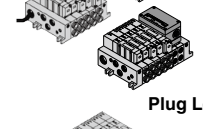
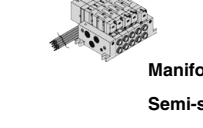
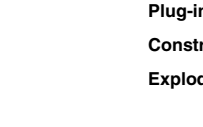
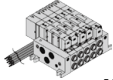
VQ4000 Series

Plug-in/Plug Lead Single Unit Model, Standard Specifications	Page 450
Plug-in Unit Manifold How to Order, Specifications, Manifold Options	Page 454
 F Kit (D-sub connector kit) [IP40]	Page 456
 T Kit (Terminal block box kit) [IP65]	Page 460
 L Kit (Lead wire cable) [IP65]	Page 464
 S Kit (Serial transmission unit): EX123/124 [IP65]	Page 468
Plug Lead Unit	
 C Kit (Connector kit) [IP65]	Page 472
Manifold Options	Page 476
Semi-standard Specifications	Page 481
Plug-in/Plug Lead Manifold with Control Unit	Page 482
Construction	Page 486
Exploded View of Manifold	Page 488

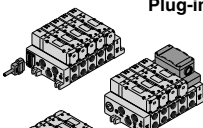
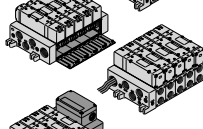
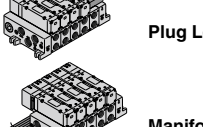
VQ5000 Series

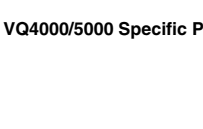
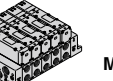
Plug-in/Plug Lead Single Unit Model, Standard Specifications	Page 492
Plug-in Unit Manifold How to Order, Specifications, Manifold Options	Page 496
 F Kit (D-sub connector kit) [IP40]	Page 498
 T Kit (Terminal block box kit) [IP65]	Page 502
 T1 Kit (Individual terminal block kit) [IP40]	Page 506
 L Kit (Lead wire cable) [IP65]	Page 510
 S Kit (Serial transmission unit): EX123/124 [IP65]	Page 514
Plug Lead Unit	
 C Kit (Connector kit) [IP65]	Page 518
Manifold Options	Page 522
Semi-standard Specifications	Page 527
Construction	Page 528
Exploded View of Manifold	Page 530

VQ4000/5000 Specific Product Precautions	Page 533
---	----------

SV
SYJ
SZ
VF
VP4
VQ 1/2
VQ 4/5
VQC 1/2
VQC 4/5
VQZ
SQ
VFS
VFR
VQ7

Base Mounted

Plug-in/Plug Lead: Single Unit

VQ4000 Series



[Option]
Note) CE-compliant:
For DC only.

Model

Series	Configuration	Model		Port size	Flow rate characteristics						Response time [ms]			Weight [kg]		
					1 → 4/2 (P → A/B)			4/2 → 5/3 (A/B → EA/EB)			Standard: 0.95 W	Low voltage type: 0.4 W	AC			
					C [dm ³ /(s·bar)]	b	Cv	C [dm ³ /(s·bar)]	b	Cv						
VQ4000	2-position	Single	Metal seal	VQ41 ⁰ ₅ 0	3/8	6.2	0.19	1.5	6.9	0.17	1.7	20	22	22	0.23 (0.29)	
			Rubber seal	VQ41 ⁰ ₅ 1		7.2	0.43	2.1	7.3	0.38	2.0	25	27	27		
		Double	Metal seal	VQ42 ⁰ ₅ 0		6.2	0.19	1.5	6.9	0.17	1.7	12	16	14		0.26 (0.32)
			Rubber seal	VQ42 ⁰ ₅ 1		7.2	0.43	2.1	7.3	0.38	2.0	15	17	17		
	3-position	Closed center	Metal seal	VQ43 ⁰ ₅ 0		5.9	0.23	1.5	6.3	0.18	1.6	45	47	47	0.28 (0.34)	
			Rubber seal	VQ43 ⁰ ₅ 1		7.0	0.34	1.9	6.4	0.42	1.9	50	52	52		
		Exhaust center	Metal seal	VQ44 ⁰ ₅ 0		6.2	0.18	1.5	6.9	0.17	1.7	45	47	47	0.28 (0.34)	
			Rubber seal	VQ44 ⁰ ₅ 1		7.0	0.38	1.9	7.3	0.38	2.0	50	52	52		
		Pressure center	Metal seal	VQ45 ⁰ ₅ 0		6.2	0.18	1.6	6.4	0.18	1.6	45	47	47	0.28 (0.34)	
			Rubber seal	VQ45 ⁰ ₅ 1		7.0	0.38	1.9	7.1	0.38	2.0	50	52	52		
		Double check	Metal seal	VQ46 ⁰ ₅ 0		2.7	—	—	3.7	—	—	55	57	57	0.50 (0.56)	
			Rubber seal	VQ46 ⁰ ₅ 1		2.8	—	—	3.9	—	—	62	64	64		

Note 1) Value for valve on sub-plate and cylinder port 3/8

Note 2) Based on JIS B 8419: 2010. (Supply pressure: 0.5 MPa, with indicator light and surge voltage suppressor, clean air. This will change depending on pressure and air quality.) The value when ON for the double type.

Note 3) Values inside () indicate the weight of plug lead units.

Table: Without sub-plate, With sub-plate: Add 0.41 kg for plug-in type, 0.30 kg for plug lead type.

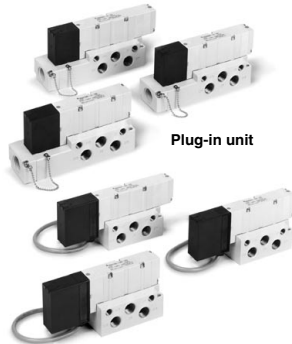

Plug-in unit

Plug lead unit

Symbol

2-position single

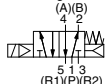

3-position closed center

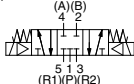

2-position double (Metal)

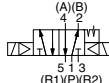

3-position exhaust center

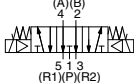

2-position double (Rubber)

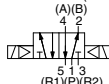

3-position pressure center

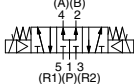

3-position double check

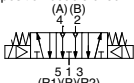

Standard Specifications

Valve specifications	Valve construction		Metal seal	Rubber seal	
	Fluid	Air/Inert gas			
Max. operating pressure	1.0 MPa				
Min. operating pressure	Single	0.15 MPa	0.20 MPa		
	Double	0.15 MPa	0.15 MPa		
	3-position	0.15 MPa	0.20 MPa		
Ambient and fluid temperature	-10 to 50°C ^{Note 1)}				
Lubrication	Not required				
Manual override	Push type/Locking type (Tool required)				
Impact/Vibration resistance	150/30 m/s ² ^{Note 2)}				
Enclosure	Dust-tight (IP65 compatible) ^{Note 3)}				
Electrical specifications	Coil rated voltage		12, 24 VDC, 100, 110, 200, 220 VAC (50/60 Hz)		
	Allowable voltage fluctuation		±10% of rated voltage		
	Coil insulation type		Class B or equivalent		
	Power consumption [W]	DC	Standard	0.95	
			Low voltage type	0.4	
Apparent power [VA]	AC	100 V	1.19		
		110 V	1.32		
		200 V	1.90		
		220 V	2.08		

Note 1) Use dry air to prevent condensation when operating at low temperatures.

Note 2) Impact resistance: No malfunction occurred when it is tested with a drop tester in the axial direction and at the right angles to the main valve and armature in both energized and de-energized states every once for each condition. (Values at the initial period)

Vibration resistance: No malfunction occurred in a one-sweep test between 45 and 2000 Hz. Test was performed at both energized and de-energized states in the axial direction and at the right angles to the main valve and armature. (Values at the initial period)

Note 3) Available only with T, L, S and C.



How to Order Valves (Single Unit)

Body

0: Plug-in sub-plate

Sub-plate

Port size

Nil	Without sub-plate (For manifold)
02	1/4
03	3/8

Thread type

Nil	Rc
F	G
N	NPT
T	NPTF

Enclosure

Nil	Dust-protected
W	Dust-tight/Water-jet-proof (IP65)

CE-compliant

Nil	—
Q	CE-compliant

Note) CE-compliant: For DC only.

Porting specifications

Nil	Side ported
B	Bottom ported

Type of actuation

1	2-position single (A)(B)
2	2-position double (A)(B)
3	3-position closed center (A)(B)
4	3-position exhaust center (A)(B)
5	3-position pressure center (A)(B)
6	3-position double check (A)(B)

Note) For double check type, refer to page 478.

Manual override

Nil	Non-locking push type (Tool required)
B	Locking type (Tool required)
C	Locking type (Manual)

Light/Surge voltage suppressor

Nil	Yes
E	Without light, with surge voltage suppressor

Coil voltage

1	100 VAC (50/60 Hz)
2	200 VAC (50/60 Hz)
3	110 VAC (50/60 Hz)
4	220 VAC (50/60 Hz)
5	24 VDC
6	12 VDC

Electrical entry

G	Lead wire length 0.6 m
H	Lead wire length 1.5 m

Function

Nil	Standard (0.95 W)
Y	Low wattage type (0.4 W)
R	External pilot

Seal

0	Metal seal
1	Rubber seal

Coil voltage

1	100 VAC (50/60 Hz)
2	200 VAC (50/60 Hz)
3	110 VAC (50/60 Hz)
4	220 VAC (50/60 Hz)
5	24 VDC
6	12 VDC

Electrical entry

G	Lead wire length 0.6 m
H	Lead wire length 1.5 m

Body

5: Plug lead sub-plate

Sub-plate

CE-compliant

Nil	—
Q	CE-compliant

Thread type

Nil	Rc
F	G
N	NPT
T	NPTF

SV
SYJ
SZ
VF
VP4
VQ 1/2
VQ 4/5
VQC 1/2
VQC 4/5
VQZ
SQ
VFS
VFR
VQ7

How to Order Sub-plates



VQ4000 - P - - - 02 - - -

Electrical entry

P	Plug-in conduit terminal
S	Plug lead

CE-compliant

Nil	—
Q	CE-compliant

Thread type

Nil	Rc
F	G
N	NPT
T	NPTF

Enclosure

Nil	Dust-protected
W	Dust-tight/Water-jet-proof

Note) Not required for plug lead type.

Port size

02	1/4
03	3/8

Note) For bottom ported, port size is 1/4 only.

Porting specifications

Nil	Side ported
B	Bottom ported

Replacement of pilot valve assembly (Voltage)

- Refer to pages 486 and 487 for pilot valve assembly part numbers.
- Refer to page 534 for replacement method.

VQ4000 Series

Dimensions: Plug-in Type

Conduit terminal

2-position single: VQ410⁰-□

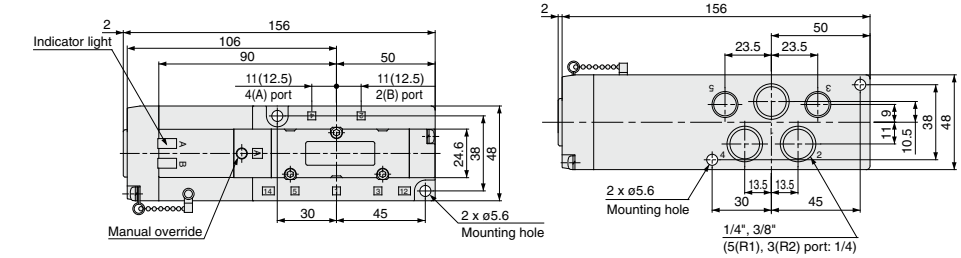

Bottom ported drawing

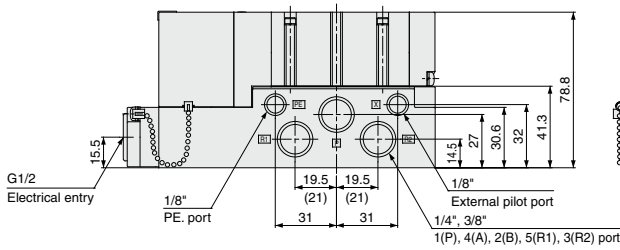

(): Values for 3/8"

- 2-position double: VQ420⁰-□
- 3-position closed center: VQ430⁰-□
- 3-position exhaust center: VQ440⁰-□
- 3-position pressure center: VQ450¹-□

3-position double check: VQ460⁰-□

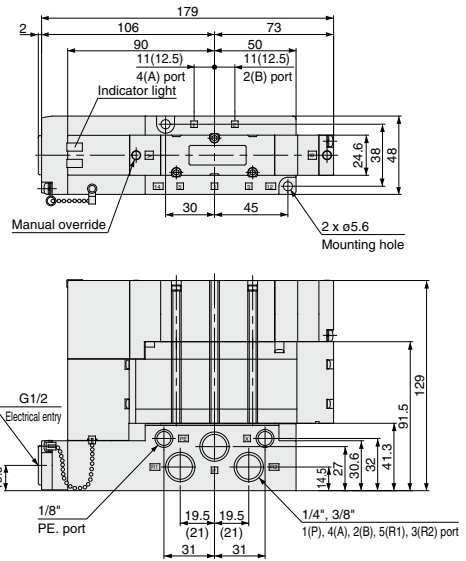
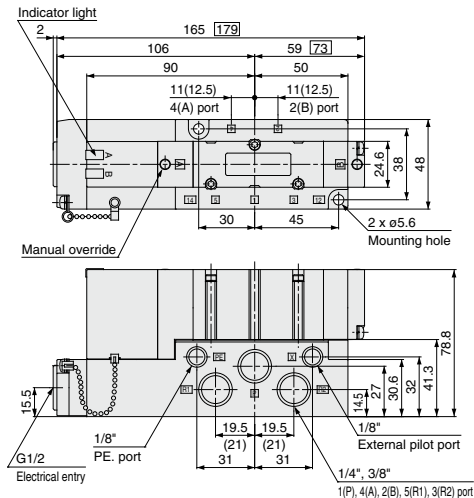

□: Values for 3-position
(): Values for 3/8"

Dimensions: Plug Lead Type

Grommet

2-position single: VQ415⁰-□_H

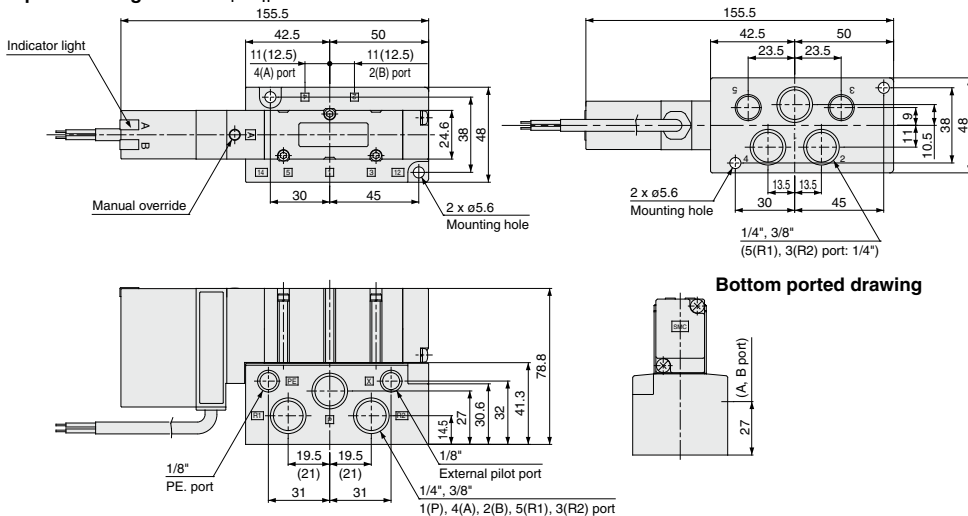

(): Values for 3/8"

2-position double: VQ425⁰-□_H

3-position closed center: VQ435⁰-□_H

3-position exhaust center: VQ445⁰-□_H

3-position pressure center: VQ455⁰-□_H

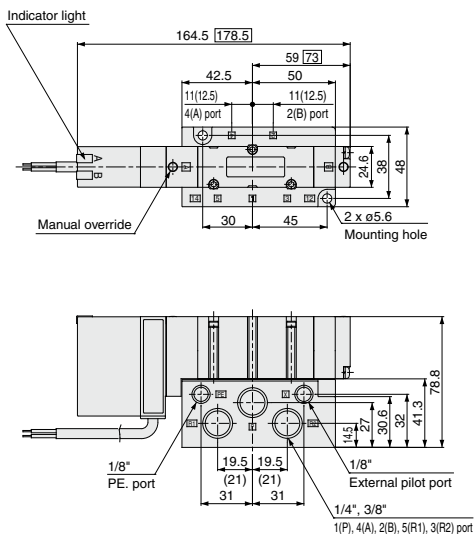

3-position double check: VQ465⁰-□_H

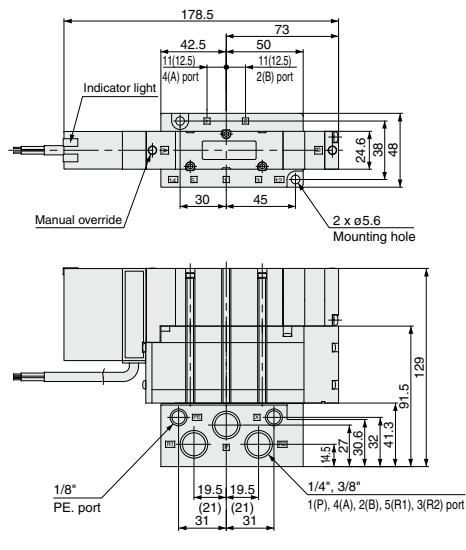

□ : Values for 3-position
 (): Values for 3/8"

SV
SYJ
SZ
VF
VP4
VQ 1/2
VQ 4/5
VQC 1/2
VQC 4/5
VQZ
SQ
VFS
VFR
VQ7

Base Mounted Plug-in Unit VQ4000 Series



[Option]
Note) CE-compliant:
For DC only.

How to Order Manifold

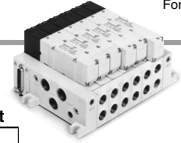

VV5Q 4 1 - 08 C8 [] F U1 [] - [] - []

Series

4	VQ4000
---	--------

Manifold

1	Plug-in unit
---	--------------

Stations

01	1 station
.	.
.	.
.	.

The maximum and minimum number of stations are varied depending on kit. (Refer to the table below.)

Cylinder port

C6	ø6 One-touch fitting
C8	ø8 One-touch fitting
C10	ø10 One-touch fitting
C12	ø12 One-touch fitting
O2	1/4
O3	3/8
B	Bottom ported 1/4
CM	Mixed
N7	ø1/4" One-touch fitting
N9	ø5/16" One-touch fitting
N11	ø3/8" One-touch fitting

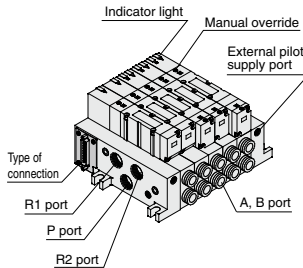

Note) Figure shows VV5Q41-05C12FD0.

Thread type

Nil	Rc
F	G
N	NPT
T	NPTF

Control unit
Refer to pages 482 to 485.

CE-compliant

Nil	—
Q	CE-compliant

Option

Symbol	Option
Nil	None
CD ^{Note 2)}	Exhaust cleaner: For D side mounting
CU ^{Note 2)}	Exhaust cleaner: For U side mounting
K ^{Note 3)}	Special wiring specifications (Except double wiring)
N	Name plate (T kit only)
SB	Direct exhaust with silencer box: Exhaust from both sides (F.L kills only)
SD ^{Note 2)}	Direct exhaust with silencer box: D side exhaust
SU ^{Note 2)}	Direct exhaust with silencer box: U side exhaust
W	Enclosure IP65 (Except F kit)

Note 1) When multiple symbols are specified, indicate them alphabetically.
Example) CDK
Note 2) Combination of [C] and [S] is not possible. Also, exhaust cleaner is not attached. Please order it separately.
Note 3) Specify the wiring specifications on the manifold specification sheet. (Except L kit)

Kit type

Kit type/Electrical entry/Cable length

F Kit (D-sub connector)

Connector entry direction		Cable length	1 to 18 stations
D side	U side		
Kit D0	Kit U0	Without cable	IP65 compatible
F D1	F U1	Cable length 1.5 m	
F D2	F U2	Cable length 3 m	
F D3	F U3	Cable length 5 m	

T Kit (Terminal block box kit)

Terminal block mounting position		IP65 compatible
D side	U side	
TD	T0	Terminal block box 3 to 18 stations ^{Note 1)}

L Kit (Lead wire cable)

Electrical entry		Cable length	1 to 16 stations
D side	U side		
Kit D0	Kit U0	Cable length 0.6 m	IP65 compatible
D1	U1	Cable length 1.5 m	
D2	U2	Cable length 3 m	

S Kit (Serial transmission unit)

The valve is equipped with a lamp/surge suppressor, and the voltage is 24 VDC.

IP65 compatible
* Applicable to INPUT and OUTPUT type.

Unit mounting position		3 to 18 stations ^{Note 1)}
D side	U side	
0	Without SI Unit	
H	NKE Corp.: Fieldbus H System	
Q	DeviceNet	
R1	OMRON Corp.: CompoBus S System (16 output points)	
R2	OMRON Corp.: CompoBus S System (8 output points)	
V	CC-Link	

Note 1) For the T kit and S kit, 2 stations are required to mount the terminal block box or SI Unit, so the minimum number of stations is 3 stations.
Note 2) Refer to "SI Unit Part No." on page 468 when ordering the CE-compliant SI Unit.

Simple specials are available with SMC Simple Special System. Please contact your local sales representative for more details.

Manifold Specifications

Series	Base model	Type of connection	Porting specifications			Maximum applicable stations	Applicable valve	Weight [kg] (Formula)
			4(A), 2(B) port location	Port size				
				1(P), 5(R1), 3(R2)	4(A), 2(B)			
VQ4000	VV5Q41-□□□	<ul style="list-style-type: none"> ■ F kit—D-sub connector ■ T kit—Terminal block box ■ L kit—Lead wire ■ S kit—Serial transmission 	Side	1/2 Option (Direct exhaust with silencer box)	C6 (For ø6) C8 (For ø8) C10 (For ø10) C12 (For ø12) 1/4 3/8 N7 (For ø1/4") N9 (For ø5/16") N11 (For ø3/8")	F, T kit 18 stations L kit 16 stations S kit 18 stations	VQ4□00 VQ4□01	F, L kit: 0.32n + 0.75 S, T kit: 0.32(n-2) + 1.8 • Not including valve weight.
			Bottom		1/4			

n: Stations

Flow Rate Characteristics at the Number of Manifold Stations (Operated individually)

Model	Passage/Stations	Station 1	Station 5	Station 10	Station 15	
2-position metal seal VQ4 ² 00	1 → 4/2 (P → A/B)	C [dm ³ /(s·bar)]	5.9	5.9	5.9	5.9
		b	0.23	0.23	0.23	0.23
		Cv	1.5	1.5	1.5	1.5
	4/2 → 5/3 (A/B → EA/EB)	C [dm ³ /(s·bar)]	6.2	6.2	6.2	6.2
		b	0.19	0.19	0.19	0.19
		Cv	1.5	1.5	1.5	1.5
2-position rubber seal VQ4 ² 01	1 → 4/2 (P → A/B)	C [dm ³ /(s·bar)]	6.8	6.8	6.8	6.8
		b	0.31	0.31	0.31	0.31
		Cv	1.8	1.8	1.8	1.8
	4/2 → 5/3 (A/B → EA/EB)	C [dm ³ /(s·bar)]	7.0	7.0	7.0	7.0
		b	0.38	0.38	0.38	0.38
		Cv	1.9	1.9	1.9	1.9

Note) Port size: 3/8

Manifold Options

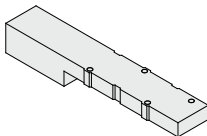
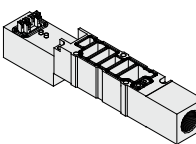
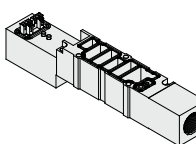
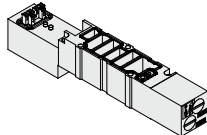
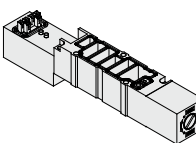
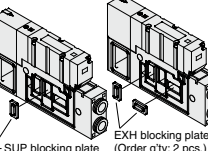
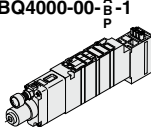
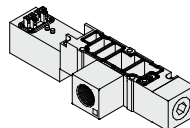
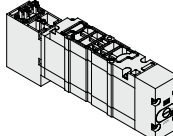
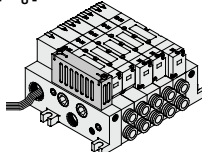
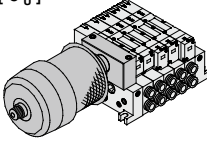
<p>Blanking plate assembly VVQ4000-10A-1</p> 	<p>Individual SUP spacer VVQ4000-P-1⁰²₀₃</p> 	<p>Individual EXH spacer VVQ4000-R-1⁰²₀₃</p> 	<ul style="list-style-type: none"> • Refer to pages 476 to 480 for detailed dimensions of each option. • For replacement parts, refer to page 489. • Refer to pages 482 to 485 for control unit.
<p>Restrictor spacer VVQ4000-20A-1</p> 	<p>SUP stop valve spacer VVQ4000-37A-1</p> 	<p>SUP/EXH block plate VVQ4000-16A (1 pc./set)</p>  <p>EXH blocking plate (Order qty: 2 pcs.) SUP blocking plate</p>	<p>Interface regulator (P, A, B port regulation) ARBQ4000-00-^A_{B-1}_P</p> 
<p>Release valve spacer: For D side mounting VVQ4000-24A-1D ^{Note 1)} ₂₎</p> 	<p>Double check spacer with residual pressure exhaust VVQ4000-25A-1 ^{Note 1)}</p> 	<p>Direct exhaust with silencer box [-S^D_U]</p> 	<p>Manifold mounted exhaust cleaner [-C^D_U]</p> 

Note 1) Release valve spacer and double check spacer with residual pressure exhaust cannot be combined with external pilot.

Note 2) Can be mounted on L kit only. For other kits, order E type control unit.

(Refer to pages 482 to 485.)

SV
SYJ
SZ
VF
VP4
VQ 1/2
VQ 4/5
VQC 1/2
VQC 4/5
VQZ
SQ
VFS
VFR
VQ7

VQ4000 Series

F Kit (D-sub connector kit)

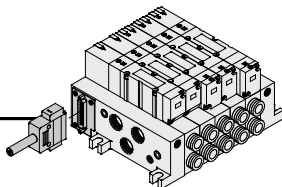

- Simplification and labor savings for wiring work can be achieved by using a D-sub connector for the electrical connection.
- Using connector for flat ribbon cable (25P) conforming to MIL standard permits the use of connectors put on the market and gives a wide interchangeability.
- Connector entry can be selected on either the U side or the D side according to the mounting orientation.
- Maximum stations are 18.

Manifold Specifications

Series	Porting specifications			Applicable stations
	4(A), 2(B) port location	Port size		
VQ4000	Side	1(F), 5(R1), 3(R2)	4(A), 2(B)	Max. 18 stations
	Bottom	1/2	C6, C8, C10, C12, 1/4, 3/8, N7, N9, N11	

D-Sub Connector Kit (25 pins)

Cable assembly ●

015
AXT100-DS25-030
050

(D-sub connector cable assemblies can be ordered by with manifolds.)
(Refer to How to Order Manifold.)

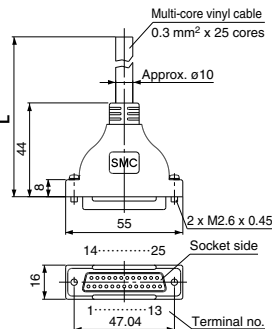

D-sub Connector Cable Assembly

Cable length [L]	Assembly part no.	Note
1.5 m	AXT100-DS25-015	Cable 0.3 mm ²
3 m	AXT100-DS25-030	x 25 cores
5 m	AXT100-DS25-050	

- * For other commercial connectors, use a 25-pin type female connector conforming to MIL-C-24308.
- * Cannot be used for transfer wiring.

Connector Manufacturers Example

- Fujitsu, Limited
- Japan Aviation Electronics Industry, Limited
- J.S.T. Mfg. Co., Ltd.
- HIROSE ELECTRIC CO., LTD.

Electric Characteristics

Item	Characteristics
Conductor resistance	65 or less Ω/km, 20°C
Voltage limit	1000 VAC, 1 min.
Insulation resistance	5 or more MΩkm, 20°C

Note) The minimum bending radius for D-sub connector cables is 20 mm.

D-sub Connector Cable Assembly Terminal No.

Terminal no.	Lead wire color	Dot marking
1	Black	None
2	Brown	None
3	Red	None
4	Orange	None
5	Yellow	None
6	Pink	None
7	Blue	None
8	Purple	White
9	Gray	Black
10	White	Black
11	White	Red
12	Yellow	Red
13	Orange	Red
14	Yellow	Black
15	Pink	Black
16	Blue	White
17	Purple	None
18	Gray	None
19	Orange	Black
20	Red	White
21	Brown	White
22	Pink	Red
23	Gray	Red
24	Black	White
25	White	None

Note) Lengths other than the above are also available. Please contact SMC for details.

How to Order Manifold

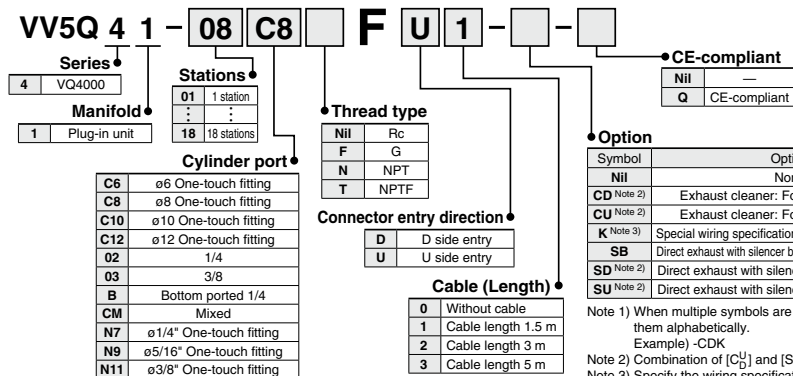

Note) As a semi-standard specification, the maximum number of stations can be increased by special wiring specifications. For details, refer to page 457.

● Electrical wiring specifications

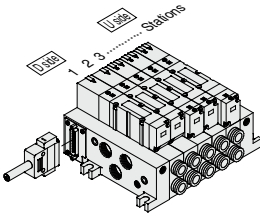

Stations are counted starting from the first station on the D side.

D-sub connector

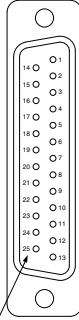

Double wiring (connected to SOL.A and SOL.B) is adopted for the internal wiring of each station, regardless of valve and option types. Mixed single and double wiring is available as a semi-standard specification. For details, refer to below.

Note) There is no polarity. It can also be used as a negative common.

Standard wiring Wiring with control unit

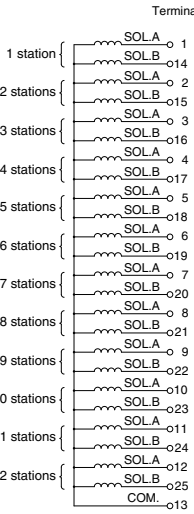

Terminal no.	Terminal no.	Polarity	Lead wire color	Dot marking
SOL.A 1	Release valve 1 (-)	(+)	Black	None
SOL.B -14	Pressure switch 1 (+)	(-)	Yellow	Black
SOL.A 2	2 (-)	(+)	Brown	None
SOL.B -15	15 (+)	(-)	Pink	Black
SOL.A 3	SOL.A 3 (-)	(+)	Red	None
SOL.B -16	SOL.A -16 (-)	(+)	Blue	White
SOL.A 4	SOL.A 4 (-)	(+)	Orange	None
SOL.B -17	SOL.B -17 (-)	(+)	Purple	None
SOL.A 5	SOL.A 5 (-)	(+)	Yellow	None
SOL.B -18	SOL.B -18 (-)	(+)	Gray	None
SOL.A 6	SOL.A 6 (-)	(+)	Pink	None
SOL.B -19	SOL.B -19 (-)	(+)	Orange	Black
SOL.A 7	SOL.A 7 (-)	(+)	Blue	None
SOL.B -20	SOL.A -20 (-)	(+)	Red	White
SOL.A 8	SOL.A 8 (-)	(+)	Purple	White
SOL.B -21	SOL.A -21 (-)	(+)	Brown	White
SOL.A 9	SOL.A 9 (-)	(+)	Gray	Black
SOL.B -22	SOL.B -22 (-)	(+)	Pink	Red
SOL.A 10	SOL.A 10 (-)	(+)	White	Black
SOL.B -23	SOL.B -23 (-)	(+)	Gray	Red
SOL.A 11	SOL.A 11 (-)	(+)	White	Red
SOL.B -24	SOL.B -24 (-)	(+)	Black	White
SOL.A 12	SOL.A 12 (-)	(+)	Yellow	Red
SOL.B -25	SOL.B -25 (-)	(+)	White	None
COM. -13	-13 (+)	(-) ^{Note)}	Orange	Red

Positive common specifications Negative common specifications

D-sub connector assembly
AXT100-DS25-030 015 050
Wire colors

- SV
- SYJ
- SZ
- VF
- VP4
- VQ 1/2
- VQ 4/5
- VQC 1/2
- VQC 4/5
- VQZ
- SQ
- VFS
- VFR
- VQ7

Special Wiring Specifications

Double wiring (connected to SOL.A and SOL.B) is used for the internal wiring of each station regardless of valve and option types. Mixed single and double wiring is available as a semi-standard specification.

1. How to Order

Indicate option symbol "K" in the manifold part number and be sure to specify station positions for single or double wiring on the manifold specification sheet.

2. Wiring specifications

Connections begin with the A side solenoid of the first station being connected to terminal no. 1, and continue in the order indicated by the arrows in the drawing without skipping any terminals. Maximum stations are 18.

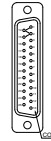

D-sub connector

How to Order Valves

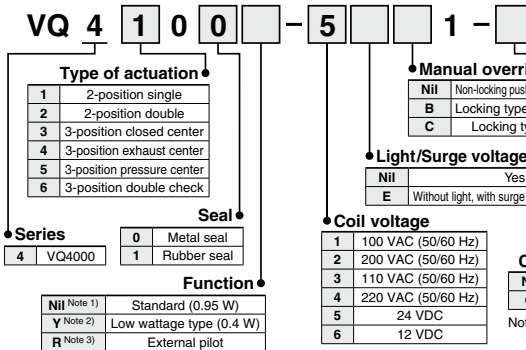

Note 1) When the unit is energized continuously, refer to "Specific Product Precautions 1" on page 533.
 Note 2) In addition, only DC is available with Y.
 Note 3) For external pilot specifications, refer to page 481. Combination of external pilot and perfect interface is not possible.
 Note 4) When multiple symbols are specified, indicate them alphabetically.

How to Order Manifold Assembly

Specify the part numbers for valves and options together beneath the manifold base part number.

<Example>
 D-sub connector kit with cable (3 m)
 VV5Q41-05C8FD2(-Q)-1 set—Manifold base part no.
 *VQ4100-51(-Q).....2 sets—Valve part no. (Stations 1 and 2)
 *VQ4200-51(-Q).....2 sets—Valve part no. (Stations 3 and 4)
 *VQ4300-51(-Q).....1 set—Valve part no. (Station 5)

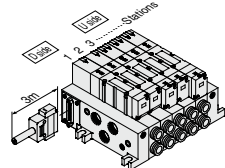
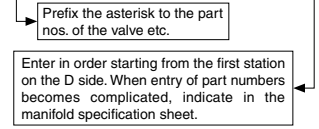

VQ4000 Series

F Kit (D-sub connector kit)

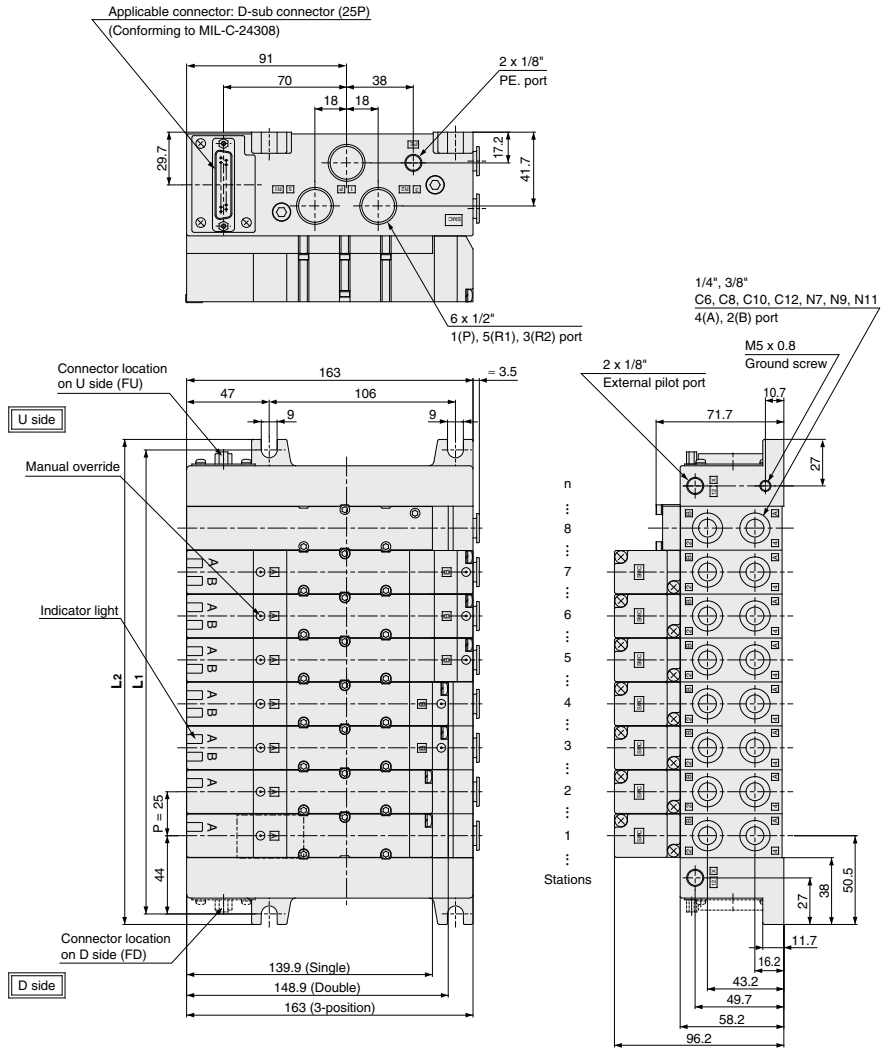

Bottom ported drawing

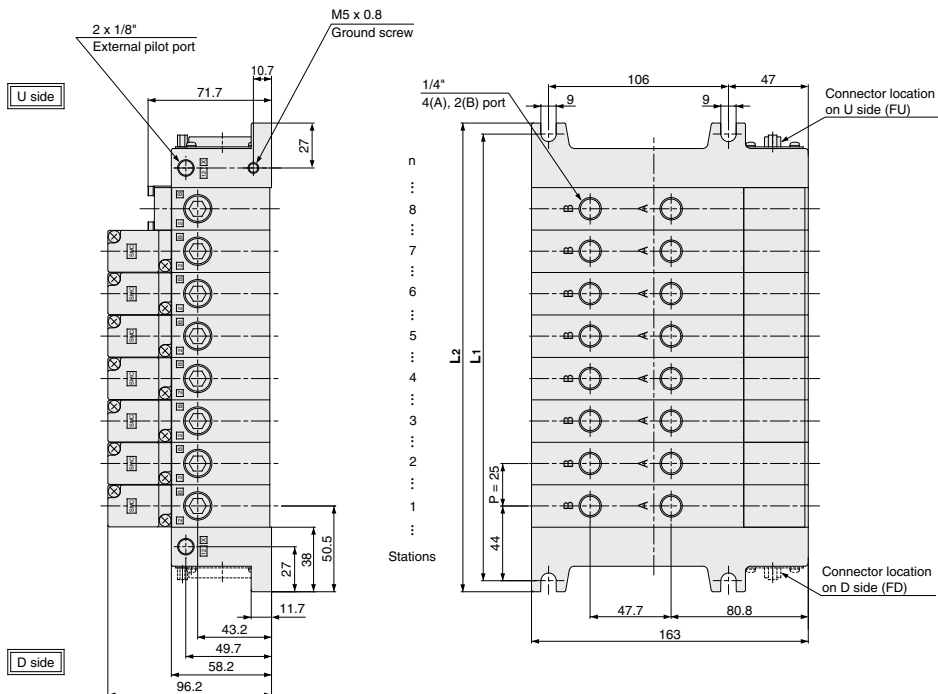

SV
SYJ
SZ
VF
VP4
VQ 1/2
VQ 4/5
VQC 1/2
VQC 4/5
VQZ
SQ
VFS
VFR
VQ7

Dimensions

Formula: $L_1 = 25n + 63$, $L_2 = 25n + 76$ n: Stations (Maximum standard 18 stations)

L	n	1	2	3	4	5	6	7	8	9	10	11	12	13	14	15	16	17	18
L ₁		88	113	138	163	188	213	238	263	288	313	338	363	388	413	438	463	488	513
L ₂		101	126	151	176	201	226	251	276	301	326	351	376	401	426	451	476	501	526

VQ4000 Series

T Kit (Terminal block box kit)

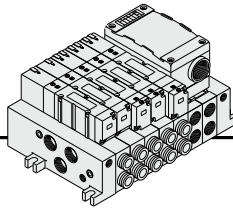

IP65 compliant

- Enclosure IP65 compliant
- This type has a small terminal block inside a junction box. The provision of a G3/4 electrical entry allows connection of conduit fittings.
- Maximum stations are 18.
- 2 stations are used for terminal box mounting.

Manifold Specifications

Series	4(A), 2(B) port location	Porting specifications		Applicable stations
		1(P), 5(R1), 3(R2)	Port size	
VQ4000	Side	1/2	4(A), 2(B) C6, C8, C10, C12, 1/4, 3/8, N7, N9, N11	Max. 18 stations
	Bottom		1/4	

Terminal Block Connections

Step 1. How to remove terminal block cover

Loosen the 4 mounting screws (M4) and open the terminal block cover.

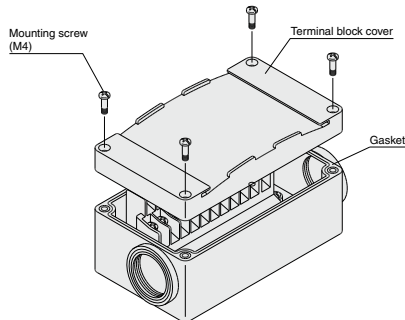

Step 2. The diagram on the right shows the terminal block wiring. All stations are provided with double wiring regardless of the valves which are mounted.

Connect each wire to the power supply side, according to the markings provided inside the terminal block.

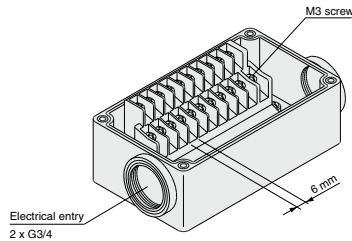

Step 3. How to attach the terminal block cover

Securely tighten the screws with the torque shown in the table below, after confirming that the gasket is installed correctly.

Proper tightening torque [N·m]
0.7 to 1.2

- Applicable terminal: 1.25-3S, 1.25Y-3, 1.25Y-3N, 1.25Y-3.5
- Name plate: VVQ5000-N-T
- Drip proof plug assembly (for G3/4): AXT100-B06A

How to Order Manifold

VV5Q 4 1 - 08 C8 T 0 - -

Series
4 VQ4000

Manifold
1 Plug-in unit

Stations
03 3 stations
18 18 stations

Cylinder port

C6	ø6 One-touch fitting
C8	ø8 One-touch fitting
C10	ø10 One-touch fitting
C12	ø12 One-touch fitting
02	1/4
03	3/8
B	Bottom ported 1/4
CM	Mixed
N7	ø1/4" One-touch fitting
N9	ø5/16" One-touch fitting
N11	ø3/8" One-touch fitting

Box mounting position
0 U side mounting
D D side mounting

Thread type

Nil	Rc
F	G
N	NPT
T	NPTF

CE-compliant

Nil	—
Q	CE-compliant

Option

Symbol	Option
Nil	None
CD (Note 2)	Exhaust cleaner: D side exhaust
CU (Note 2)	Exhaust cleaner: U side exhaust
K (Note 3)	Special wiring specifications (Except double wiring, 13 stations or more)
N (Note 4)	Name plate
SD (Note 2)	Direct exhaust with silencer box: D side exhaust
SU (Note 2)	Direct exhaust with silencer box: U side exhaust
W	IP65 enclosure

Note) 2 stations are used for mounting the terminal block box. The number of stations is the number of manifold valves plus 2 stations for the terminal block box. For 13 stations or more, specify the wiring specifications by means of the manifold specification sheet.

Note) As a semi-standard specification, the maximum number of stations can be increased by special wiring specifications. For details, refer to page 461.

Note 1) When multiple symbols are specified, indicate them alphabetically.
Example) -CDK

Note 2) Combination of [CD] and [SD] is not possible.

Note 3) Specify the wiring specifications on the manifold specification sheet.

Note 4) Name plate is inlaid in the terminal block cover.

Note 5) Refer to pages 482 to 485 for with control unit.



● Electrical wiring specifications

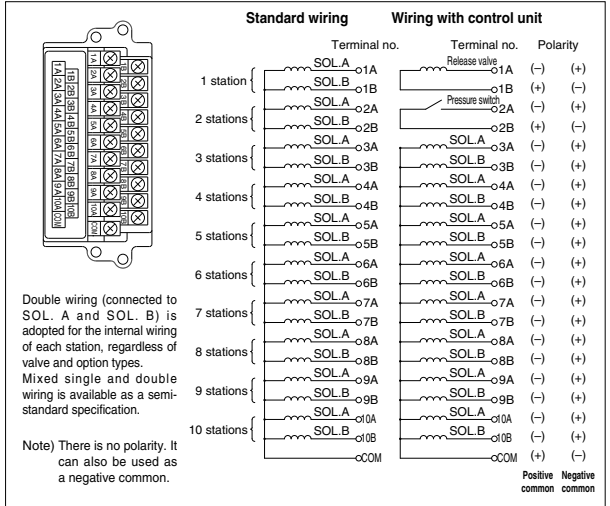
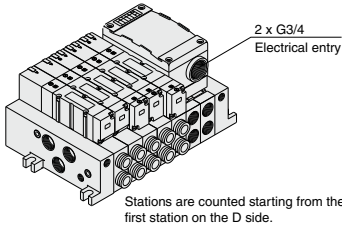

- SV
- SYJ
- SZ
- VF
- VP4
- VQ 1/2
- VQ 4/5
- VQC 1/2
- VQC 4/5
- VQZ
- SQ
- VFS
- VFR
- VQ7

Special Wiring Specifications

Double wiring (connected to SOL. A and SOL. B) is used for the internal wiring of each station regardless of valve and option types. Mixed single and double wiring is available as a semi-standard specification. However, the maximum number of stations is 16.

1. How to Order

Indicate option symbol "K" in the manifold part number and be sure to specify station positions for single or double wiring on the manifold specification sheet.

2. Wiring specifications

Connections begin with the A side solenoid of the first station being connected to terminal no. 1, and continue in the order indicated by the arrows in the drawing without skipping any terminals.

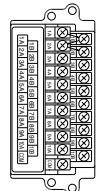

How to Order Valves

How to Order Manifold Assembly

Specify the part numbers for valves and options together beneath the manifold base part number.

<Example>

Terminal block box kit
 VV5Q41-07C8T0(-Q)-1 set—Manifold base part no.
 *VQ4100-51(-Q).....2 sets—Valve part no. (Stations 1 and 2)
 *VQ4200-51(-Q).....2 sets—Valve part no. (Stations 3 and 4)
 *VQ4300-51(-Q).....1 set—Valve part no. (Station 5)

Prefix the asterisk to the part nos. of the valve etc.

Enter in order starting from the first station on the D side. When entry of part numbers becomes complicated, indicate in the manifold specification sheet.

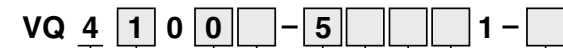
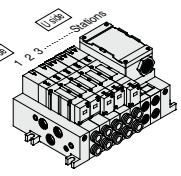

Type of actuation

1	2-position single
2	2-position double
3	3-position closed center
4	3-position exhaust center
5	3-position pressure center
6	3-position double check

Seal

0	Metal seal
1	Rubber seal

Series

4	VQ4000
---	--------

Function

Nil	Note 1) Standard (0.95 W)
Y	Note 2) Low wattage type (0.4 W)
R	Note 3) External pilot

CE-compliant

Nil	—
Q	CE-compliant

Note) CE-compliant: For DC only.

Enclosure

Nil	Dust-protected
W	Dust-tight/ Water-jet-proof (IP65)

Manual override

Nil	Non-locking push type (Tool required)
B	Locking type (Tool required)
C	Locking type (Manual)

Light/Surge voltage suppressor

Nil	Yes
E	Without light, with surge voltage suppressor

Coil voltage

1	100 VAC (50/60 Hz)
2	200 VAC (50/60 Hz)
3	110 VAC (50/60 Hz)
4	220 VAC (50/60 Hz)
5	24 VDC
6	12 VDC

Note 1) When the unit is energized continuously, refer to "Specific Product Precautions 1" on page 533.
 Note 2) In addition, only DC. is available with Y.
 Note 3) For external pilot specifications, refer to page 481. Combination of external pilot and perfect interface is not possible.
 Note 4) When multiple symbols are specified, indicate them alphabetically.

VQ4000 Series



Kit (Terminal block box kit)

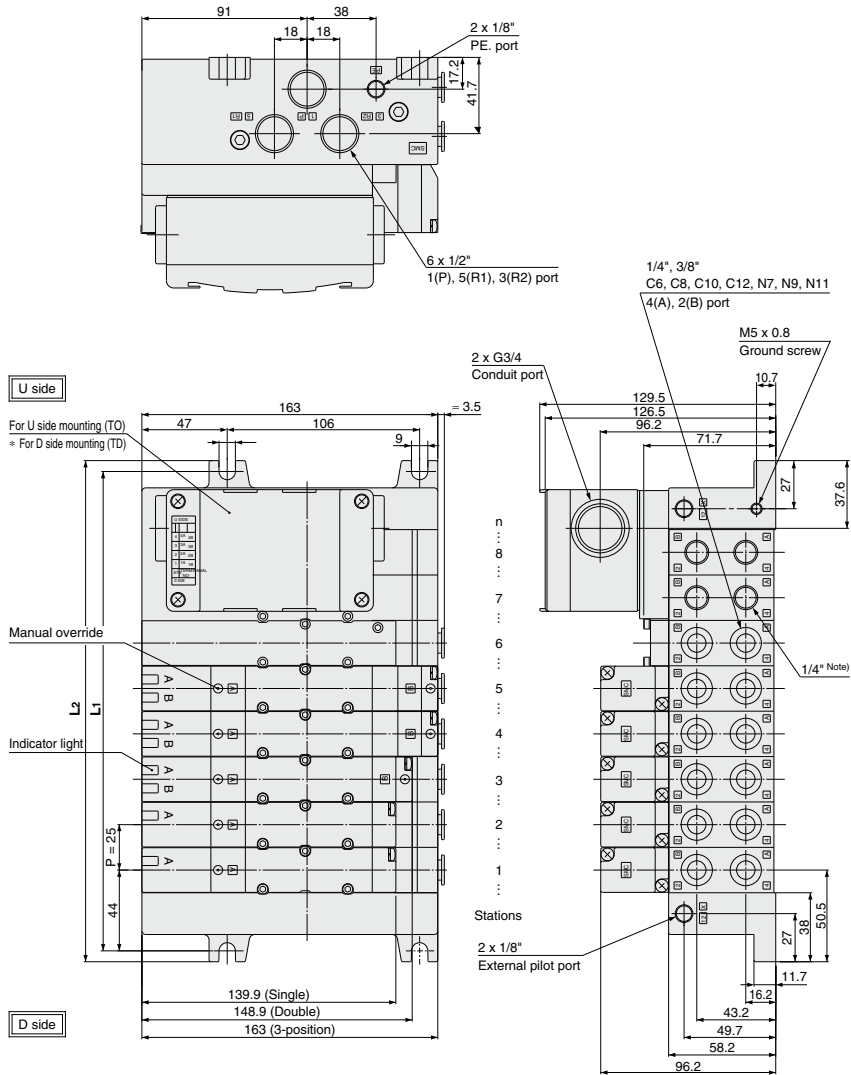

Shown VV5Q41-08C12TO-W.
 Note) 4(A) and 2(B) port at the bottom of the terminal block box are 1/4".

Bottom ported drawing

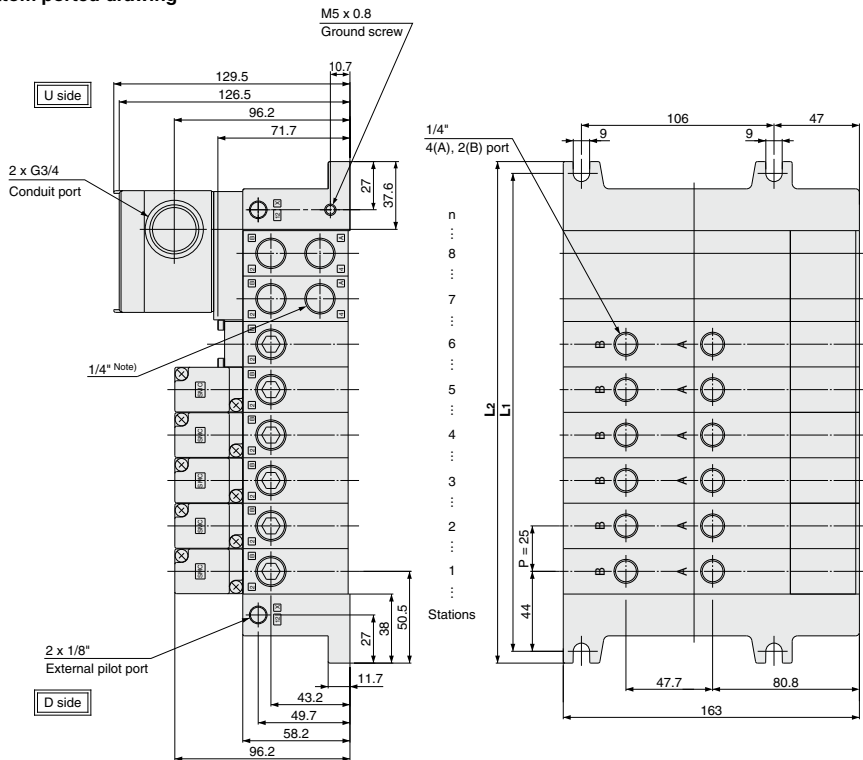

Note) 4(A) and 2(B) port at the bottom of the terminal block box are 1/4\".

- SV
- SYJ
- SZ
- VF
- VP4
- VQ 1/2
- VQ 4/5**
- VQC 1/2
- VQC 4/5
- VQZ
- SQ
- VFS
- VFR
- VQ7

Dimensions

Formula: $L_1 = 25n + 63$, $L_2 = 25n + 76$ n: Stations (Maximum standard 18 stations)
* Including 2 stations for mounting terminal box.

n	3	4	5	6	7	8	9	10	11	12	13	14	15	16	17	18
L ₁	138	163	188	213	238	263	288	313	338	363	388	413	438	463	488	513
L ₂	151	176	201	226	251	276	301	326	351	376	401	426	451	476	501	526

VQ4000 Series

L Kit (Lead wire cable)

IP65 compliant

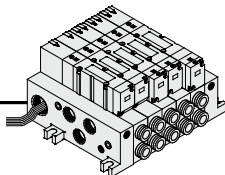

- Enclosure IP65 compliant
- Direct electrical entry. Models with two or more stations are available.
- Electrical entry can be selected on either the U side or the D side according to the mounting orientation.
- Maximum stations are 16.

Manifold Specifications

Series	4(A), 2(B) port location	Porting specifications		Applicable stations
		1(P), 5(R1), 3(R2)	4(A), 2(B)	
VQ4000	Side	1/2	C6 (for ø6), C8 (for ø8), C10 (for ø10), C12 (for ø12), 1/4, 3/8, N7 (for ø1/4), N9 (for ø5/16"), N11 (for ø3/8")	Max. 16 stations
	Bottom		1/4	

Wiring Specifications

Three lead wires are attached to each station regardless of the type of valve which is mounted. The red wire is for COM connection.

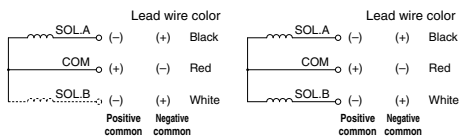

Single solenoid

Double solenoid

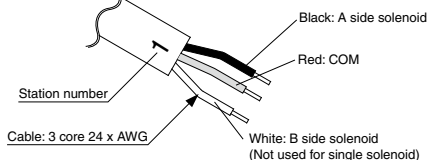

Cable: 3 core 24 x AWG

Lead Wire Assembly with Connector

Lead wire length	Part no.
0.6 m	VVQ5000-44A-8-□
1.5 m	VVQ5000-44A-15-□
3 m	VVQ5000-44A-30-□

□: Number of stations 1 to 16.

For different lead wire lengths, order a lead wire assembly with connector shown in the table on the right.
Note 1) There is no polarity. It can also be used as a negative common.
Note 2) Connect the release valve and the pressure switch to SOL. A side on the manifold with control unit.

How to Order Manifold

CE
[Option]

VV5Q 4 1 - 08 C8 [] L U [] - [] - []

Series
4 VQ4000

Manifold
1 Plug-in unit

Stations

01	1 station
...	...
16	16 stations

Cylinder port

C6	ø6 One-touch fitting
C8	ø8 One-touch fitting
C10	ø10 One-touch fitting
C12	ø12 One-touch fitting
02	1/4
03	3/8
B	Bottom ported 1/4
CM	Mixed
N7	ø1/4" One-touch fitting
N9	ø5/16" One-touch fitting
N11	ø3/8" One-touch fitting

Connector locations

D	D side entry
U	U side entry

Cable (Length)

0	Cable length 0.6 m
1	Cable length 1.5 m
2	Cable length 3 m

Thread type

Nil	Rc
F	G
N	NPT
T	NPTF

CE-compliant

Nil	—
Q	CE-compliant

Option

Symbol	Option
Nil	None
CD	Exhaust cleaner: For D side mounting
CU	Exhaust cleaner: For U side mounting
SB	Direct exhaust with silencer box: Exhaust from both sides
SD	Direct exhaust with silencer box: D side exhaust
SU	Direct exhaust with silencer box: U side exhaust
W	IP65 enclosure

Note 1) When multiple symbols are specified, indicate them alphabetically.

Example) -CDW

Note 2) Combination of [C₆] and [S₆] is not possible.

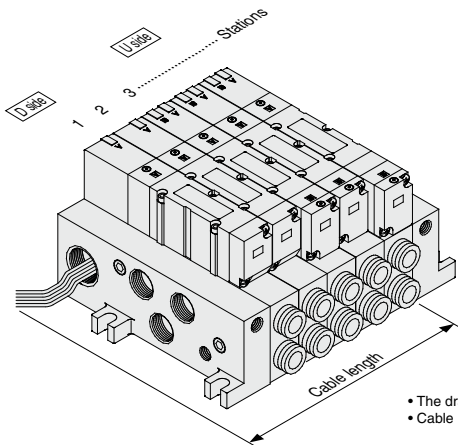

- The drawing shows the electrical entry on the D side.
- Cable length is measured from the valve body.



How to Order Valves

How to Order Manifold Assembly

VQ 4 1 0 0 - 5 - - - 1 -

Specify the part numbers for valves and options together beneath the manifold base part number.

<Example>

Lead wire kit with cable (3 m)

VV5Q41-05C8LD2(-Q)-1 set—Manifold base part no.

*VQ4100-51(-Q).....2 sets—Valve part no. (Stations 1 and 2)

*VQ4200-51(-Q).....2 sets—Valve part no. (Stations 3 and 4)

*VQ4300-51(-Q).....1 set—Valve part no. (Station 5)

Prefix the asterisk to the part nos. of the valve etc.

Enter in order starting from the first station on the D side. When entry of part numbers becomes complicated, indicate in the manifold specification sheet.

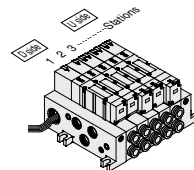

Series

4	VQ4000
---	--------

Type of actuation

1	2-position single
2	2-position double
3	3-position closed center
4	3-position exhaust center
5	3-position pressure center
6	3-position double check

Seal

0	Metal seal
1	Rubber seal

Function

Nil (Note 1)	Standard (0.95 W)
Y (Note 2)	Low wattage type (0.4 W)
R (Note 3)	External pilot

Note 1) When the unit is energized continuously, refer to "Specific Product Precautions 1" on page 533.

Note 2) In addition, only DC is available with Y.

Note 3) For external pilot specifications, refer to page 481.

Combination of external pilot and perfect interface is not possible.

Note 4) When multiple symbols are specified, indicate them alphabetically.

CE-compliant

Nil	—
Q	CE-compliant

Note) CE-compliant: For DC only.

Enclosure

Nil	Dust-protected
W	Dust-tight/ Water-jet-proof (IP65)

Manual override

Nil	Non-locking push type (Tool required)
B	Locking type (Tool required)
C	Locking type (Manual)

Light/Surge voltage suppressor

Nil	Yes
E	Without light, with surge voltage suppressor

Coil voltage

1	100 VAC (50/60 Hz)
2	200 VAC (50/60 Hz)
3	110 VAC (50/60 Hz)
4	220 VAC (50/60 Hz)
5	24 VDC
6	12 VDC

VQ4000 Series

L Kit (Lead wire cable)

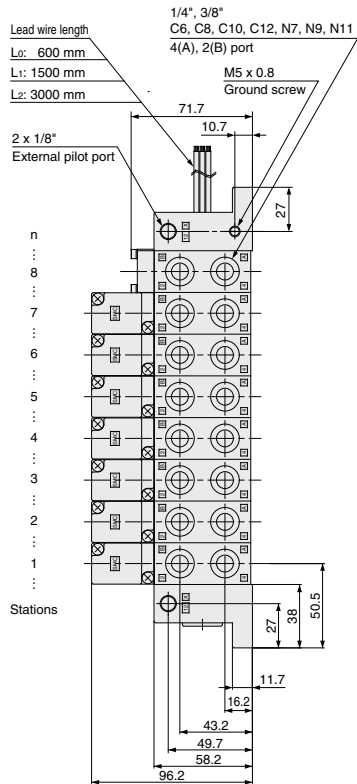
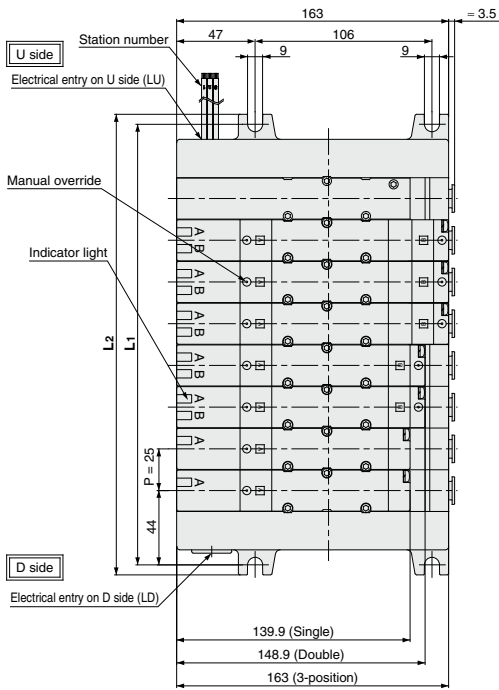
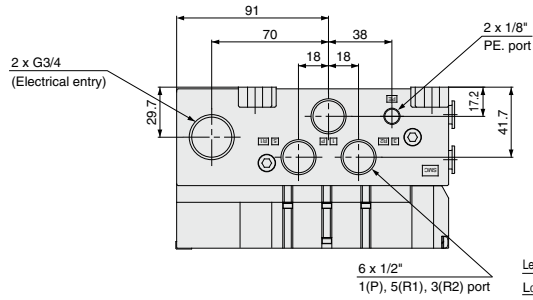

Bottom ported drawing

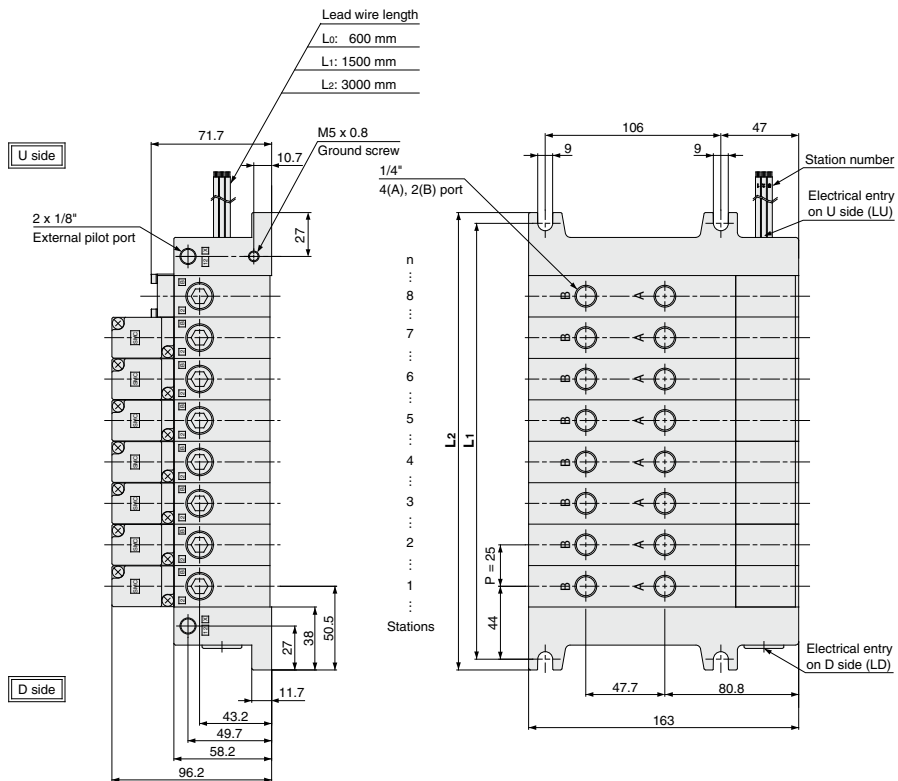

- SV
- SYJ
- SZ
- VF
- VP4
- VQ 1/2
- VQ 4/5
- VQC 1/2
- VQC 4/5
- VQZ
- SQ
- VFS
- VFR
- VQ7

Dimensions

Formula: $L_1 = 25n + 63$, $L_2 = 25n + 76$ n: Stations (Maximum 16 stations)

L \ n	1	2	3	4	5	6	7	8	9	10	11	12	13	14	15	16
L1	88	113	138	163	188	213	238	263	288	313	338	363	388	413	438	463
L2	101	126	151	176	201	226	251	276	301	326	351	376	401	426	451	476

VQ4000 Series

S Kit (Serial transmission unit): EX123/124 (For Output) Serial Transmission System **IP65 compliant**

• The serial transmission system reduces wiring work, while minimizing wiring and saving space.

• Double wiring (connected to SOL. A and SOL. B) is adopted for the internal wiring of each station, regardless of valve and option types. Mixed single and double wiring is available as a semi-standard specification.

Manifold Specifications

Series	Porting specifications	Port size		Applicable stations
		4(A), 2(B) port location	1(P), 5(R1), 3(R2)	
VQ4000	Side	1/2	C6 (for ø6), C8 (for ø8), C10 (for ø10), C12 (for ø12), 1/4, 3/8, N7 (for ø1/4"), N9 (for ø5/16"), N11 (for ø3/8")	Max. 18 stations
	Bottom		1/4	

Item	Specifications
External power supply	24 VDC +10%, -5%
Current consumption (Internal unit)	0.1 A

• Drip proof plug assembly (for G1/2): AXT100-B04A

Note) Refer to "SI Unit Part No." when ordering the CE-compliant SI Unit. **[Option]**



How to Order Manifold

VV5Q 4 1 - 08 C8 S V - -

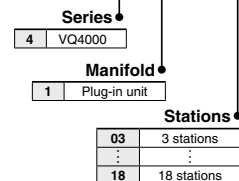

Note) 2 stations are used for mounting SI Unit. The number of stations is the number of manifold valves plus 2 stations for SI Unit. For 11 stations or more, specify the wiring specifications by means of the manifold specification sheet.

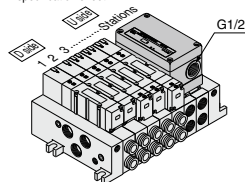

Stations are counted starting from the first station on the D side.

Cylinder port

C6	ø6 One-touch fitting
C8	ø8 One-touch fitting
C10	ø10 One-touch fitting
C12	ø12 One-touch fitting
02	1/4
03	3/8
B	Bottom ported 1/4
CM	Mixed
N7	ø1/4" One-touch fitting
N9	ø5/16" One-touch fitting
N11	ø3/8" One-touch fitting

Thread type

Nil	Rc
F	G
N	NPT
T	NPTF

SI Unit mounting position

Nil	U side mounting
D	D side mounting

• CE-compliant

Nil	—
Q	CE-compliant

Note) Refer to "SI Unit Part No." when ordering the CE-compliant SI Unit.

Option

Symbol	Option
Nil	None
CD	Exhaust cleaner: D side exhaust
CU	Exhaust cleaner 1: U side exhaust
K	Special wiring specifications (Except double wiring, 11 stations or more)
SD	Direct exhaust with silencer box: D side exhaust
SU	Direct exhaust with silencer box: U side exhaust
W	IP65 enclosure

Note 1) When multiple symbols are specified, indicate them alphabetically. Example) -CDK

Note 2) Combination of [CD] and [SD] is not possible.

Note 3) Specify the wiring specifications in the manifold specification sheet.

Note 4) Refer to pages 482 to 485 for with control unit.

Note 5) The release valve and the pressure switch on the manifold with control unit are connected to another power supply. Cable length is 0.6 m for L kit.

SI Unit

0	Without SI Unit
H	NKE Corp.: Fieldbus H System (16 output points)
Q	DeviceNet™ (16 output points)
R1	OMRON Corp.: CompoBus/S System (16 output points)
R2	OMRON Corp.: CompoBus/S System (8 output points)
V	CC-Link (16 output points)

SI Unit Part No.

Symbol	Protocol type	SI Unit part no.	CE-compliant	Page
H	NKE Corp.: Fieldbus H System (16 output points)	D side: EX123D-SUH1 U side: EX123U-SUH1	—	489
Q	DeviceNet™ (16 output points)	D side: EX124D-SDN1 U side: EX124U-SDN1	●	
R1	OMRON Corp.: CompoBus/S System (16 output points)	D side: EX124D-SCS1 U side: EX124U-SCS1	●	
R2	OMRON Corp.: CompoBus/S System (8 output points)	D side: EX124D-SCS2 U side: EX124U-SCS2	●	
V	CC-Link (16 output points)	D side: EX124D-SMJ1 U side: EX124U-SMJ1	●	

Refer to Best Pneumatics No. 1-1 and the Operation Manual for the details of EX123/124 Integrated-type (For Output) Serial Transmission System. Please download the Operation Manual via SMC website, <http://www.smccworld.com>



How to Order Valves

How to Order Manifold Assembly

Specify the part numbers for valves and options together beneath the manifold base part number.

<Example>

- VV5Q41-07C8SV(-Q)-...1 set—Manifold base part no.
- *VQ4100-51(-Q).....2 sets—Valve part no. (Stations 1 and 2)
- *VQ4200-51(-Q).....2 sets—Valve part no. (Stations 3 and 4)
- *VQ4300-51(-Q).....1 set—Valve part no. (Station 5)

Prefix the asterisk to the part nos. of the valve etc.

Enter in order starting from the first station on the D side. When entry of part numbers becomes complicated, indicate in the manifold specification sheet.

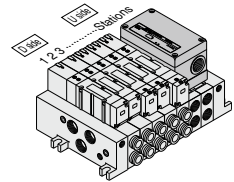

VQ 4 1 0 0 - 5 - - - 1 -

Series

4	VQ4000
---	--------

Type of actuation

1	2-position single
2	2-position double
3	3-position closed center
4	3-position exhaust center
5	3-position pressure center
6	3-position double check

Seal

0	Metal seal
1	Rubber seal

CE-compliant

Nil	—
Q	CE-compliant

Enclosure

Nil	Dust-protected
W	Dust-tight/ Water-jet-proof (IP65)

Manual override

Nil	Non-locking push type (Tool required)
B	Locking type (Tool required)
C	Locking type (Manual)

Light/Surge voltage suppressor

Nil	Yes
E	Without light, with surge voltage suppressor

Coil voltage

5	24 VDC
---	--------

Function

Nij	Note 1)	Standard (0.95 W)
Y	Note 2)	Low wattage type (0.4 W)
R	Note 3)	External pilot

- Note 1) When the unit is energized continuously, refer to "Specific Product Precautions 1" on page 533.
- Note 2) In addition, only DC is available with Y.
- Note 3) For external pilot specifications, refer to page 481. Combination of the external pilot and perfect interface is not possible.
- Note 4) When multiple symbols are specified, indicate them alphabetically.

- SV
- SYJ
- SZ
- VF
- VP4
- VQ 1/2
- VQ 4/5
- VQC 1/2
- VQC 4/5
- VQZ
- SQ
- VFS
- VFR
- VQ7

VQ4000 Series

S

Kit (Serial transmission unit): EX123/124 (For Output) Serial Transmission System

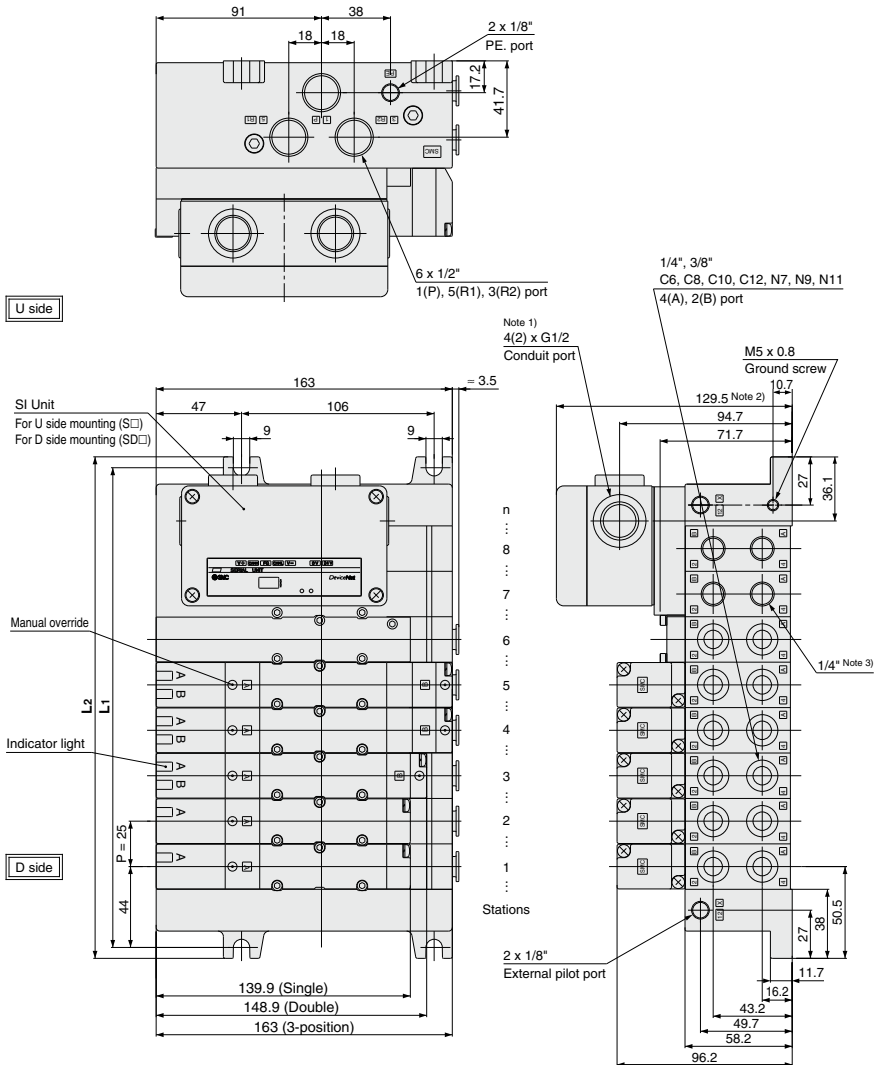

Note 1) In the case of EX124 for SI Unit, conduit port (G1/2) will be 4 locations. In the case of EX123D(U), conduit port will be 2 locations.
 Note 2) In the case of EX124D(U)-SMJ1, this dimension becomes 133.
 Note 3) 4(A) and 2(B) port at the bottom of the SI Unit are 1/4".

Figure shows VV5Q41-08C12SQ-W.

Formula: $L_1 = 25n + 63$, $L_2 = 25n + 76$ n: Stations (Maximum mounting 18 stations)
 * Including 2 stations for mounting SI Unit box.

Dimensions

L	n	3	4	5	6	7	8	9	10	11	12	13	14	15	16	17	18
L1		138	163	188	213	238	263	288	313	338	363	388	413	438	463	488	513
L2		151	176	201	226	251	276	301	326	351	376	401	426	451	476	501	526

Bottom ported drawing

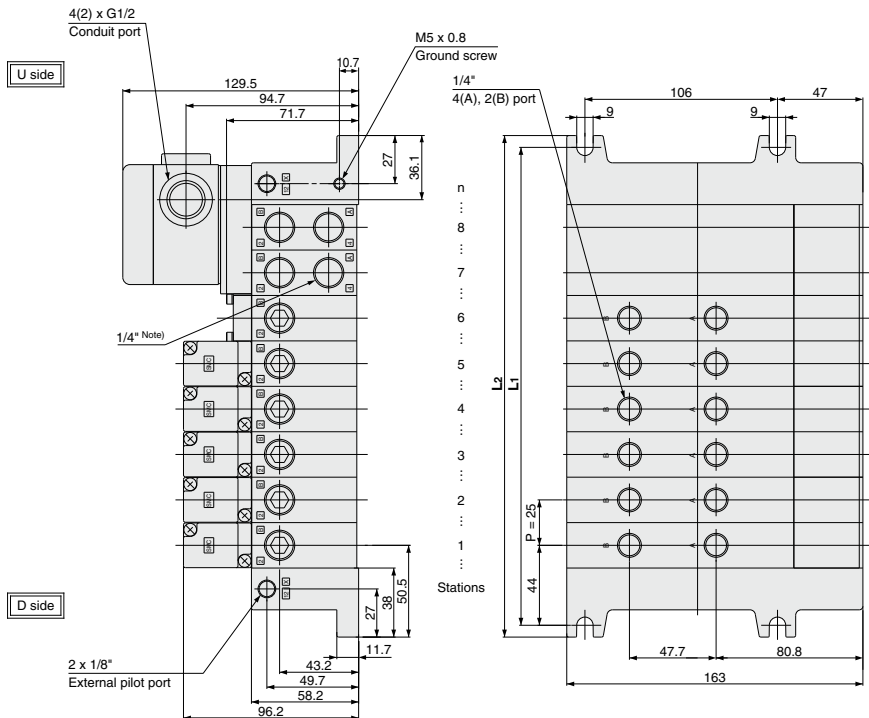

Note) 4(A) and 2(B) port at the bottom of the terminal block box are 1/4\".

- SV
- SYJ
- SZ
- VF
- VP4
- VQ 1/2
- VQ 4/5**
- VQC 1/2
- VQC 4/5
- VQZ
- SQ
- VFS
- VFR
- VQ7

Dimensions

Formula: $L_1 = 25n + 63$, $L_2 = 25n + 76$ n: Stations (Maximum standard 18 stations)
 * Including 2 stations for mounting SI Unit.

L \ n	3	4	5	6	7	8	9	10	11	12	13	14	15	16	17	18
L ₁	138	163	188	213	238	263	288	313	338	363	388	413	438	463	488	513
L ₂	151	176	201	226	251	276	301	326	351	376	401	426	451	476	501	526

Base Mounted

Plug Lead Unit: C Kit (Connector Kit)

VQ4000 Series



[Option]
Note) CE-compliant:
For DC only.

How to Order Manifold

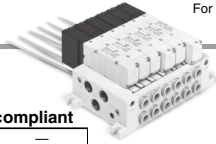

VV5Q 4 5 - 08 C8 [] C [] [] - [] - []

Series	4 VQ4000
Manifold	5 Plug lead unit
Stations	01 1 station ... 16 16 stations
Cylinder port	C6 ø6 One-touch fitting C8 ø8 One-touch fitting C10 ø10 One-touch fitting C12 ø12 One-touch fitting 02 1/4 03 3/8 B Bottom ported 1/4 CM Mixed N7 ø1/4" One-touch fitting N9 ø5/16" One-touch fitting N11 ø3/8" One-touch fitting
Thread type	Nil Nil Rc F F G N N NPT T T NPTF

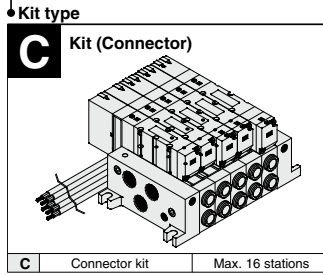

CE-compliant	Nil - Q CE-compliant
---------------------	-------------------------

Option	Symbol	Option
	Nil	None
	CD ^{Note 2)}	Exhaust cleaner: For D side mounting
	CU ^{Note 2)}	Exhaust cleaner: For U side mounting
	SB	Direct exhaust with silencer box: Exhaust from both sides
	SD ^{Note 2)}	Direct exhaust with silencer box: D side exhaust
	SU ^{Note 2)}	Direct exhaust with silencer box: U side exhaust
	W	IP65 enclosure

Note 1) When multiple symbols are specified, indicate them alphabetically.
Example) -CDW
Note 2) Combination of [C₆] and [S₁] is not available. Also, exhaust cleaner is not attached. Please order it separately.

Refer to page 534 (Grommet type) for wiring specifications.

Control unit
Refer to pages 482 to 485.

How to Order Valves

VQ 4 1 5 0 [] - 5 G [] [] [] 1 - []

Type of actuation	1 2-position single 2 2-position double 3 3-position closed center 4 3-position exhaust center 5 3-position pressure center 6 3-position double check
Seal	0 Metal seal 1 Rubber seal
Series	4 VQ4000
Function	Nil ^{Note 1)} Standard (0.95 W) Y ^{Note 2)} Low wattage type (0.4 W) R ^{Note 3)} External pilot

Note 1) When the unit is energized continuously, refer to "Specific Product Precautions 1" on page 533.
Note 2) In addition, only DC is available with Y.
Note 3) For external pilot specifications, refer to page 481. Combination of the external pilot and perfect interface is not possible.
Note 4) When multiple symbols are specified, indicate them alphabetically.

Coil voltage	1 100 VAC (50/60 Hz) 2 200 VAC (50/60 Hz) 3 110 VAC (50/60 Hz)	4 220 VAC (50/60 Hz) 5 24 VDC 6 12 VDC
---------------------	--	--

CE-compliant	Nil - Q CE-compliant Note) CE-compliant: For DC only.
Enclosure	Nil Dust-protected W Dust-tight/ Water-jet-proof (IP65)

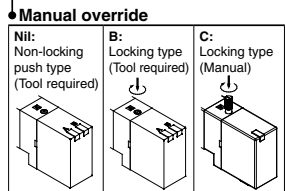

Light/Surge voltage suppressor	Nil Yes E Without light, with surge voltage suppressor
---------------------------------------	---

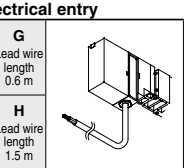

How to Order Manifold Assembly

Specify the part numbers for valves and options together beneath the manifold base part number.

<Example>
Connector kit
VV5Q45-05C12C(-Q)-1 set—Manifold base part no.
*VQ4150-5G1(-Q).....2 sets—Valve part no. (Stations 1 and 2)
*VQ4250-5G1(-Q).....2 sets—Valve part no. (Stations 3 and 4)
*VQ4350-5G1(-Q).....1 set—Valve part no. (Station 5)

Prefix the asterisk to the part nos. of the valve etc.

Enter in order starting from the first station on the D side. When entry of part numbers becomes complicated, indicate in the manifold specification sheet.

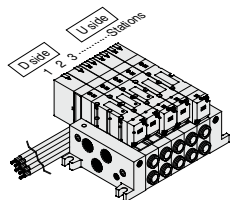

Manifold Specifications

Series	Base model	Type of connection	Porting specifications			Maximum applicable stations	Applicable valve	Weight [kg] (Formula)
			4(A), 2(B) port location	Port size				
				1(P), 5(R1), 3(R2)	4(A), 2(B)			
VQ4000	VVQ45-□□□	■ C kit-Grommet	Side	1/2 Option (Direct exhaust with silencer box)	C6 C8 C10 C12 1/4 3/8 N7 N9 N11	2 to 16 stations	VQ4□50 VQ4□51	0.31n + 0.55 • Not including valve weight.
			Bottom		1/4			

n: Stations

Flow Rate Characteristics at the Number of Manifold Stations (Operated individually)

Model	Passage/Stations	Station 1	Station 5	Station 10	Station 15	
2-position metal seal VQ4 $\frac{1}{2}$ 50	1 → 4/2 (P → A/B)	C [dm ³ /(s·bar)]	5.9	5.9	5.9	5.9
		b	0.23	0.23	0.23	0.23
		Cv	1.5	1.5	1.5	1.5
	4/2 → 5/3 (A/B → EA/EB)	C [dm ³ /(s·bar)]	6.2	6.2	6.2	6.2
		b	0.19	0.19	0.19	0.19
		Cv	1.5	1.5	1.5	1.5
2-position rubber seal VQ4 $\frac{1}{2}$ 51	1 → 4/2 (P → A/B)	C [dm ³ /(s·bar)]	6.8	6.8	6.8	6.8
		b	0.31	0.31	0.31	0.31
		Cv	1.8	1.8	1.8	1.8
	4/2 → 5/3 (A/B → EA/EB)	C [dm ³ /(s·bar)]	7.0	7.0	7.0	7.0
		b	0.38	0.38	0.38	0.38
		Cv	1.9	1.9	1.9	1.9

Note) Port size: 3/8

Manifold Options

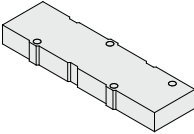
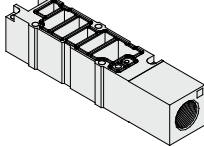
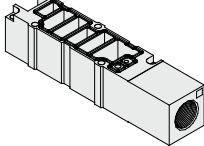
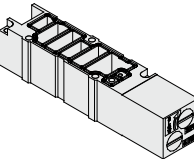
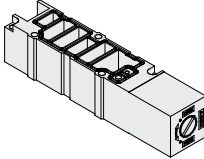
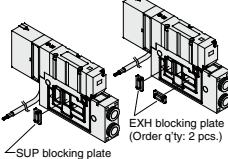
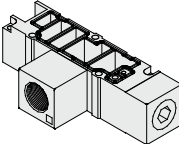
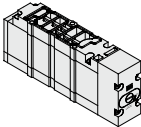
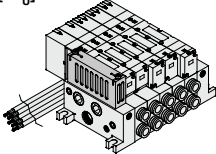
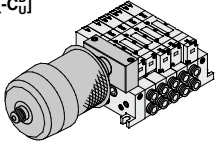
<p>Blanking plate assembly VVQ4000-10A-5</p> 	<p>Individual SUP spacer VVQ4000-P-5-$\frac{02}{03}$</p> 	<p>Individual EXH spacer VVQ4000-R-5-$\frac{02}{03}$</p> 	<ul style="list-style-type: none"> • Refer to pages 476 to 480 for detailed dimensions of each option. • For replacement parts, refer to page 489. • Refer to pages 482 to 485 for control unit.
<p>Restrictor spacer VVQ4000-20A-5</p> 	<p>SUP stop valve spacer VVQ4000-37A-5</p> 	<p>SUP/EXH block plate VVQ4000-16A (1 pc./set)</p>  <p>EXH blocking plate (Order q'ty: 2 pcs.)</p> <p>SUP blocking plate</p>	
<p>Release valve spacer: For D side mounting VVQ4000-24A-5D (Note)</p> 	<p>Double check spacer with residual pressure exhaust VVQ4000-25A-5 (Note)</p> 	<p>Direct exhaust with silencer box [-S$\frac{D}{1}$]</p> 	<p>Manifold mounted exhaust cleaner [-C$\frac{D}{1}$]</p> 

Note) Release valve spacer and double check spacer with residual pressure exhaust cannot be combined with external pilot.

VQ4000 Series

C Kit (Connector kit)

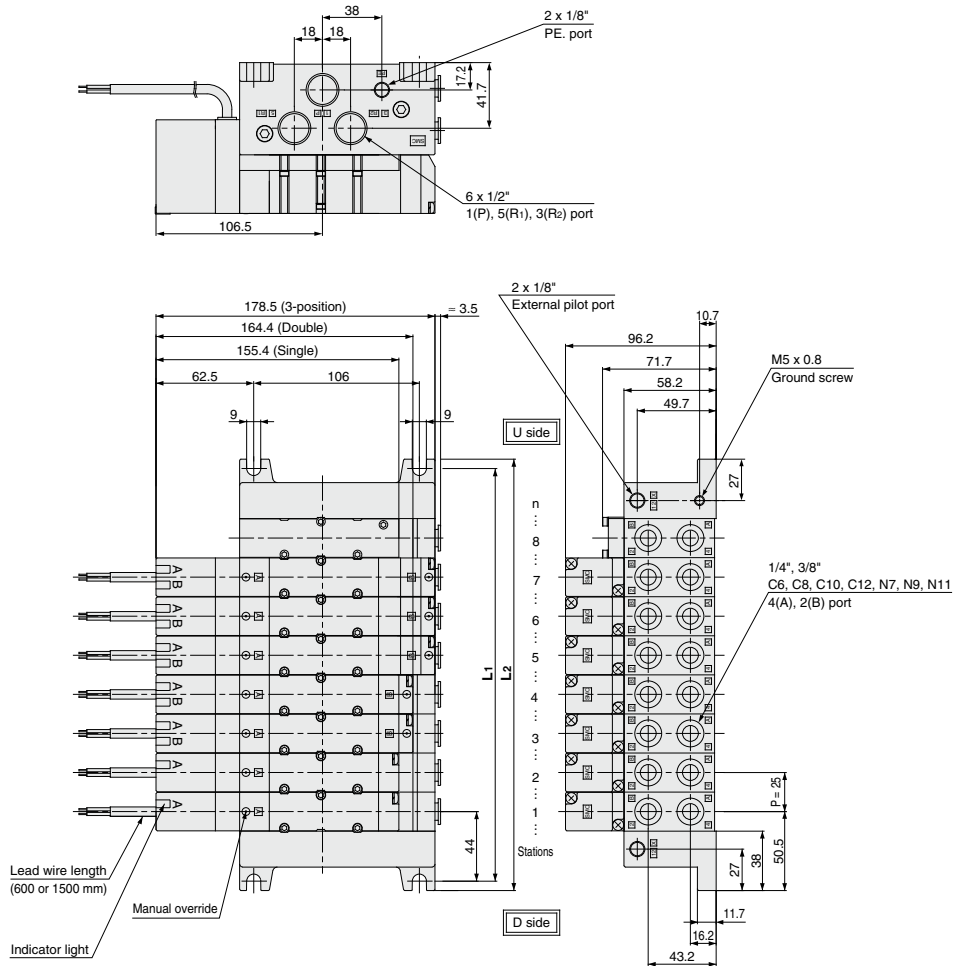

Bottom ported drawing

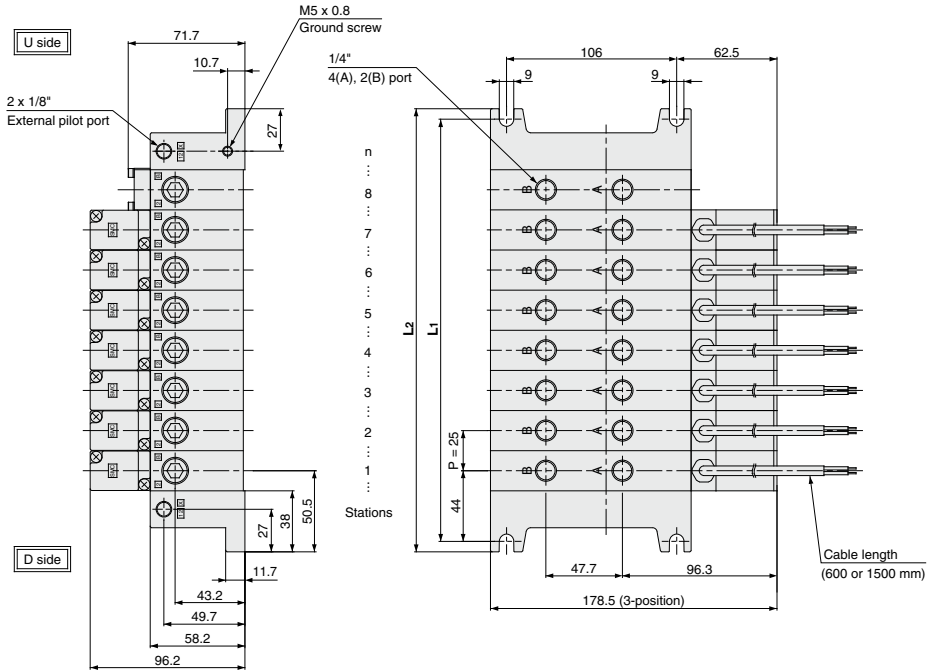

SV
SYJ
SZ
VF
VP4
VQ 1/2
VQ 4/5
VQC 1/2
VQC 4/5
VQZ
SQ
VFS
VFR
VQ7

Dimensions

Formula: $L_1 = 25n + 63$, $L_2 = 25n + 76$ n: Stations (Maximum 16 stations)

L \ n	1	2	3	4	5	6	7	8	9	10	11	12	13	14	15	16
L1	88	113	138	163	188	213	238	263	288	313	338	363	388	413	438	463
L2	101	126	151	176	201	226	251	276	301	326	351	376	401	426	451	476

VQ4000 Series Manifold Options

Manifold Option Parts

Blanking plate assembly

VVQ4000-10A-1 (Plug-in type)

VVQ4000-10A-5 (Plug lead type)

It is used by attaching on the manifold block for being prepared for a valve for maintenance reasons or planning to mount a spare valve etc.

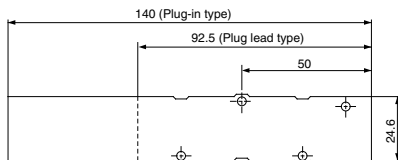
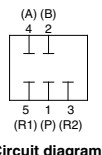
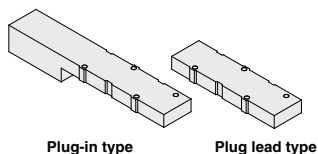

Individual SUP spacer

VVQ4000 - P - 1 - 02

Manifold	
1	Plug-in type
5	Plug lead type

Port size	
02	1/4
03	3/8

Thread type	
Nil	Rc
F	G
N	NPT
T	NPTF

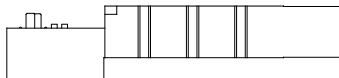
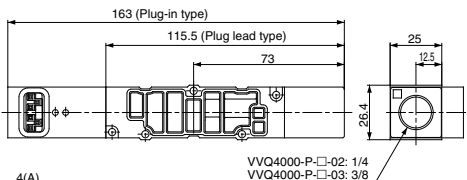
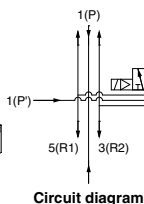
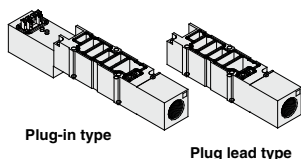

Individual EXH spacer

VVQ4000 - R - 1 - 02

Manifold	
1	Plug-in type
5	Plug lead type

Port size	
02	1/4
03	3/8

Thread type	
Nil	Rc
F	G
N	NPT
T	NPTF

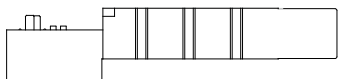
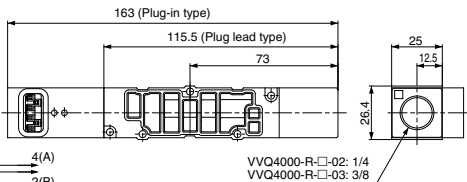
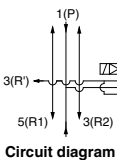
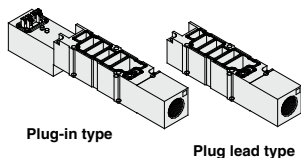

Restrictor spacer

VVQ4000-20A-1 (Plug-in type)
VVQ4000-20A-5 (Plug lead type)

A restrictor spacer is mounted on a manifold block to control cylinder speed by throttling exhaust air flow.

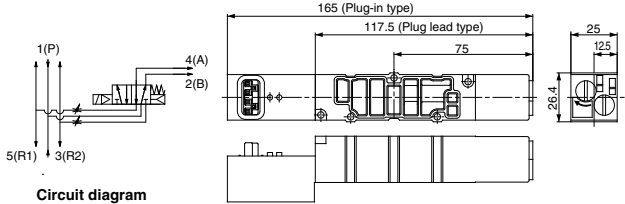
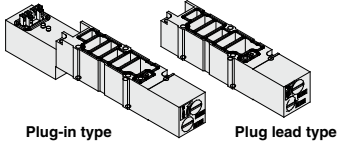

Circuit diagram

Note 1) A certain amount of leakage is allowed in the products' specifications. Tightening the needle to reduce leakage to zero may result in equipment damage.
 Note 2) Products mentioned in this catalog are retainer types, so the needle is not removed completely. Over rotation will cause damage.

SUP stop valve spacer

VVQ4000-37A-1 (Plug-in type)
VVQ4000-37A-5 (Plug lead type)

A SUP stop valve spacer is mounted on a manifold block, making it possible to individually shut off supply air to each valve.

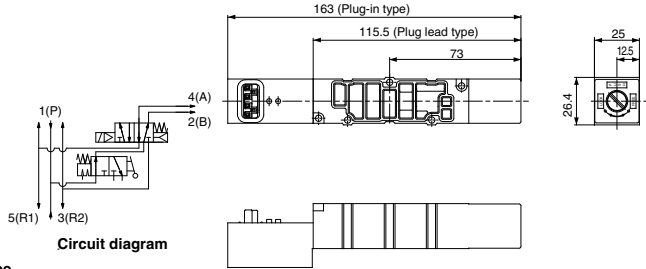
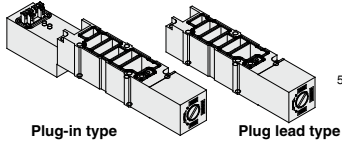

Circuit diagram

Release valve spacer: For D side mounting

VVQ4000-24A-1D (Plug-in type)
VVQ4000-24A-5D (Plug lead type)

Combination of VQ41□□ (Single) and release valve spacer can be used as air release valve.

Note 1) Mounting on 2-position double and 3-position valve is not possible.
 Note 2) Can be mounted on L kit only. For other kits, order E type control unit. (Refer to pages 482 to 485.)

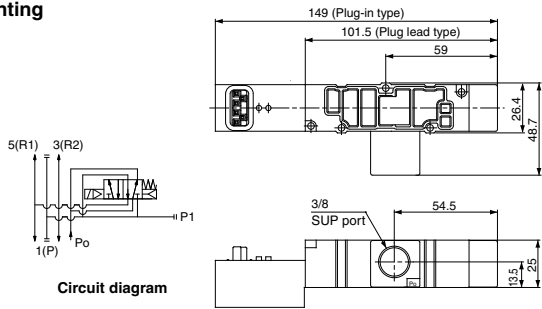
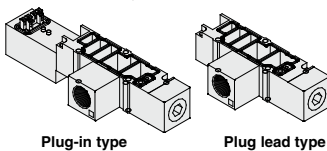

Circuit diagram

SUP/EXH block plate

VVQ4000-16A (1 pc./set)

When supplying two different pressures to one manifold, this is used to shut off between stations with different pressures.

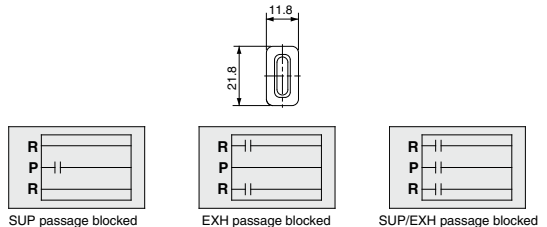
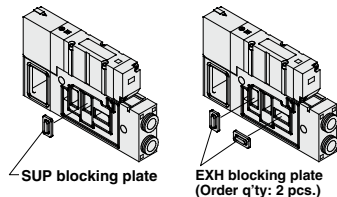

<Passage blocked label>

Indication labels to confirm the blocking position are attached. (Each for SUP passage, EXH passage, and SUP/EXH passage blocking positions)

SV
SYJ
SZ
VF
VP4
VQ 1/2
VQ 4/5
VQC 1/2
VQC 4/5
VQZ
SQ
VFS
VFR
VQ7

VQ4000 Series

Manifold Option Parts

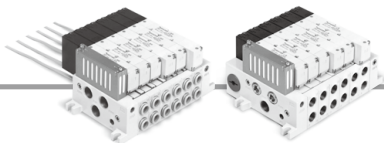

Direct exhaust with silencer box

VV5Q4 $\frac{1}{2}$ -□□□-SB (Exhaust from both sides)

VV5Q4 $\frac{1}{2}$ -□□□-SD (D side exhaust)

VV5Q4 $\frac{1}{2}$ -□□□-SU (U side exhaust)

The EXH outlet is placed on the top side of the manifold end plate. The built-in silencer provides highly effective noise reduction. (Noise reduction of 35 dB(A) or more)

Effective area: 60.2 mm²

Note) Note that when excessive drainage occurs in the air supply, the drainage will be released along with the exhaust.

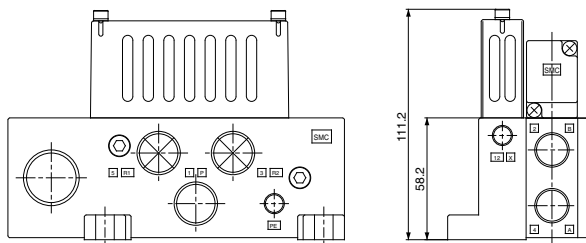
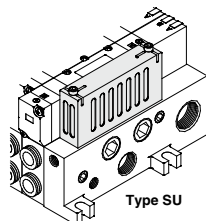
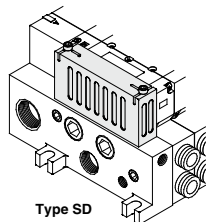
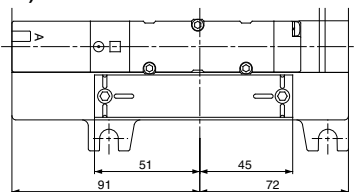

Note) Figure shows VV5Q41-□□□-SD.

• Silencer box assembly: VVQ4000-33A (With gasket, screw)

Double check spacer with residual pressure exhaust

VVQ4000-25A-1 (Plug-in type)

VVQ4000-25A-5 (Plug lead type)

Can hold an intermediate cylinder position for an extended time.

When combined with a double check spacer with built-in double check valve, it is unaffected by air leakage between the spool valves, making it possible to hold a cylinder at an intermediate stopping position for an extended time.

Besides, combination between 2-position solenoid valve (VQ4 $\frac{2}{3}$ □□) and double check spacer cannot hold an intermediate position, but can be used for drop prevention at the cylinder stroke end.

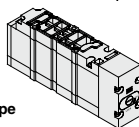
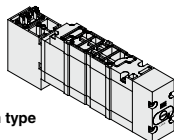

Specifications

Double check spacer part no.	VVQ4000-25A- $\frac{1}{5}$	
	Intermediate stop	Drop prevention
Applicable solenoid valve	VQ44□□	VQ4 $\frac{2}{3}$ □□

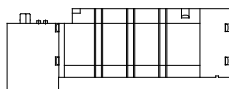
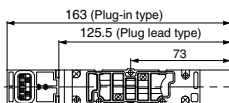

⚠ Caution

Handling Precautions

- In the case of 3-position double check (VQ46 $\frac{2}{3}$ 0), check the leakage from piping and fittings in between valve and cylinder by means of synthetic detergent solutions, and ensure that there is no such leakage found there. Also, check the leakage from cylinder seal and piston seal. If there is any leakage, sometimes the cylinder, when valve is de-energized, can move without stopping at intermediate position.
- Since One-touch fittings allow slight air leakage, screw piping is recommended when stopping the cylinder in the middle for a long time.
- If exhaust side of double check spacer is narrowed down, this causes a decrease in intermediate stop accuracy and may malfunction.
- Combining with 3-position valves "VQ4 $\frac{2}{3}$ □□" is not possible.
- Set the cylinder load so that the cylinder pressure will be within two times that of the supply pressure.
- Combining double check spacer with external pilot is not possible.

Manual override for residual pressure exhaust
Slotted locking type (Tool required)

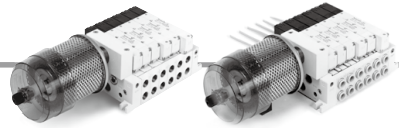

Manifold mounted exhaust cleaner

VV5Q4 □-□□□-CD (D side mounting)

VV5Q4 □-□□□-CU (U side mounting)

An adapter plate for exhaust cleaner mounting is provided on the top of the manifold end plate. The exhaust cleaner collects drainage and oil mist (99.9% or more) and is highly effective for noise reduction.
(Noise reduction of 35 dB(A) or more)

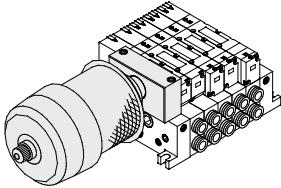

Applicable exhaust cleaner
AMC610-10 (Port size Rc 1)

Note 1) Exhaust cleaner AMC610-10 is not attached.

Please order it separately.

Note 2) Mount so that the exhaust cleaner is at the lower side.

Note 3) For details about the exhaust cleaner, refer to Best Pneumatics No. 7.

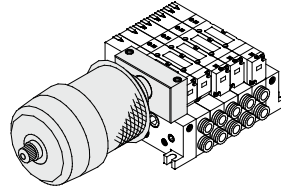

Plug-in type

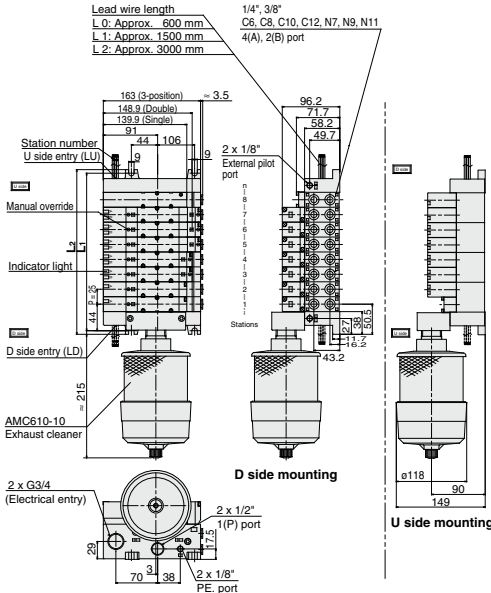

Plug lead type

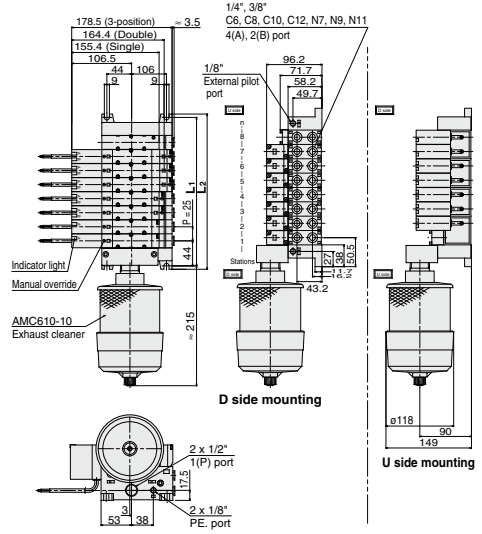

Dimensions

Formula: L1 = 25n + 63, L2 = 25n + 76
n: Stations (Maximum 16 stations)

L	n	1	2	3	4	5	6	7	8
L1		88	113	138	163	188	213	238	263
L2		101	126	151	176	201	226	251	276

L	n	9	10	11	12	13	14	15	16
L1		288	313	338	363	388	413	463	463
L2		301	326	351	376	401	426	476	476

Dimensions

Formula: L1 = 25n + 63, L2 = 25n + 76
n: Stations (Maximum 16 stations)

L	n	1	2	3	4	5	6	7	8
L1		88	113	138	163	188	213	238	263
L2		101	126	151	176	201	226	251	276

L	n	9	10	11	12	13	14	15	16
L1		288	313	338	363	388	413	463	463
L2		301	326	351	376	401	426	476	476

SV

SYJ

SZ

VF

VP4

VQ

1/2

VQ

4/5

VQC

1/2

VQC

4/5

VQZ

SQ

VFS

VFR

VQ7

VQ4000 Series

Manifold Option Parts

Interface regulator (P, A, B port regulation)

ARBQ4000-00-□-1 (Plug-in type)

ARBQ4000-00-□-5 (Plug lead type)

Spacer Interface regulators can be placed on top of the manifold block to reduce the pressure of each of the valves.

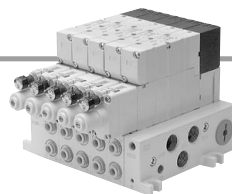

Specifications

Interface regulator		ARBQ4000					
Regulating port		A		B		P	
Applicable valve		Plug-in	Plug lead	Plug-in	Plug lead	Plug-in	Plug lead
Maximum operating pressure		1.0 MPa					
Set pressure range		0.05 to 0.85 MPa					
Fluid		Air					
Ambient and fluid temperature		-5 to 60°C (No freezing)					
Port size for connection of pressure gauge		M5 x 0.8					
Weight [kg]		0.33	0.30	0.33	0.30	0.33	0.30
Effective area at supply side [mm ²]	P → A	15		31		14	
S at P ₁ = 0.7 MPa/P ₂ = 0.5 MPa	P → B	35		16		15	
Effective area at exhaust side [mm ²]	A → EA	18		40		40	
S at P ₂ = 0.5 MPa	B → EB	37		19		37	

Note 1) Set the pressure within the operating pressure range of the valve.

Note 2) Operate an interface regulator only by applying pressure from the P port of the base, except when using it as a reverse pressure valve. When using it as a reverse pressure valve, P port regulation is not allowed to use.

Note 3) When using a perfect spacer, assemble a valve, a spacer regulator and a perfect spacer in this order to use it.

Note 4) When using in A port regulation, B port regulation by closed center, since there is a problem in its operation, please contact SMC.

Note 5) Dust-tight/Water-jet-proof (IP65) is not available with interface regulator.

How to Order

Valve model	Interface regulator	Regulating port
VQ4□0□ (Plug-in type)	ARBQ4000-00-A-1	A
	ARBQ4000-00-B-1	B
	ARBQ4000-00-P-1	P
VQ4□5□ (Plug lead type)	ARBQ4000-00-A-5	A
	ARBQ4000-00-B-5	B
	ARBQ4000-00-P-5	P

Dimensions

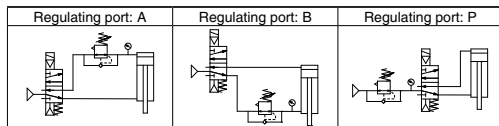
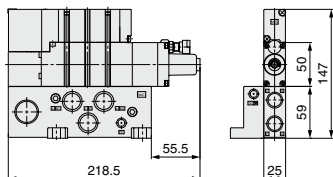

Flow Rate Characteristics

Conditions Inlet pressure: 0.7 MPa

ARBQ4000-00-A

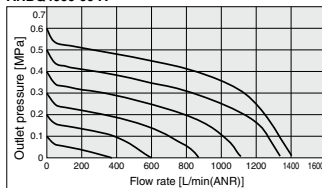

ARBQ4000-00-B

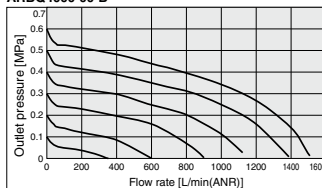

ARBQ4000-00-P (P → A)

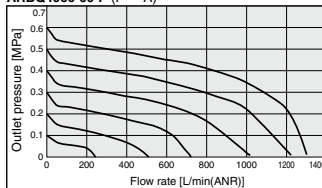

ARBQ4000-00-P (P → B)

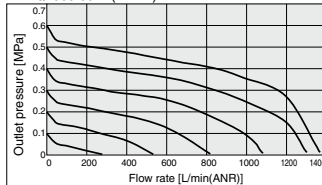

Pressure Characteristics

Conditions

Inlet pressure: 0.7 MPa

Outlet pressure: 0.2 MPa

Flow rate: 20 L/min (ANR)

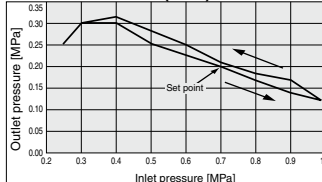

VQ4000 Series

Semi-standard Specifications

External Pilot Specifications

- When the supply air pressure is:
 - lower than the required minimum operating pressure 0.15 to 0.2 MPa,
 - opposite air supply (R port supply), cylinder supply (A and B port supply),
 - used for vacuum specification, it can be used for external pilot specification.
- Order a valve by adding the external pilot specification [R] to the part number. External pilot is available as standard for manifolds and options.
- Internal/external pilot can be mounted in a manifold.
- Compatibility with universal porting is possible for the single, double and 3-position (excluding double check) types.

How to Order Valves

VQ4100 **R** - 5 - 03

● External pilot

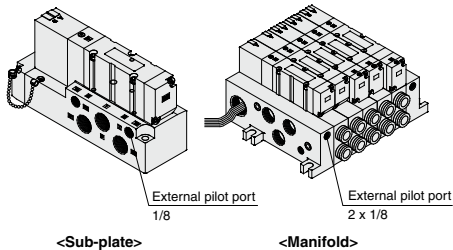

<Sub-plate>

<Manifold>

Note) Possible to mix mounting of internal and external pilot

Pressure Specifications

Valve construction	Metal seal	Rubber seal
Operating pressure range		
-100 kPa to 1.0 MPa		
External pilot pressure range	Single	0.2 to 1.0 MPa
	Double	0.15 to 1.0 MPa
	3-position	0.2 to 1.0 MPa

Combination of manifold options shown below and external pilot specification is not possible.

Release valve spacer	VVQ4000-24A-□D
Manifold with control unit	VV5Q4□-□□□ □ Control unit model no.
Double check spacer with residual pressure exhaust	VVQ4000-25A- $\frac{1}{5}$

SV

SYJ

SZ

VF

VP4

VQ
1/2

VQ
4/5

VQC
1/2

VQC
4/5

VQZ

SQ

VFS

VFR

VQ7

VQ4000 Series Manifold with Control Unit

- Mounting air filter, regulator, pressure switch for air release valve on manifold as unit is possible and permits piping labor savings.
- Maximum number of stations depends on each kit.
Refer to manifold specifications.
- 2 stations are used for control unit mounting.
(1 station is used for E type.)

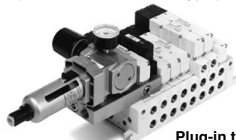

Plug-in type

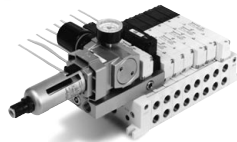

Plug lead type

Caution

In the case of air filters with auto-drain or manual drain, mount so that the air filter is at the bottom.

Manifold Specifications

Base model	Type of connection	4(A), 2(B) port location	Porting specifications		Applicable max. stations ^(Note)	Applicable valve
			Port size			
VV5Q41 □□□	F kit – D-sub connector T kit – Terminal block box L kit – Lead wire	Side	1/2 Option (Direct exhaust with silencer box)	4(A), 2(B)	F, T kit 14 stations (13 stations) L, C kit 18 stations (17 stations)	VQ4□00 VQ4□01
				1(P), 5(R1), 3(R2)		
VV5Q45 □□□	C kit – Connector	Bottom		1/4		VQ4□50 VQ4□51

Note) Manifold for mounting is included. () : E type

Control Unit Specifications

Air filter (With auto-drain/With manual drain)	
Filtration	5 μm
Regulator	
Set pressure (Outlet pressure)	0.05 to 0.85 MPa
Pressure switch ^{Note 1)}	
Set pressure range: OFF	0.1 to 0.6 MPa
Differential	0.08 MPa or less
Contact	1a
Light	LED (RED)
Max. switch capacity	2 VA (AC), 2 W (DC)
Max. operating current	50 mA at 24 VAC, DC or less 20 mA at 100 VAC, DC
Air release valve (Single only)	
Operating pressure range	0.15 to 1 MPa

Control Unit/Option

Air release valve	VQ4 ⁰⁰ _Y 5 ⁰ _H (^G)1(-Q)
Air release valve spacer ^{Note 2)}	<Plug-in type> VVQ4000-24A-1D <Plug lead type> VVQ4000-24A-5D
Pressure switch	IS1000P-2-1
Blanking plate ^{Note 3)}	Regulator with filter MP2-3 Pressure switch MP3-2
Release valve	Plug-in VVQ4000-24A-10 Plug lead VVQ4000-24A-15
Filter element	INA-13-854-12-5B

Note 1) Rated voltage: 24 VDC to 100 VAC
Internal voltage drop: 4 V

Note 2) Combination of VQ41□□ (Single) and release valve spacer can be used as air release valve.

Note 3) Plug lead type can not be mounted later.

How to Order

VV5Q 4 1 - 08 C8 **F U1** **CE-compliant**

Series: 4 VQ4000

Manifold: 1 Plug-in unit, 5 Plug lead unit

Stations: 02 2 stations

Cylinder port: C6 ø6 One-touch fitting, C8 ø8 One-touch fitting, C10 ø10 One-touch fitting, C12 ø12 One-touch fitting, 02 1/4, 03 3/8, B Bottom ported 1/4, CM Mixed, N7 ø1/4" One-touch fitting, N9 ø5/16" One-touch fitting, N11 ø3/8" One-touch fitting

Kit: Nil Without air release valve (Only F, G type), 51 24 VDC

Air release valve coil rating: Nil Without air release valve (Only F, G type), 51 24 VDC

Control unit type: Nil, A, AP, M, MP, F, G, C, E

Thread type: Nil Rc, F G, N NPT, T NPTF

Option: Nil, Q CE-compliant

Note) CE-compliant: For DC only.

Symbol	Nil	A	AP	M	MP	F	G	C	E
Control equipment									
Air filter with auto-drain	●	●				●			
Air filter with manual drain				●	●	●			
Regulator		●	●			●			
Air release valve		●	●	●	●			●	●
Pressure switch						●			
Blanking plate (Air release valve)						●			
Blanking plate (Filter, Regulator)								●	
Blanking plate (Pressure switch)									●
Necessary number of manifold blocks for mounting (Stations)	2 stations	2 stations	2 stations	2 stations	2 stations	2 stations	2 stations	2 stations	1 station

Note 1) When multiple symbols are specified, indicate them alphabetically. Example) -KN

Note 2) Specify wiring on the manifold specification sheet.

Note 3) Mounting on S and T kits is not possible.

Note 4) For the types with a pressure switch (AP and MP types), the pressure switch enclosure is IP40.

Note 5) The release valve and the pressure switch on S kit are connected to another power supply. Cable length is 0.6 m.

Note) Electrical entry: Control unit can not be removed except L and C kits.

Use of Control Unit

<Construction and piping>

- The supply pressure (Po) passes through the filter regulator (1) and is adjusted to the prescribed pressure. Next, it goes through the release valve (2) (outlet residual pressure switching function used as normally ON) and is supplied to the manifold base side (P).
- Supply pressure from Po port is blocked when release valve (2) is OFF. Air supplied to manifold side P port is exhausted to R1 port through release valve (2).
- Pressure switch is piped at outlet side of release valve (2). (Release valve (2) is operated at energizing.)
Also, since there is an internal voltage drop of 4 V, it may not be possible to confirm the OFF and ON states with a tester, etc.

<Wiring>

- Electrical entry of manifold (except L and C kit) is individual wiring. For details, refer to internal wiring figure of each kit. Cable length is 0.6 m for L kit.

<Change of pressure switch piping>

- Pressure switch (3) is changed to piping on inlet side of release valve (2), remove the pressure switch, reverse the gasket up and down, and fix **[B]** mark.
- When pressure switch is mounted, tightening torque of bolt is 0.8 to 1.2 N·m.

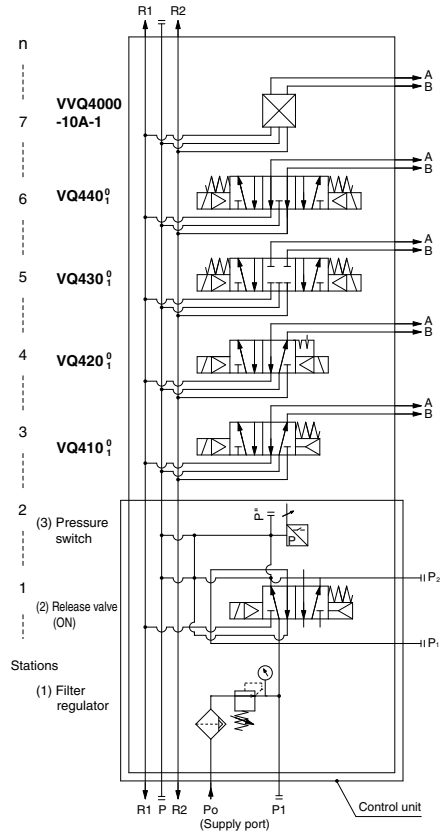
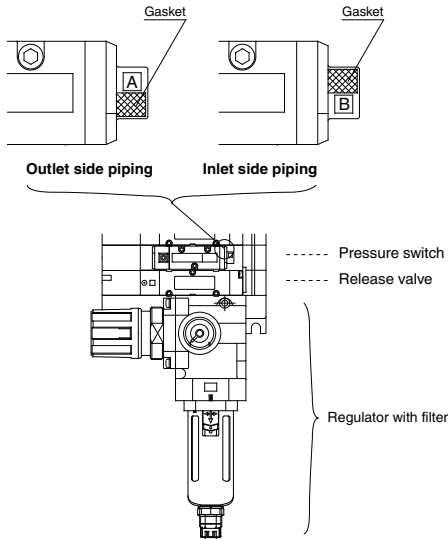

Circuit of control unit manifold

SV
SYJ
SZ
VF
VP4
VQ 1/2
VQ 4/5
VQC 1/2
VQC 4/5
VQZ
SQ
VFS
VFR
VQ7

VQ4000 Series

Dimensions

Plug-in type

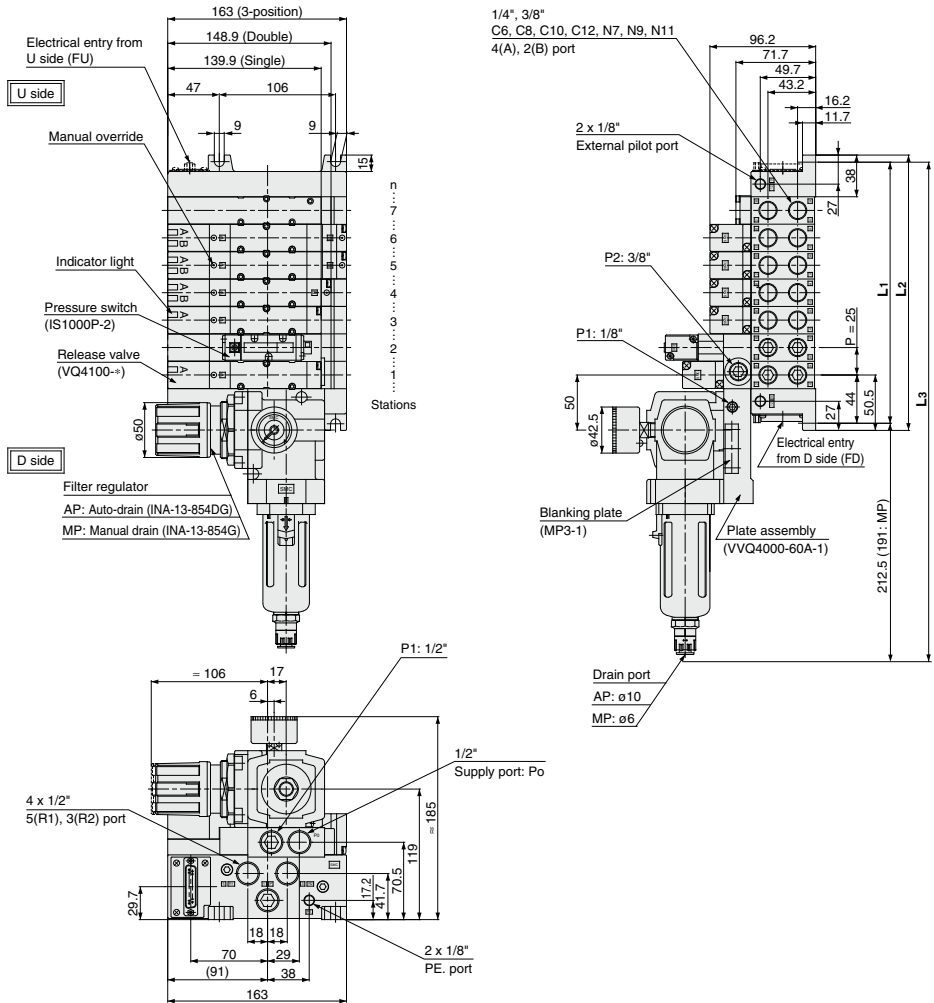

Dimensions

Formula: $L_1 = 25n + 63$, $L_2 = 25n + 76$, $L_3 = 25n + 282$ (260.5) n: Stations

L	n	2	3	4	5	6	7	8	9	10	11	12
L ₁		113	138	163	188	213	238	263	288	313	338	363
L ₂		126	151	176	201	226	251	276	301	326	351	376
L ₃		332	357	382	407	432	457	482	507	532	557	582
		(310.5)	(335.5)	(360.5)	(385.5)	(410.5)	(435.5)	(460.5)	(485.5)	(510.5)	(535.5)	(560.5)

* L₃ (): Type MP

Plug lead type

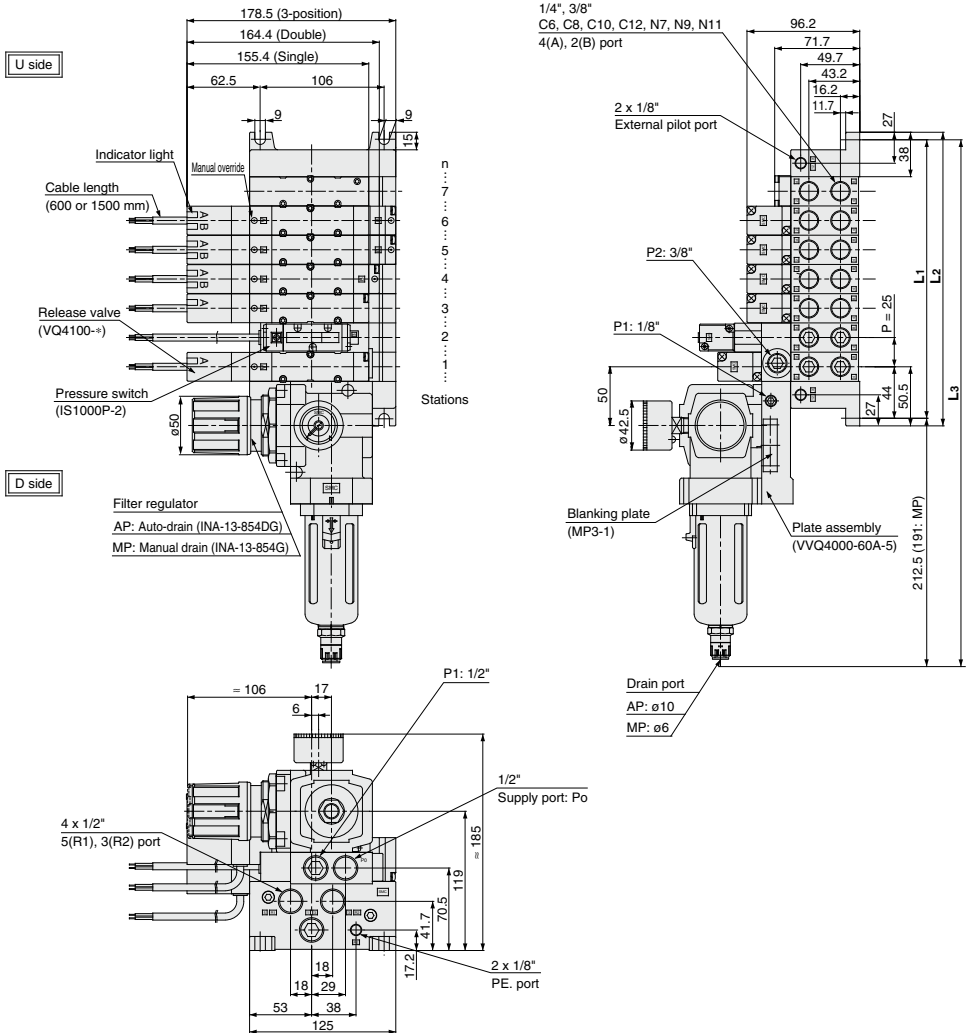

- SV
- SYJ
- SZ
- VF
- VP4
- VQ 1/2
- VQ 4/5**
- VQC 1/2
- VQC 4/5
- VQZ
- SQ
- VFS
- VFR
- VQ7

Dimensions

Formula: $L_1 = 25n + 63$, $L_2 = 25n + 76$, $L_3 = 25n + 282$ (260.5) n: Stations

L	n	2	3	4	5	6	7	8	9	10	11	12
L ₁		113	138	163	188	213	238	263	288	313	338	363
L ₂		126	151	176	201	226	251	276	301	326	351	376
L ₃		332	357	382	407	432	457	482	507	532	557	582
		(310.5)	(335.5)	(360.5)	(385.5)	(410.5)	(435.5)	(460.5)	(485.5)	(510.5)	(535.5)	(560.5)

* L₃ (): Type MP

VQ4000 Series Construction

Plug-in Unit

Metal seal type

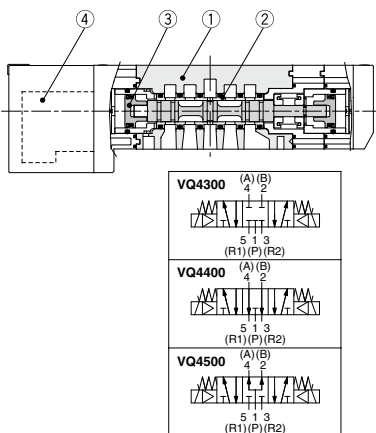
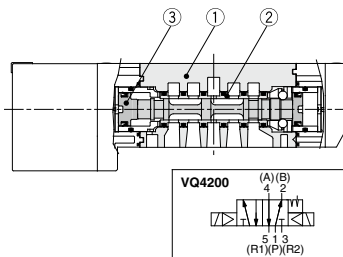
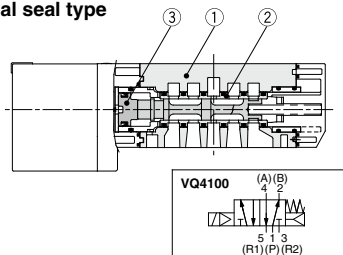

Component Parts

Number	Description	Material	Note
1	Body	Aluminum die-casted	
2	Spool/Sleeve	Stainless steel	
3	Piston	Resin	

Replacement Parts

4	Pilot valve assembly		<input type="checkbox"/> Coil rated voltage Example) 24 VDC: 5 A: With light (For A side) B: With light (For B side) E: Without light (A/B side common)

Rubber seal type

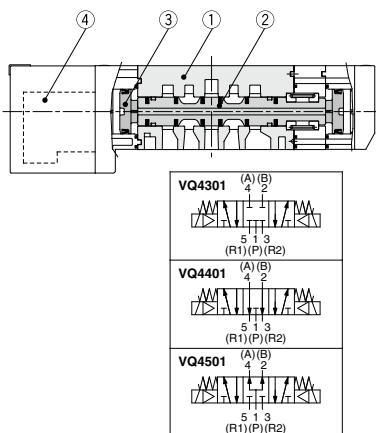
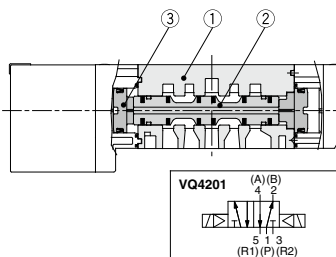
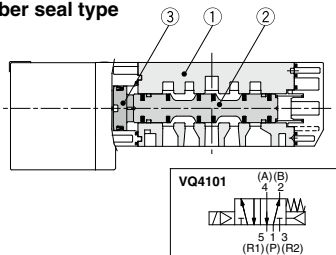

Component Parts

Number	Description	Material	Note
1	Body	Aluminum die-casted	
2	Spool valve	Aluminum, HNBR	
3	Piston	Resin	

Replacement Parts

4	Pilot valve assembly		<input type="checkbox"/> Coil rated voltage Example) 24 VDC: 5 A: With light (For A side) B: With light (For B side) E: Without light (A/B side common)

Plug Lead Unit

Metal seal type

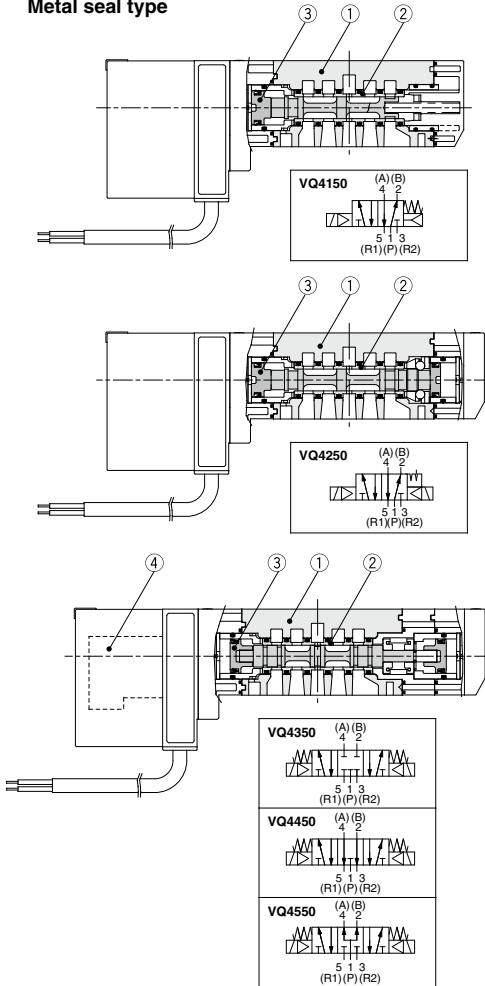

Component Parts

Number	Description	Material	Note
1	Body	Aluminum die-casted	
2	Spool/Sleeve	Stainless steel	
3	Piston	Resin	

Replacement Parts

4	Pilot valve assembly		□: Coil rated voltage Example) 24 VDC: 5 A: With light (For A side) B: With light (For B side) E: Without light (A/B side common)	
				•Coil type <table border="1"> <tr> <td>Nil</td> <td>Standard (0.95W)</td> </tr> <tr> <td>Y</td> <td>Low wattage type (0.4W)</td> </tr> </table>
Nil	Standard (0.95W)			
Y	Low wattage type (0.4W)			

Rubber seal type

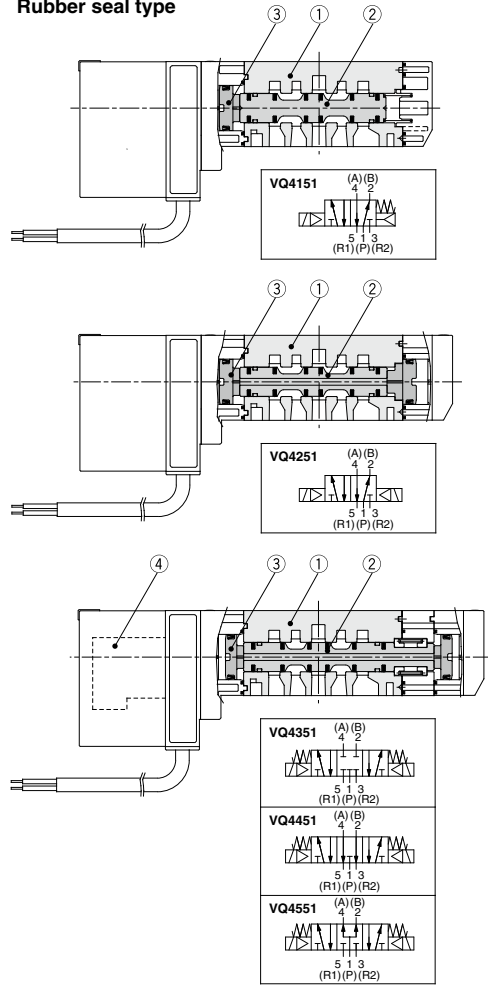

Component Parts

Number	Description	Material	Note
1	Body	Aluminum die-casted	
2	Spool valve	Aluminum, HNBR	
3	Piston	Resin	

Replacement Parts

4	Pilot valve assembly		□: Coil rated voltage Example) 24 VDC: 5 A: With light (For A side) B: With light (For B side) E: Without light (A/B side common)	
				•Coil type <table border="1"> <tr> <td>Nil</td> <td>Standard (0.95W)</td> </tr> <tr> <td>Y</td> <td>Low wattage type (0.4W)</td> </tr> </table>
Nil	Standard (0.95W)			
Y	Low wattage type (0.4W)			

- SV
- SYJ
- SZ
- VF
- VP4
- VQ 1/2
- VQ 4/5
- VQC 1/2
- VQC 4/5
- VQZ
- SQ
- VFS
- VFR
- VQ7

VQ4000 Series

Exploded View of Manifold

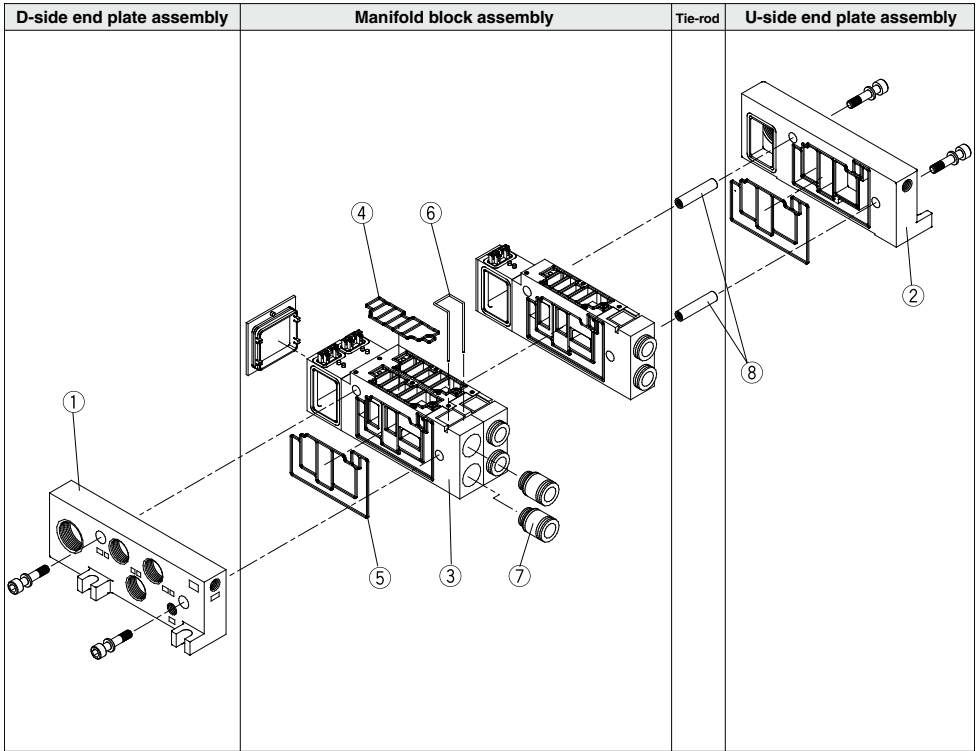

Note) The electrical entry cannot be changed.

Figure shows a plug-in type.

D side

U side

Example) 1.....2.....3.....4.....5.....6.....Stations

5 stations (Odd number) 2 stations | 2 stations | 1 station

6 stations (Even number) 2 stations | 2 stations | 2 stations

D-Side End Plate Assembly

1. D-side end plate assembly part no. (For F, L, S, T kit)

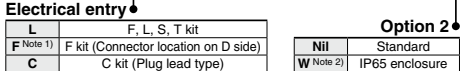
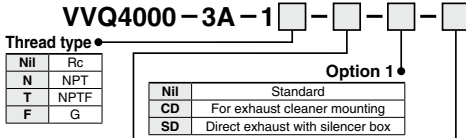

Note 1) D-sub connector assembly for D side: VVQ4000-19A-D is not included. (Order separately)

Note 2) Drip proof type for F kit is not available.

D-sub connector assembly

D-sub connector assembly

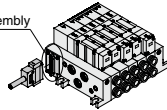

U-Side End Plate Assembly

2. U-side end plate assembly part no. (For F, L, S, T kit)

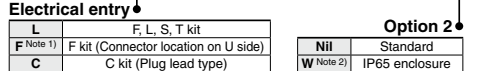
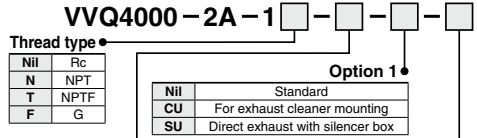

Note 1) D-sub connector assembly for U side: VVQ4000-19A-U is not included. (Order separately)

Note 2) Drip proof type for F kit is not available.

VVQ4000-19A-

D	D side entry
U	U side entry

Manifold Block Assembly

3. Manifold block assembly part no. (Including ④, ⑤ and ⑥)

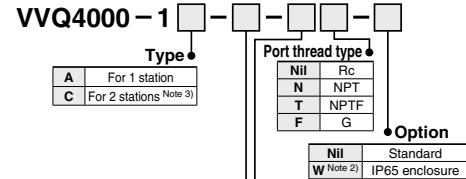

Electrical entry

F1	F kit Double wiring
F2	F kit Single wiring
T1	T kit Double wiring
T2	T kit Single wiring
S1	S kit Double wiring
S2	S kit Single wiring
L0	L0 kit □: Stations (1 to 16)
L1	L1 kit □: Stations (1 to 16)
L2	L2 kit □: Stations (1 to 16)
C	C kit (Plug lead type)

Port size

02	1/4
03	3/8
B	Bottom ported 1/4 Note 4)
C6	With One-touch fitting for ø6
C8	With One-touch fitting for ø8
C10	With One-touch fitting for ø10
C12	With One-touch fitting for ø12
N7	With One-touch fitting for ø1/4
N9	With One-touch fitting for ø5/16
N11	With One-touch fitting for ø3/8

Note 1) Tie-rods (2 pcs.) and lead wire assembly for station addition included.

Note 2) Dripproof F kit is not available.

Note 3) When ordering block assembly for L kit 2 stations, the lead wire should be ordered by the smaller numbers of the D side (no. of station).

Note 4) Bottom ported type: For 1-station type only.

Manifold Block Replacement Parts

Replacement Parts

No.	Part no.	Description	Material	Qty
④	VVQ4000-80A-1	Gasket	HNBR	10
⑤	VVQ4000-80A-2	Gasket	HNBR	10
⑥	VVQ4000-80A-4	Clip	Stainless steel	10

Note) Spare parts consist of sets containing 10 pcs. each.

Fitting Assembly

7. Fitting assembly part no. (For cylinder port)

VVQ4000-50B-

Port size

C6	Applicable tubing ø6
C8	Applicable tubing ø8
C10	Applicable tubing ø10
C12	Applicable tubing ø12
N7	Applicable tubing ø1/4
N9	Applicable tubing ø5/16
N11	Applicable tubing ø3/8

Note) Purchasing order is available in units of 10 pieces.

8. Tie-rods part no. (2 pcs.)

VVQ4000-TR-

Stations: 02 to 18



Note) When eliminating manifold stations, order this separately. When increasing manifold stations, it is not necessary to order since tie-rods are included in the manifold block assembly.

Housing Assembly and SI Unit

Kit type	Model symbol	Part no.	Description
S (Serial transmission unit)	0	—	Without SI Unit
	H	EX123 ⁰ -SUH1	NKE Corp.: Fieldbus H System (16 output points)
	Q	EX124 ⁰ -SDN1	DeviceNet (2 power supply systems)
	R1	EX124 ⁰ -SCS1	OMRON Corp.: CompoBus/S (16 output points, 2 power supply systems)
	R2	EX124 ⁰ -SCS2	OMRON Corp.: CompoBus/S (8 output points, 2 power supply systems)
	V	EX124 ⁰ -SMJ1	CC-Link (2 power supply systems)
T (Terminal block box kit)	—	VVQ5000-70A- ⁰ (-W)	—

VQ4000 Series

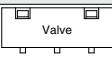
List of Valves, Options, and Mounting Bolts

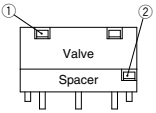
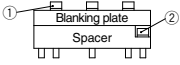
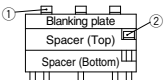
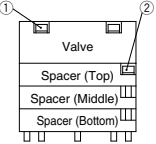
Number of options	Valve and options	Bolt part no.	Qty (pcs.)	Note	Option mounting diagram	
0	Single valve	AXT632-17-4 (M3 x 37)	3			
	Blanking plate (VVQ4000-10A- $\frac{1}{5}$)	AXT632-38-1 (M3 x 14)	4	For manifold		
1	Valve + Individual SUP spacer (VVQ4000-P- $\frac{1}{5}$ $\frac{05}{5}$)	① AXT632-17-10 (M3 x 62) ② AXT632-17-19 (M3 x 26)	3 2	For manifold		
	Valve + Individual EXH spacer (VVQ4000-R- $\frac{1}{5}$ $\frac{05}{5}$)	① AXT632-17-10 (M3 x 62) ② AXT632-17-19 (M3 x 26)	3 2	For manifold		
	Valve + Restrictor spacer (VVQ4000-20A- $\frac{1}{5}$)	① AXT632-17-10 (M3 x 62) ② AXT632-17-19 (M3 x 26)	3 2	Not necessary when mounting the sub-plate.		
	Valve + Release valve spacer (VVQ4000-24A- $\frac{1}{5}$ D)	① AXT632-17-10 (M3 x 62) ② AXT632-17-19 (M3 x 26)	3 2	For manifold		
	Valve + SUP stop valve spacer (VVQ4000-37A- $\frac{1}{5}$)	① AXT632-17-10 (M3 x 62) ② AXT632-17-19 (M3 x 26)	3 2	Not necessary when mounting the sub-plate.		
	Valve + Double check spacer with residual pressure exhaust (VVQ4000-25A- $\frac{1}{5}$)	① AXT632-17-11 (M3 x 87) ② AXT632-41-1 (M3 x 54)	3 2	Not necessary when mounting the sub-plate.		
	Valve + Interface regulator (ARBQ4000-00B- $\frac{1}{5}$)	① AXT632-17-11 (M3 x 87) ② AXT632-17-8 (M3 x 52)	3 2	Not necessary when mounting the sub-plate.		
	Blanking plate + SUP stop valve (Top) (Bottom)	① AXT632-41-4 (M3 x 42) ② AXT632-17-19 (M3 x 26)	3 2	For manifold		
	2	Valve + Individual SUP + Individual EXH (Top) (Bottom) (Bottom) (Top)	① AXT632-17-11 (M3 x 87) ② AXT632-17-8 (M3 x 52)	3 2		For manifold
Valve + Restrictor + Individual SUP or Individual EXH (Top) (Bottom) (Bottom) (Top)		① AXT632-17-11 (M3 x 87) ② AXT632-17-8 (M3 x 52)	3 2	For manifold The individual EXH cannot be mounted on the top.		
Valve + SUP stop valve + Individual SUP, Individual EXH or Restrictor (Top) (Bottom)		① AXT632-17-11 (M3 x 87) ② AXT632-17-8 (M3 x 52)	3 2	For manifold		
Valve + Double check spacer with + Individual SUP or residual pressure exhaust Individual EXH (Top) (Bottom)		① AXT632-17-14 (M3 x 112) ② AXT632-41-2 (M3 x 78)	3 2	For manifold		
Valve + Interface regulator + Individual SUP, Individual EXH or Restrictor (Top) (Bottom)		① AXT632-17-14 (M3 x 112) ② AXT632-41-2 (M3 x 78)	3 2	For manifold The individual EXH and restrictor can be mounted on the top.		
Valve + Restrictor + Double check spacer with residual pressure exhaust (Top) (Bottom)		① AXT632-17-14 (M3 x 112) ② AXT632-41-2 (M3 x 78)	3 2	For manifold		
Valve + Double check spacer with + Interface regulator residual pressure exhaust (Bottom) (Top)		① AXT632-17-16 (M3 x 137) ② AXT632-41-3 (M3 x 103)	3 2	For manifold		
Blanking plate + SUP stop valve + Individual SUP (Top) (Bottom)		① AXT632-17-17 (M3 x 66) ② AXT632-17-8 (M3 x 52)	3 2	For manifold		
3		Valve + SUP stop valve (Top) + Individual SUP (Middle, Bottom) + Individual EXH (Middle, Bottom)	① AXT632-17-14 (M3 x 112) ② AXT632-17-13 (M3 x 77)	3 2	For manifold	
	Valve + Double check spacer with residual pressure exhaust (Top) + Individual SUP (Middle, Bottom) + Individual EXH (Middle, Bottom)	① AXT632-17-16 (M3 x 137) ② AXT632-41-3 (M3 x 103)	3 2	For manifold		
	Valve + Spacer (Top); Interface regulator (Middle); Individual SUP or Individual EXH/Restrictor (Bottom); Restrictor/Individual SUP or Individual EXH	① AXT632-17-16 (M3 x 137) ② AXT632-41-3 (M3 x 103)	3 2	For manifold The individual EXH and restrictor can be mounted on the top.		
	Valve + Double check spacer with residual pressure exhaust (Top) + SUP stop valve (Middle) + Individual SUP (EXH) (Bottom)	① AXT632-17-16 (M3 x 137) ② AXT632-41-3 (M3 x 103)	3 2	For manifold		
	Valve + Interface regulator (TOP) + Double check spacer with residual pressure exhaust (Middle) + Individual SUP (EXH) (Bottom)	① AXT632-17-20 (M3 x 162) ② AXT632-41-5 (M3 x 128)	3 2	For manifold available as special order		

Note 1) When the SUP stop valve and individual SUP are mounted, the stop valve is mounted on the top of the individual SUP.

SV
SYJ
SZ
VF
VP4
VQ 1/2
VQ 4/5
VQC 1/2
VQC 4/5
VQZ
SQ
VFS
VFR
VQ7

Base Mounted

Plug-in/Plug Lead: Single Unit

VQ5000 Series



[Option]
Note) CE-compliant:
For DC only.

Model

Series	Configuration	Model	Port size	Flow rate characteristics						Response time [ms]			Weight [kg]	
				1 → 4/2 (P → A/B)			4/2 → 5/3 (A/B → EA/EB)			Standard: 0.95 W	Low wattage type: 0.4 W	AC		
				C [dm ³ (s-bar)]	b	Cv	C [dm ³ (s-bar)]	b	Cv					
VQ5000	2-position	Single	Metal seal	VQ51 ₅ 0	12	0.14	2.9	14	0.18	3.4	35	38	38	0.59 (0.67)
			Rubber seal	VQ51 ₉ 1	16	0.33	4.4	17	0.31	4.7	40	43	48	0.58 (0.66)
		Double	Metal seal	VQ52 ₅ 0	12	0.14	2.9	14	0.18	3.4	20	23	23	0.62 (0.70)
			Rubber seal	VQ52 ₉ 1	16	0.33	4.4	17	0.31	4.7	25	28	28	0.60 (0.68)
	3-position	Closed center	Metal seal	VQ53 ₅ 0	11	0.24	2.6	11	0.23	2.8	50	53	70	0.65 (0.73)
			Rubber seal	VQ53 ₉ 1	12	0.33	3.4	13	0.37	3.7	60	63	63	0.58 (0.66)
		Exhaust center	Metal seal	VQ54 ₅ 0	12	0.13	2.9	14	0.18	3.4	50	53	70	0.65 (0.73)
			Rubber seal	VQ54 ₉ 1	14	0.39	3.9	16	0.35	4.5	60	63	63	0.58 (0.66)
		Pressure center	Metal seal	VQ55 ₅ 0	12	0.23	2.9	13	0.24	3.3	50	53	70	0.65 (0.73)
			Rubber seal	VQ55 ₉ 1	13	0.32	3.4	14	0.40	3.9	60	63	63	0.58 (0.66)
		Double check	Metal seal	VQ56 ₅ 0	8.0	—	—	8.5	—	—	62	65	65	1.17 (1.25)
			Rubber seal	VQ56 ₉ 1	8.3	—	—	9.0	—	—	75	78	78	1.10 (1.18)

Note 1) Value for valve on sub-plate.

Note 2) Cylinder port 1/2: Value for valve on sub-plate.

Note 3) Based on JIS B 8419: 2010. (Supply pressure: 0.5 MPa, with indicator light and surge voltage suppressor, clean air.

This will change depending on pressure and air quality.) The value when ON for the double type.

Note 4) Values inside () indicate the weight of plug lead units.

Table: Without sub-plate, With sub-plate; Add 0.65 kg for plug-in type, 0.55 kg for plug lead type.

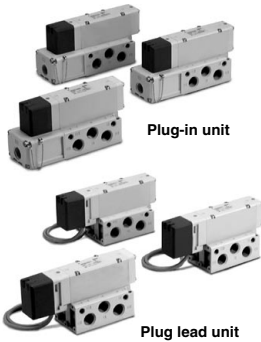

Plug-in unit

Plug lead unit

Symbol

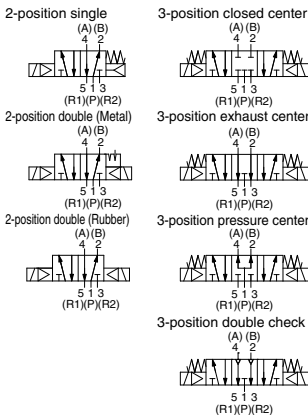

Standard Specifications

Valve specifications	Valve construction	Metal seal	Rubber seal
	Fluid	Air/Inert gas	
Max. operating pressure	1.0 MPa		
Min. operating pressure	Single	0.10 MPa	0.20 MPa
	Double	0.10 MPa	0.15 MPa
	3-position	0.15 MPa	0.20 MPa
Ambient and fluid temperature	-10 to 50°C Note 1)		
Lubrication	Not required		
Manual override	Push type/Locking type (Tool required)		
Impact/Vibration resistance	150/30 m/s ² Note 2)		
Enclosure	Dust-tight (IP65 compatible) Note 3)		
Coil rated voltage	12, 24 VDC, 100, 110, 200, 220 VAC (50/60 Hz)		
Allowable voltage fluctuation	±10% of rated voltage		
Coil insulation type	Class B or equivalent		
Power consumption [W]	DC	Standard	0.95
		Low wattage type	0.4
	AC	100 V	1.19
		110 V	1.32
Apparent power [VA]	200 V	1.90	
	220 V	2.08	

Note 1) Use dry air to prevent condensation when operating at low temperatures.

Note 2) Impact resistance: No malfunction occurred when it is tested with a drop tester in the axial direction and at the right angles to the main valve and armature in both energized and de-energized states every once for each condition. (Values at the initial period)

Vibration resistance: No malfunction occurred in a one-sweep test between 45 and 2000 Hz. Test was performed at both energized and de-energized states in the axial direction and at the right angles to the main valve and armature. (Values at the initial period)

Note 3) Available only with T, L, S and C.



How to Order Valves (Single Unit)

Body

0: Plug-in sub-plate

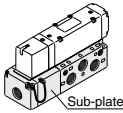

Sub-plate

Port size

Nil	Without sub-plate (For manifold)
04	1/2

Thread type

Nil	Rc
F	G
N	NPT
T	NPTF

Enclosure

Nil	Dust-protected
W	Dust-tight/Water-jet-proof (IP65)

CE-compliant

Nil	—
Q	CE-compliant

Note) CE-compliant: For DC only.

Porting specifications

Nil	Side ported
B	Bottom ported

Type of actuation

1	2-position single (A)(B) 4 2 5 1 3 (R1)(P)(R2)
2	2-position double (A)(B) 4 2 5 1 3 (R1)(P)(R2)
3	3-position closed center (A)(B) 4 2 5 1 3 (R1)(P)(R2)
4	3-position exhaust center (A)(B) 4 2 5 1 3 (R1)(P)(R2)
5	3-position pressure center (A)(B) 4 2 5 1 3 (R1)(P)(R2)
6	3-position double check (A)(B) 4 2 5 1 3 (R1)(P)(R2)

Note) For details about double check type, refer to page 524.

Manual override

Nil:	Non-locking push type (Tool required)
B:	Locking type (Tool required)
C:	Locking type (Manual)

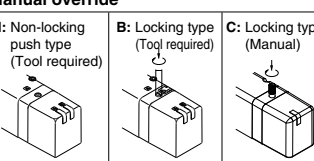

Light/Surge voltage suppressor

Nil	Yes
E	Without light, with surge voltage suppressor

Coil voltage

1	100 VAC (50/60 Hz)
2	200 VAC (50/60 Hz)
3	110 VAC (50/60 Hz)
4	220 VAC (50/60 Hz)
5	24 VDC
6	12 VDC

Electrical entry

G	Lead wire length 0.6 m
	H
H	Lead wire length 1.5 m

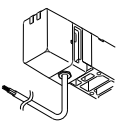

Seal

0	Metal seal
1	Rubber seal

Function

Nij	Note 1)	Standard (0.95 W)
Y	Note 2)	Low wattage type (0.4 W)
R	Note 3)	External pilot

Note 1) When the unit is energized continuously, refer to "Specific Product Precautions 1" on page 533

Note 2) In addition, only DC is available with Y.

Note 3) For details about external pilot specifications, refer to page 527.

Note 4) When multiple symbols are specified, indicate them alphabetically.

Body

5: Plug lead sub-plate

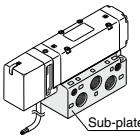

Sub-plate

How to Order Sub-plates

VQ5000 - P [] - [] **04** [] - []

Electrical entry

P	Plug-in conduit terminal
S	Plug lead

Thread type

Nil	Rc
F	G
N	NPT
T	NPTF

CE-compliant

Nil	—
Q	CE-compliant

Enclosure

Nil	Dust-protected
W	Dust-tight/Water-jet-proof

Note) Not required for plug lead type.

Porting specifications

Nil	Side ported
B	Bottom ported

Port size

04	1/2
----	-----

Note) For bottom ported, port size is 1/2.

Replacement of pilot valve assembly (Voltage)

Refer to pages 528 and 529 for pilot valve assembly part numbers.

Refer to page 534 for replacement method.

VQ5000 Series

Dimensions: Plug-in Type

Conduit terminal

2-position single: VQ510⁰

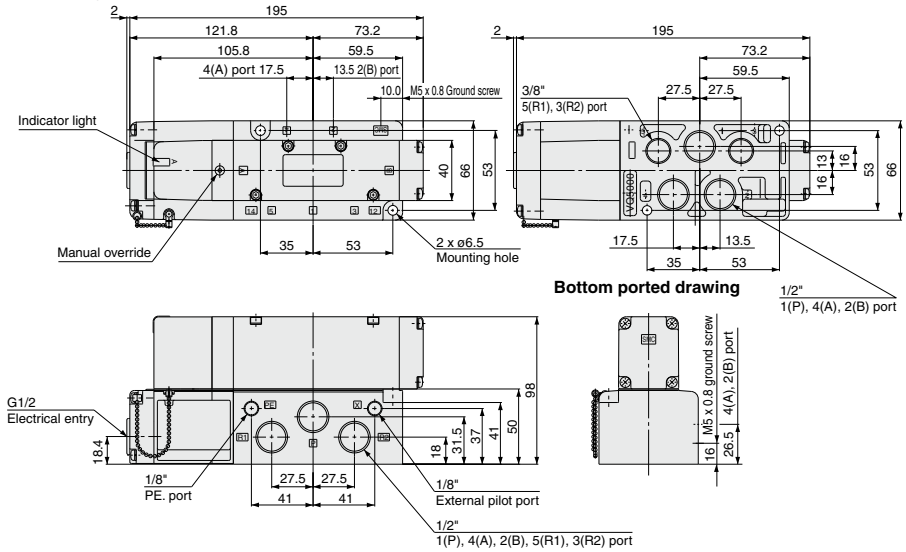

2-position double: VQ520⁰

3-position closed center: VQ530⁰

3-position exhaust center: VQ540⁰

3-position pressure center: VQ550⁰

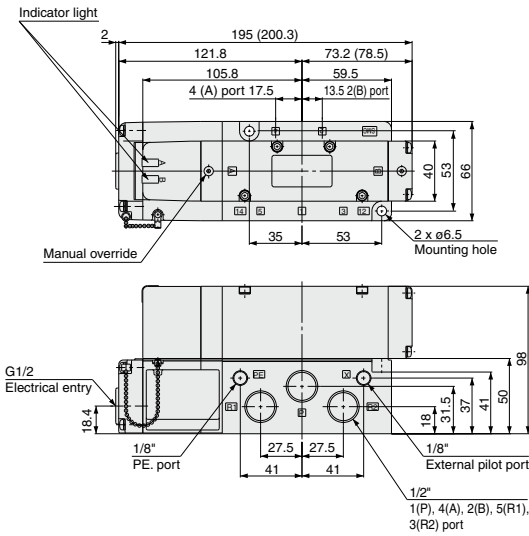

Numbers inside () are for metal seal 3-position type.

3-position double check: VQ560⁰

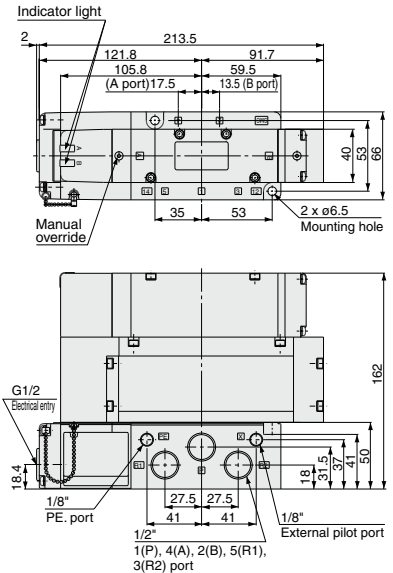

Dimensions: Plug Lead Type

Grommet

2-position single: VQ515⁰-□^G_H

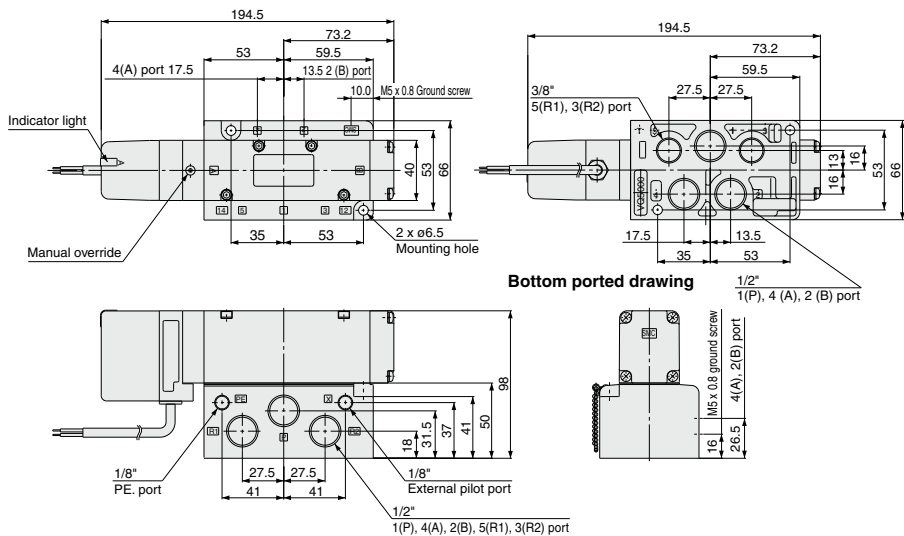

SV
SYJ
SZ
VF
VP4
VQ 1/2
VQ 4/5
VQC 1/2
VQC 4/5
VQZ
SQ
VFS
VFR
VQ7

- 2-position double: VQ525⁰-□^G_H**
- 3-position closed center: VQ535⁰-□^G_H**
- 3-position exhaust center: VQ545⁰-□^G_H**
- 3-position pressure center: VQ555⁰-□^G_H**

3-position double check: VQ565⁰-□^G_H

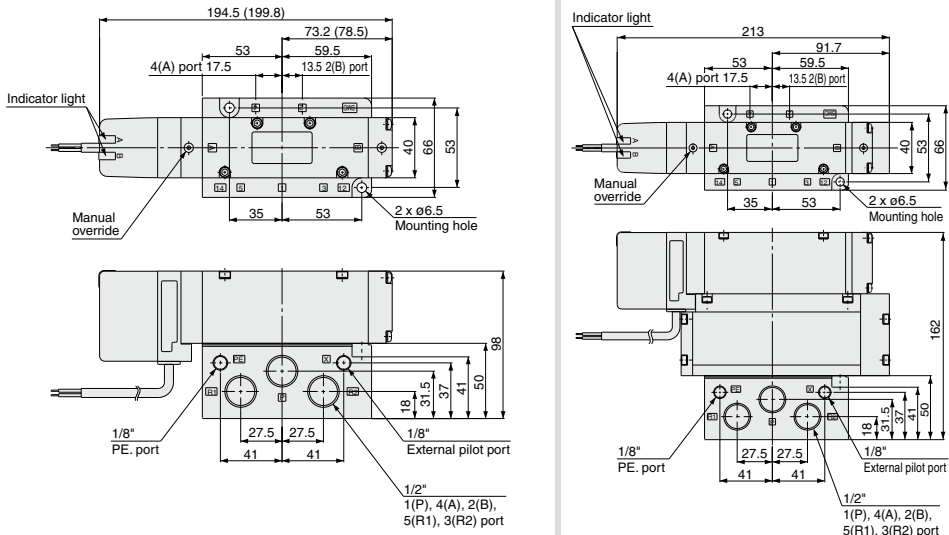

Numbers inside () are for metal seal 3-position type.

Base Mounted

Plug-in Unit

VQ5000 Series



[Option]
Note) CE-compliant:
For DC only.



How to Order Manifold

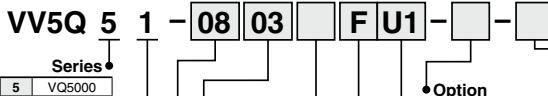

Series

5	VQ5000
---	--------

Manifold

1	Plug-in unit
---	--------------

Station

01	1 station
⋮	⋮

Minimum number of stations depends on the kit.
(Refer to the table below.)

Cylinder port

03	3/8
04	1/2
B	Bottom ported 1/2
CM	Mixed (Note)

Note) In case of mixed specification, indicate on the manifold specification sheet.

Thread type

Nil	Rc
F	G
N	NPT
T	NPTF

Kit type

Option

Symbol	Option
Nil	None
CD1 (Note 2)	Exhaust cleaner for Rc 1: D side exhaust
CD2 (Note 2)	Exhaust cleaner for Rc 1 1/2: D side exhaust
CU1 (Note 2)	Exhaust cleaner for Rc 1: U side exhaust
CU2 (Note 2)	Exhaust cleaner for Rc 1 1/2: U side exhaust
K (Note 4)	Special wiring specifications (Except double wiring)
N	Name plate (T kit only)
SB (Note 3)	Direct exhaust with silencer box: Exhaust from both D and U sides
SD (Note 2)	Direct exhaust with silencer box: D side exhaust
SU (Note 2)	Direct exhaust with silencer box: U side exhaust
W	IP65 enclosure (Except F and T1 kits)

Option

Nil	—
Q	CE-compliant

Note 1) When multiple symbols are specified, indicate them alphabetically.

Example) -CD1K

Note 2) Combination of [C] and [S] is not possible. Also, exhaust cleaner is not attached. Please order it separately.

Note 3) Available only with F, L and T1 kits.

Note 4) Specify the wiring specifications on the manifold specification sheet. (Except L kit)

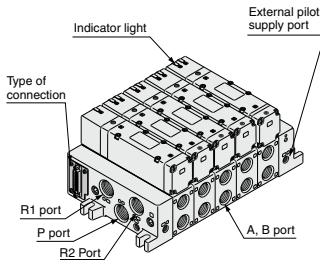

Note) Figure shows VV5Q51-0504FD0.

Kit/Electrical entry/Cable length

F Kit (D-sub connector)

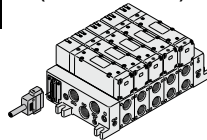

Connector entry direction		Without cable	1 to 12 stations
D side	U side		
F Kit	F Kit	U1 Cable length 1.5 m	
	D2 Kit	U2 Cable length 3 m	
	D3 Kit	U3 Cable length 5 m	

L Kit (Lead wire cable)

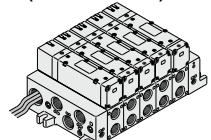

Connector entry direction		IP65 compatible	1 to 12 stations
D side	U side		
L Kit	L Kit	U0 Cable length 0.6 m	
	D1 Kit	U1 Cable length 1.5 m	
	D2 Kit	U2 Cable length 3 m	

T Kit (Terminal block box kit)

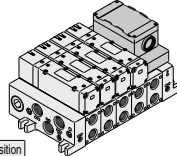

Box mounting position		IP65 compatible
D side	U side	
TD	TU	Terminal block box 2 to 12 stations (Note)

T1 Kit (Individual terminal block kit)

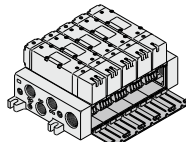

Unit mounting position		IP65 compatible	CE compliant
D side	U side		
SD	0	Without SI Unit	●
	H	NKE Corp.: Fieldbus H System	—
	Q	DeviceNet	●
	R1	OMRON Corp.: CompoBus/S (16 output points)	●
	R2	OMRON Corp.: CompoBus/S (8 output points)	●
	V	CC-LINK System	●

S Kit (Serial transmission unit)

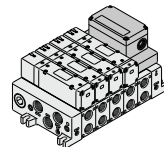

The valve voltage is 24 VDC and it is equipped with light/surge voltage suppressor.

Unit mounting position		IP65 compatible	CE compliant
D side	U side		
SD	0	Without SI Unit	●
	H	NKE Corp.: Fieldbus H System	—
	Q	DeviceNet	●
	R1	OMRON Corp.: CompoBus/S (16 output points)	●
	R2	OMRON Corp.: CompoBus/S (8 output points)	●
	V	CC-LINK System	●

Note) For the T kit and S kit, one station is required to mount the terminal block box or SI Unit, so the minimum number of stations is 2 stations.

Manifold Specifications

Series	Base model	Type of connection	Porting specifications		Maximum applicable stations	Applicable valve	Weight [kg] (Formula)	
			4(A), 2(B) port location	Port size				
				1(P), 5(R1), 3(R2)				4(A), 2(B)
VQ5000	VV5Q51-□□□	<ul style="list-style-type: none"> ■ F kit-D-sub connector ■ T kit-Terminal block box ■ T1 kit-Individual terminal block kit ■ L kit-Lead wire ■ S kit-Serial transmission 	Side	3/4 Option { Direct exhaust with silencer box }	3/8 1/2	F, L, T1 kits 12 stations T kit 12 stations S kit 12 stations	VQ5□00 VQ5□01	F, L kit: 0.62n + 1.4 S, T kit: 0.62(n-1) + 2.6 • Not including valve weight.
			Bottom					

n: Stations

Flow Rate Characteristics at the Number of Manifold Stations (Operated individually)

Model	Passage/Stations	Station 1	Station 5	Station 10	
2-position metal seal VQ5 ₂ 00	1 → 4/2 (P → A/B)	C [dm ³ /(s-bar)]	11	11	11
		b	0.24	0.24	0.24
		Cv	2.7	2.7	2.7
	4/2 → 5/3 (A/B → EA/EB)	C [dm ³ /(s-bar)]	12	12	12
		b	0.14	0.14	0.14
		Cv	2.9	2.9	2.9
2-position rubber seal VQ5 ₂ 01	1 → 4/2 (P → A/B)	C [dm ³ /(s-bar)]	12	12	12
		b	0.33	0.33	0.33
		Cv	3.4	3.4	3.4
	4/2 → 5/3 (A/B → EA/EB)	C [dm ³ /(s-bar)]	16	16	16
		b	0.33	0.33	0.33
		Cv	4.4	4.4	4.4

(Note) For port size 1/2

Manifold Options

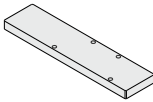
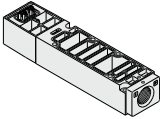
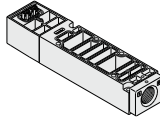
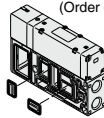
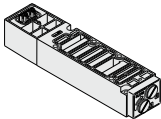
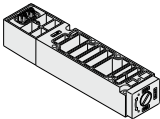
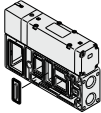
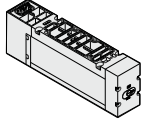
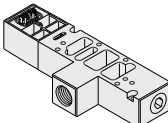
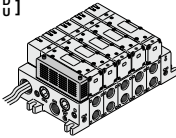
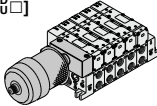
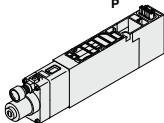
Blanking plate assembly VVQ5000-10A-1 	Individual SUP spacer VVQ5000-P-1-⁰³/₀₄ 	Individual EXH spacer VVQ5000-R-1-⁰³/₀₄ 	EXH block plate VVQ5000-16A-2 (1 pc./set) (Order q'ty: 2 pcs.) 
Restrictor spacer VVQ5000-20A-1 	SUP stop valve spacer VVQ5000-37A-1 	SUP block plate VVQ5000-16A-1 	Double check spacer with residual pressure exhaust VVQ5000-25A-1 
Release valve spacer: For D side mounting VVQ5000-24A-1D 	Direct exhaust with silencer box [-S₀□] 	Manifold mounted exhaust cleaner [-C₀□] 	Interface regulator (P, A, B port regulation) ARBQ5000-00-^A/_B-1 

• Refer to pages 522 to 526 for detailed dimensions of each option.
 • For replacement parts, refer to page 531.

SV

SYJ

SZ

VF

VP4

VQ 1/2

VQ 4/5

VQC 1/2

VQC 4/5

VQZ

SQ

VFS

VFR

VQ7

VQ5000 Series

F Kit (D-sub connector kit)

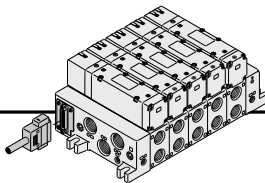

- Simplification and labor savings for wiring work can be achieved by using a D-sub connector for the electrical connection.
- Using connector for flat ribbon cable (25P) conforming to MIL standard permits the use of connectors put on the market and gives a wide interchangeability.
- Connector entry can be selected on either the U side or the D side according to the mounting orientation.
- Maximum stations are 12.

Manifold Specifications

Series	Porting specifications			Applicable stations
	4(A), 2(B) port location	Port size		
VQ5000	Side	3/4	4(A), 2(B)	Max. 12 stations
	Bottom		3/8	

D-Sub Connector Kit (25 pins)

Cable assembly

AXT100-DS25-015
030
050

(D-sub connector cable assemblies can be ordered with manifolds.)
(Refer to How to Order Manifold.)

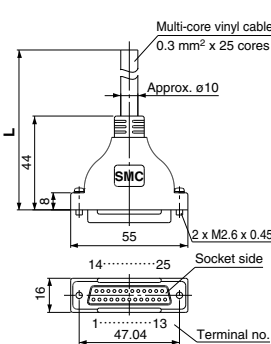

D-sub Connector Cable Assembly

Cable length [L]	Assembly part no.	Note
1.5 m	AXT100-DS25-015	Cable 0.3 mm² x 25 cores
3 m	AXT100-DS25-030	
5 m	AXT100-DS25-050	

- For other commercial connectors, use a 25-pin type female connector conforming to MIL-C-24308.
- Cannot be used for transfer wiring.

Connector Manufacturers Example

- Fujitsu, Limited
- Japan Aviation Electronics Industry, Limited
- J.S.T. Mfg. Co., Ltd.
- HIROSE ELECTRIC CO., LTD.

Electric Characteristics

Item	Characteristics
Conductor resistance Ω/km, 20°C	65 or less
Voltage limit VAC, 1 min.	1000
Insulation resistance MΩ/km, 20°C	5 or more

(Note) The minimum bending radius for D-sub connector cables is 20 mm.

D-sub Connector Cable Assembly Terminal No.

Terminal no.	Lead wire color	Dot marking
1	Black	None
2	Brown	None
3	Red	None
4	Orange	None
5	Yellow	None
6	Pink	None
7	Blue	None
8	Purple	White
9	Gray	Black
10	White	Black
11	White	Red
12	Yellow	Red
13	Orange	Red
14	Yellow	Black
15	Pink	Black
16	Blue	White
17	Purple	None
18	Gray	None
19	Orange	Black
20	Red	White
21	Brown	White
22	Pink	Red
23	Gray	Red
24	Black	White
25	White	None

(Note) Lengths other than the above are also available. Please contact SMC for details.

How to Order Manifold

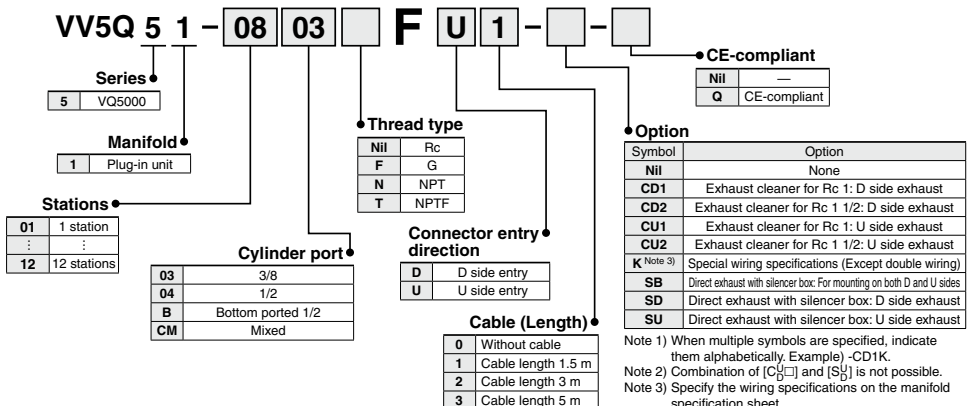

● **Electrical wiring specifications**

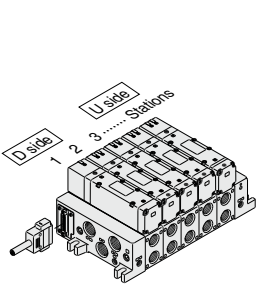

Stations are counted starting from the first station on the D side.

D-sub connector

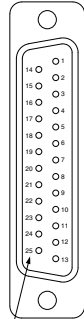

Double wiring (connected to SOL. A and SOL. B) is adopted for the internal wiring of each station, regardless of valve and option types. Mixed single and double wiring is available as a semi-standard specification. For details, refer to below.

Standard wiring

Terminal no.	Polarity	Lead wire color	Dot marking
1 station { SOL.A - 1	(-)	(+) Black	None
SOL.B - 14	(-)	(+) Yellow	Black
2 stations { SOL.A - 2	(-)	(+) Brown	None
SOL.B - 15	(-)	(+) Pink	Black
3 stations { SOL.A - 3	(-)	(+) Red	None
SOL.B - 16	(-)	(+) Blue	White
4 stations { SOL.A - 4	(-)	(+) Orange	None
SOL.B - 17	(-)	(+) Purple	None
5 stations { SOL.A - 5	(-)	(+) Yellow	None
SOL.B - 18	(-)	(+) Gray	None
6 stations { SOL.A - 6	(-)	(+) Pink	None
SOL.B - 19	(-)	(+) Orange	Black
7 stations { SOL.A - 7	(-)	(+) Blue	None
SOL.B - 20	(-)	(+) Red	White
8 stations { SOL.A - 8	(-)	(+) Purple	White
SOL.B - 21	(-)	(+) Brown	White
9 stations { SOL.A - 9	(-)	(+) Gray	Black
SOL.B - 22	(-)	(+) Pink	Red
10 stations { SOL.A - 10	(-)	(+) White	Black
SOL.B - 23	(-)	(+) Gray	Red
11 stations { SOL.A - 11	(-)	(+) White	Red
SOL.B - 24	(-)	(+) Black	White
12 stations { SOL.A - 12	(-)	(+) Yellow	Red
SOL.B - 25	(-)	(+) White	None
COM. - 13	(+)	(-) (Note) Orange	Red

D-sub connector assembly (AXT100-DS25-015/050) Wire colors

Special Wiring Specifications

Double wiring (connected to SOL. A and SOL. B) is used for the internal wiring of each station regardless of valve and option types. Mixed single and double wiring is available as a semi-standard specification.

1. How to Order

Indicate option symbol "K" in the manifold part number and be sure to specify station positions for single or double wiring on the manifold specification sheet.

2. Wiring specifications

Connections begin with the A side solenoid of the first station being connected to terminal no. 1, and continue in the order indicated by the arrows in the drawing without skipping any terminals. However, the maximum number of stations is 12.

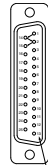

D-sub connector

How to Order Valves

VQ 5 1 0 0 - 5 1 -

Type of actuation	
1	2-position single
2	2-position double
3	3-position closed center
4	3-position exhaust center
5	3-position pressure center
6	3-position double check

Manual override	
Nil	Non-locking push type (Tool required)
B	Locking type (Tool required)
C	Locking type (Manual)

Light/Surge voltage suppressor	
Nil	Yes
E	Without light, with surge voltage suppressor

Coil voltage	
1	100 VAC (50/60 Hz)
2	200 VAC (50/60 Hz)
3	110 VAC (50/60 Hz)
4	220 VAC (50/60 Hz)
5	24 VDC
6	12 VDC

CE-compliant	
Nil	—
Q	CE-compliant

Note) CE-compliant: For DC only.

Seal	
0	Metal seal
1	Rubber seal

Function	
Nij (Note 1)	Standard (0.95 W)
Y (Note 2)	Low wattage type (0.4 W)
R (Note 3)	External pilot

Note 1) When the unit is energized continuously, refer to "Specific Product Precautions 1" on page 533.
 Note 2) In addition, only DC is available with Y.
 Note 3) For details about external pilot specifications, refer to page 527.
 Note 4) When multiple symbols are specified, indicate them alphabetically.

How to Order Manifold Assembly

Specify the part numbers for valves and options together beneath the manifold base part number.

<Example>
 D-sub connector kit with cable (3 m)
 VV5Q51-0503FD2(-Q)-1 set—Manifold base part no.
 *VQ5100-51(-Q).....2 sets—Valve part no. (Stations 1 and 2)
 *VQ5200-51(-Q).....2 sets—Valve part no. (Stations 3 and 4)
 *VQ5300-51(-Q).....1 set—Valve part no. (Station 5)

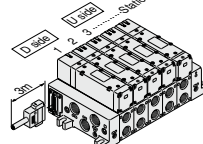
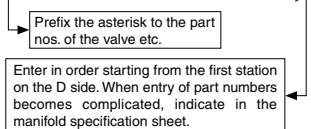

- SV
- SYJ
- SZ
- VF
- VP4
- VQ 1/2
- VQ 4/5
- VQC 1/2
- VQC 4/5
- VQZ
- SQ
- VFS
- VFR
- VQ7

VQ5000 Series

F

Kit (D-sub connector kit)

Applicable connector: D-sub connector (25P)
(Conforming to MIL-C-24308)

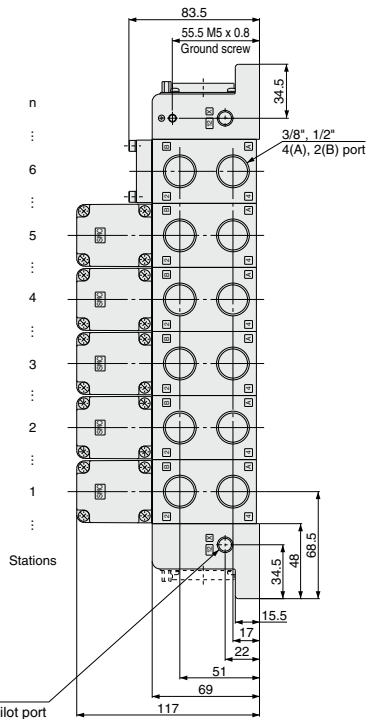
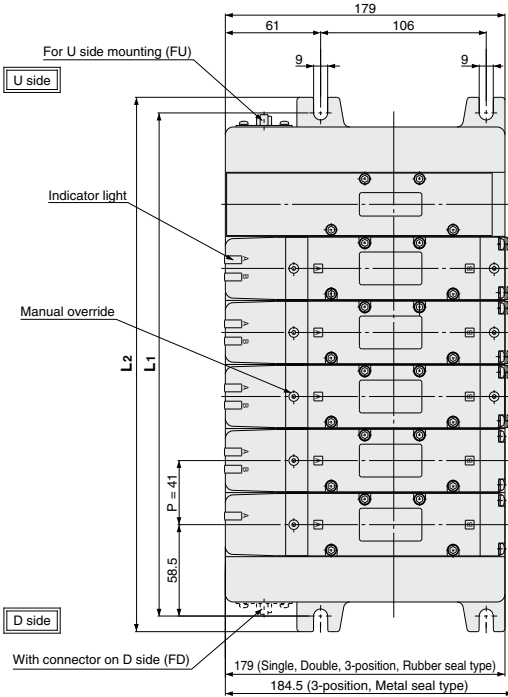
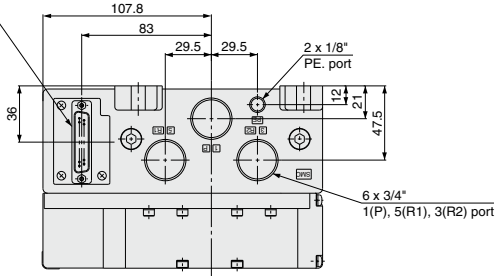

Bottom ported drawing

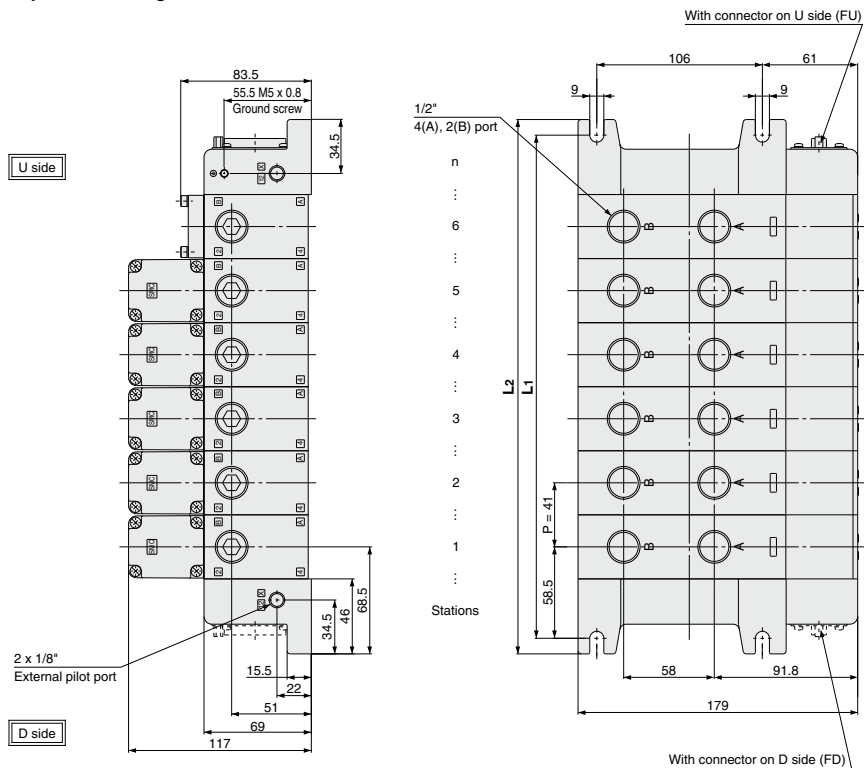

- SV
- SYJ
- SZ
- VF
- VP4
- VQ 1/2
- VQ 4/5**
- VQC 1/2
- VQC 4/5
- VQZ
- SQ
- VFS
- VFR
- VQ7

Dimensions Formula: $L_1 = 41n + 76$, $L_2 = 41n + 96$ n: Stations (Maximum 12 stations)

L	n	1	2	3	4	5	6	7	8	9	10	11	12
L ₁		117	158	199	240	281	322	363	404	445	486	527	568
L ₂		137	178	219	260	301	342	383	424	465	506	547	588

VQ5000 Series

T

Kit (Terminal block box kit)

IP65 compliant

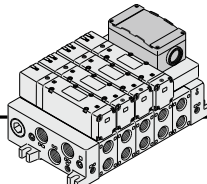

- Enclosure IP65 compliant
- This type has a small terminal block inside a junction box. The provision of a G3/4 electrical entry allows connection of conduit fittings.
- Maximum stations are 11. (12 stations as a semi-standard specification)
- 1 station is used for terminal block box mounting.

Manifold Specifications

Series	Porting specifications			Applicable stations
	4(A), 2(B) port location	Port size		
VQ5000		Side	3/4	4(A), 2(B)
	Bottom	3/8 1/2		

Terminal Block Connections

Step 1. How to remove terminal block cover

Loosen the 4 mounting screws (M4) and open the terminal block cover.

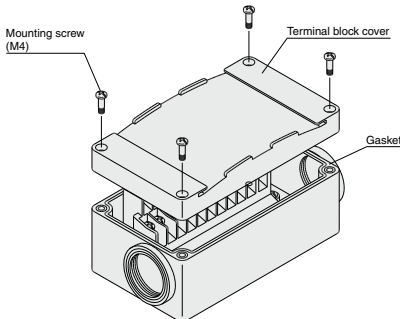

Step 2. The diagram on the right shows the terminal block wiring.

All stations are provided with double wiring regardless of the valves which are mounted.

Connect each wire to the power supply side, according to the markings provided inside the terminal block.

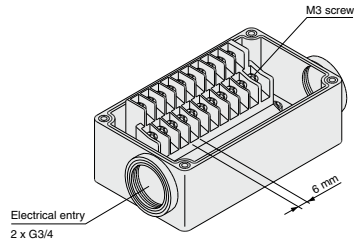

Step 3. How to attach the terminal block cover

Securely tighten the screws with the torque shown in the table below, after confirming that the gasket is installed correctly.

Proper tightening torque [N·m]
0.7 to 1.2

- Applicable terminal: 1.25-3S, 1.25Y-3, 1.25Y-3N, 1.25Y-3.5
- Name plate: VVQ5000-N-T
- Dripproof plug assembly (for G3/4): AXT100-B06A



How to Order Manifold

VV5Q 5 1 - 08 03 [] T [] - [] - []

Series
5 VQ5000

Manifold
1 Plug-in unit

Stations

02	2 stations
...	...
12	12 stations

Cylinder port

03	3/8
04	1/2
B	Bottom ported 1/2
CM	Mixed

Box mounting position

D	D side mounting
U	U side mounting

Thread type

Nil	Rc
F	G
N	NPT
T	NPTF

CE-compliant

Nil	—
Q	CE-compliant

Option

Symbol	Option
Nil	None
CD1	Exhaust cleaner for Rc 1: D side exhaust
CD2	Exhaust cleaner for Rc 1 1/2: D side exhaust
CU1	Exhaust cleaner for Rc 1: U side exhaust
CU2	Exhaust cleaner for Rc 1 1/2: U side exhaust
K	Special wiring specifications (Except double wiring, 12 stations)
N	Name plate
SD	Direct exhaust with silencer box: D side exhaust
SU	Direct exhaust with silencer box: U side exhaust
W	IP65 enclosure

Note) One station is used for mounting the terminal block box. The number of stations is the number of manifold valves plus one station for the terminal block box. For 12 stations, specify the wiring specifications by means of the manifold specification sheet.

Note 1) When multiple symbols are specified, indicate them alphabetically.
Example) -CD1K
Note 2) Combination of [C] and [S] is not possible.
Note 3) Specify the wiring specifications on the manifold specification sheet.

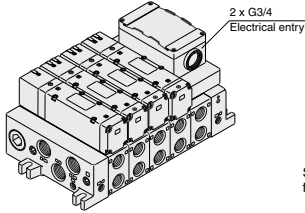

Stations are counted starting from the first station on the D side.

● **Electrical wiring specifications (IP65 available)**

	Terminal no.	Polarity
1 station	SOL_A_01A	(-) (+)
	SOL_B_01B	(-) (+)
2 stations	SOL_A_02A	(-) (+)
	SOL_B_02B	(-) (+)
3 stations	SOL_A_03A	(-) (+)
	SOL_B_03B	(-) (+)
4 stations	SOL_A_04A	(-) (+)
	SOL_B_04B	(-) (+)
5 stations	SOL_A_05A	(-) (+)
	SOL_B_05B	(-) (+)
6 stations	SOL_A_06A	(-) (+)
	SOL_B_06B	(-) (+)
7 stations	SOL_A_07A	(-) (+)
	SOL_B_07B	(-) (+)
8 stations	SOL_A_08A	(-) (+)
	SOL_B_08B	(-) (+)
9 stations	SOL_A_09A	(-) (+)
	SOL_B_09B	(-) (+)
10 stations	SOL_A_010A	(-) (+)
	SOL_B_010B	(-) (+)
	SOL_A_COM	(+) (-)

Double wiring (connected to SOL. A and SOL. B) is adopted for the internal wiring of each station, regardless of valve and option types. Mixed single and double wiring is available as a semi-standard specification.

Special Wiring Specifications

Double wiring (connected to SOL. A and SOL. B) is used for the internal wiring of each station regardless of valve and option types. The optional specification permits mixture of single and double wiring. However, the maximum number of stations is 12.

1. How to Order

Indicate option symbol ("K") in the manifold part number and be sure to specify station positions for single or double wiring on the manifold specification sheet.

2. Wiring specifications

Connections begin with the A side solenoid of the first station being connected to terminal no. 1, and continue in the order indicated by the arrows in the drawing without skipping any terminals.

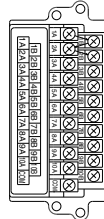

How to Order Valves



VQ 5 1 0 0 - 5 1 -

Type of actuation

1	2-position single
2	2-position double
3	3-position closed center
4	3-position exhaust center
5	3-position pressure center
6	3-position double check

Seal

0	Metal seal
1	Rubber seal

Series

5	VQ5000
---	--------

Function

NII	Standard (0.95 W)
Y	Low wattage type (0.4 W)
R	External pilot

CE-compliant

NII	—
Q	CE-compliant

(Note) CE-compliant: For DC only.

Enclosure

NII	Dust-protected
W	Dust-tight/ Water-jet-proof (IP65)

Manual override

NII	Non-locking push type (Tool required)
B	Locking type (Tool required)
C	Locking type (Manual)

Light/Surge voltage suppressor

NII	Yes
E	Without light, with surge voltage suppressor

Note 1) When the unit is energized continuously, refer to "Specific Product Precautions 1" on page 533.
 Note 2) In addition, only DC is available with Y.
 Note 3) For details about external pilot specifications, refer to page 527.
 Note 4) When multiple symbols are specified, indicate them alphabetically.

Coil voltage

1	100 VAC (50/60 Hz)
2	200 VAC (50/60 Hz)
3	110 VAC (50/60 Hz)
4	220 VAC (50/60 Hz)
5	24 VDC
6	12 VDC

How to Order Manifold Assembly

Specify the part numbers for valves and options together beneath the manifold base part number.

<Example>

- Terminal block box kit
 VV5Q51-0603TU(-Q)-1 set—Manifold base part no.
 *VQ5100-51(-Q)-2 sets—Valve part no. (Stations 1 and 2)
 *VQ5200-51(-Q)-2 sets—Valve part no. (Stations 3 and 4)
 *VQ5300-51(-Q)-1 set—Valve part no. (Station 5)

Prefix the asterisk to the part nos. of the valve etc.

Enter in order starting from the first station on the D side. When entry of part numbers becomes complicated, indicate in the manifold specification sheet.

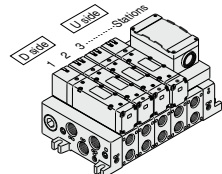

SV
SYJ
SZ
VF
VP4
VQ 1/2
VQ 4/5
VQC 1/2
VQC 4/5
VQZ
SQ
VFS
VFR
VQ7

VQ5000 Series

T

Kit (Terminal block box kit)

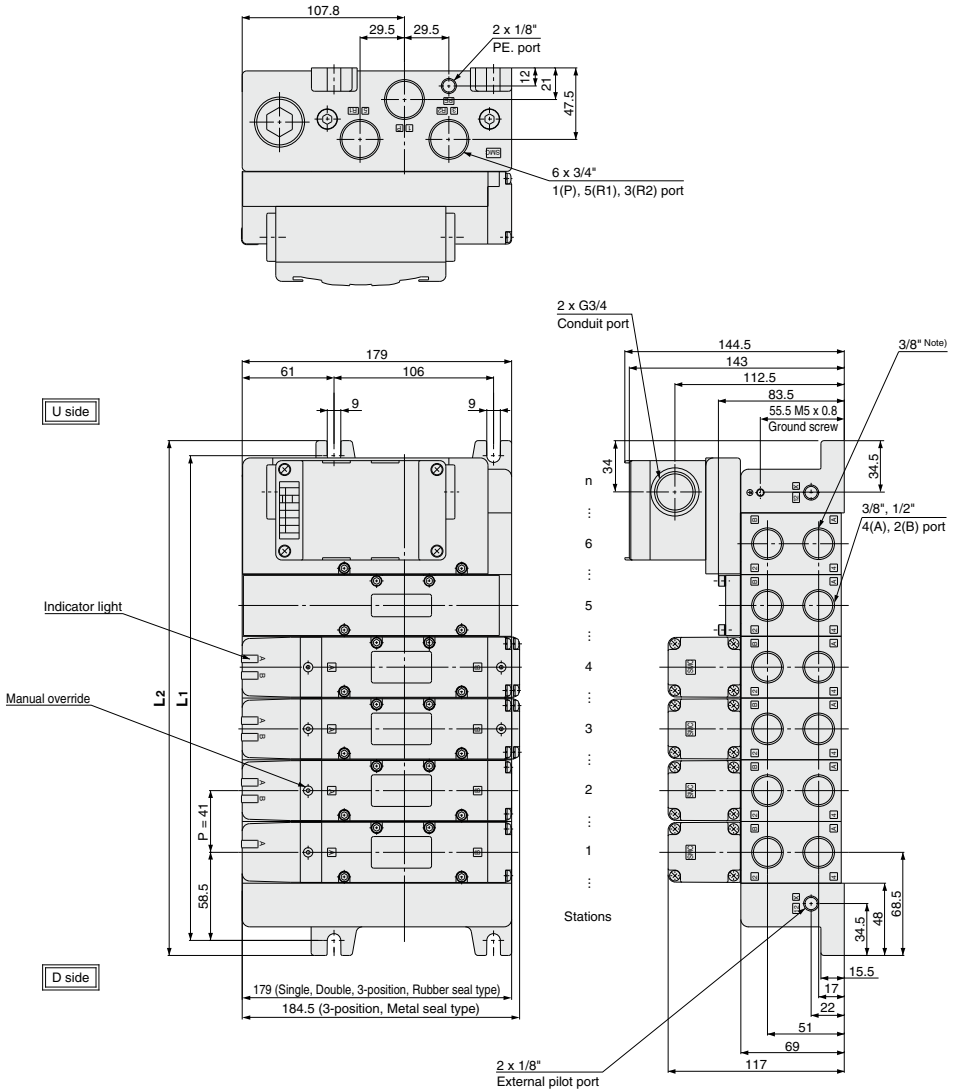

Note) 4(A) and 2(B) port at the bottom of the terminal block box are 3/8".

Bottom ported drawing

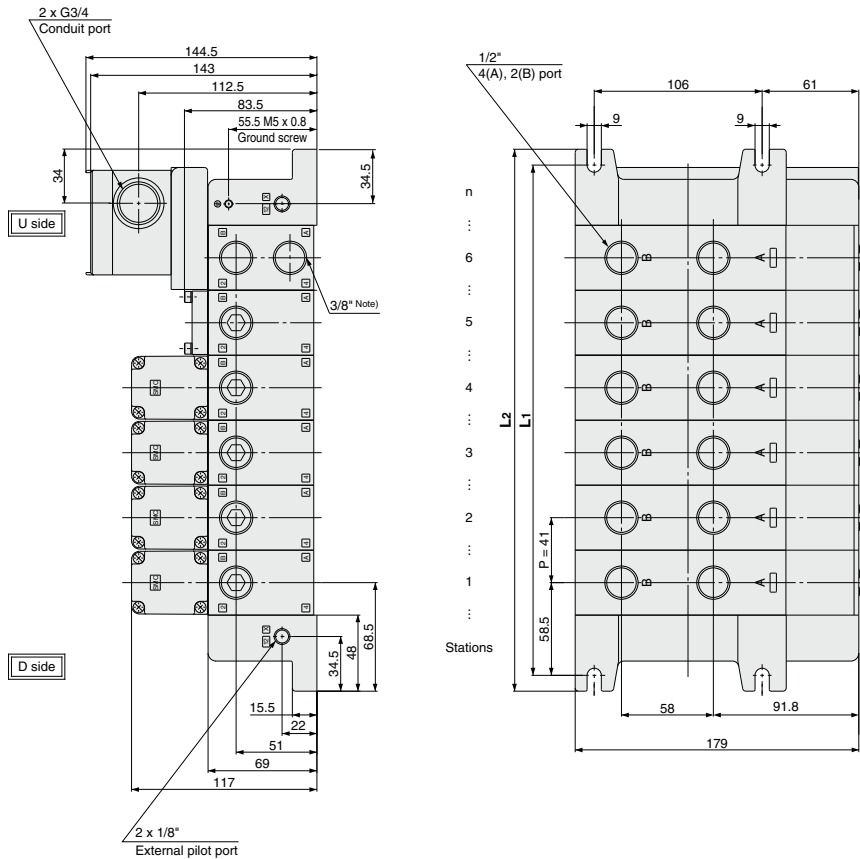

- SV
- SYJ
- SZ
- VF
- VP4
- VQ 1/2
- VQ 4/5
- VQC 1/2
- VQC 4/5
- VQZ
- SQ
- VFS
- VFR
- VQ7

Formula: $L_1 = 41n + 76$, $L_2 = 41n + 96$
 n: Stations (Maximum 12 stations)

Dimensions

* Including 1 station for mounting terminal box.

L	n	2	3	4	5	6	7	8	9	10	11	12
L ₁		158	199	240	281	322	363	404	445	486	527	568
L ₂		178	219	260	301	342	383	424	465	506	547	588

Note) 4(A) and 2(B) port at the bottom of the terminal block box are 3/8".

VQ5000 Series



Kit (Individual terminal block kit)

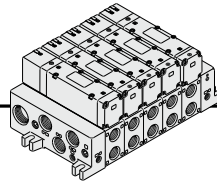

- When the junction cover on the manifold is opened, terminal box is installed in the manifold block. Lead wire from a solenoid is connected with the terminals on the terminal box in the bottom side. (The terminal box is connected with lead wire for both SOL. A and SOL. B and they correspond with the marking 1, 2, 3, 4 on the terminal box. Refer to how to connect with the terminal box.)
- Maximum stations are 12.

Manifold Specifications

Series	Porting specifications		Applicable stations
	4(A), 2(B) port location	Port size	
VQ5000	Side	3/4	Max. 12 stations
	Bottom	1/2	

Terminal Block Connections

Terminal block marking	1	3	2	4
VQ510 ⁰ ₁	A side +	A side -		
VQ520 ⁰ ₁	A side +	A side -	B side +	B side -
VQ540 ⁰ ₅	A side +	A side -	B side +	B side -

- Compatible crimp terminals: 1.25-3S, 1.25Y-3, 1.25Y-3N, 1.25Y-3.5
- There is no polarity (+, -).

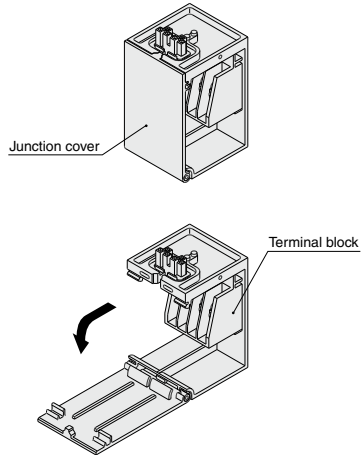
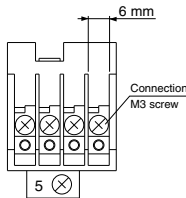
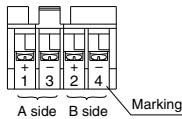

How to Order Manifold

VV5Q 5 1 - 08 03 T1 - - -

Series
5 VQ5000

Manifold
1 Plug-in unit

Stations
1 1 station
⋮ ⋮
12 12 stations

Cylinder port
03 3/8
04 1/2
B Bottom ported 1/2
CM Mixed

Thread type
Nil Rc
F G
N NPT
T NPTF

CE-compliant

Nil	—
Q	CE-compliant

Option

Symbol	Option
Nil	None
CD1 (Note)	Exhaust cleaner for Rc 1: D side exhaust
CD2 (Note)	Exhaust cleaner for Rc 1 1/2: D side exhaust
CU1 (Note)	Exhaust cleaner for Rc 1: U side exhaust
CU2 (Note)	Exhaust cleaner for Rc 1 1/2: U side exhaust
SB	Direct exhaust with silencer box: Exhaust from both U and D sides
SD (Note)	Direct exhaust with silencer box: D side exhaust
SU (Note)	Direct exhaust with silencer box: U side exhaust

(Note) Combination of [C₁] and [S₁] is not possible.



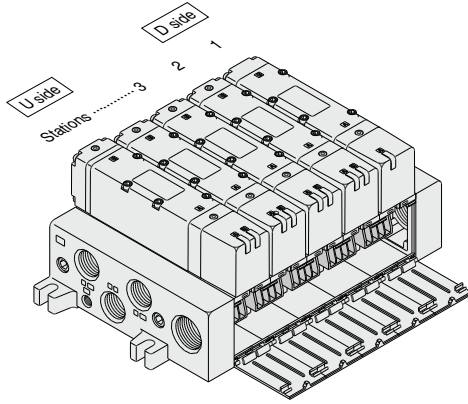

How to Order Valves

How to Order Manifold Assembly

Specify the part numbers for valves and options together beneath the manifold base part number.

<Example>

Individual terminal block kit
VV5Q51-0503T1(-Q).....1 set—Manifold base part no.
 ***VQ5100-51(-Q).....2 sets—Valve part no. (Stations 1 and 2)**
 ***VQ5200-51(-Q).....2 sets—Valve part no. (Stations 3 and 4)**
 ***VQ5300-51(-Q).....1 set—Valve part no. (Station 5)**

Prefix the asterisk to the part nos. of the valve etc.

Enter in order starting from the first station on the D side. When entry of part numbers becomes complicated, indicate in the manifold specification sheet.

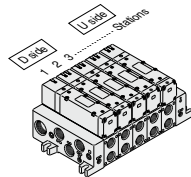

VQ 5 1 0 0 - 5 - 1 -

Series

5	VQ5000
---	--------

Type of actuation

1	2-position single
2	2-position double
3	3-position closed center
4	3-position exhaust center
5	3-position pressure center
6	3-position double check

Seal

0	Metal seal
1	Rubber seal

CE-compliant

Nil	—
Q	CE-compliant

Note) CE-compliant: For DC only.

Manual override

Nil	Non-locking push type (Tool required)
B	Locking type (Tool required)
C	Locking type (Manual)

Light/Surge voltage suppressor

Nil	Yes
E	Without light, with surge voltage suppressor

Coil voltage

1	100 VAC (50/60 Hz)
2	200 VAC (50/60 Hz)
3	110 VAC (50/60 Hz)
4	220 VAC (50/60 Hz)
5	24 VDC
6	12 VDC

Function

Nil	Note 1) Standard (0.95 W)
Y	Note 2) Low wattage type (0.4 W)
R	Note 3) External pilot

Note 1) When the unit is energized continuously, refer to "Specific Product Precautions 1" on page 533.
 Note 2) In addition, only DC is available with Y.
 Note 3) For details about external pilot specifications, refer to page 527.
 Note 4) When multiple symbols are specified, indicate them alphabetically.

SV
SYJ
SZ
VF
VP4
VQ 1/2
VQ 4/5
VQC 1/2
VQC 4/5
VQZ
SQ
VFS
VFR
VQ7

Bottom ported drawing

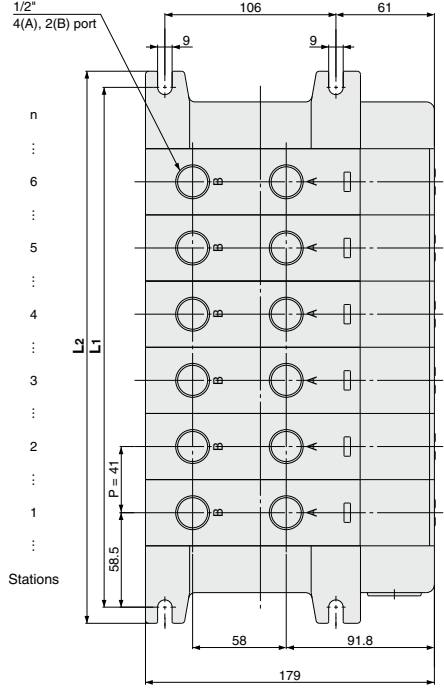
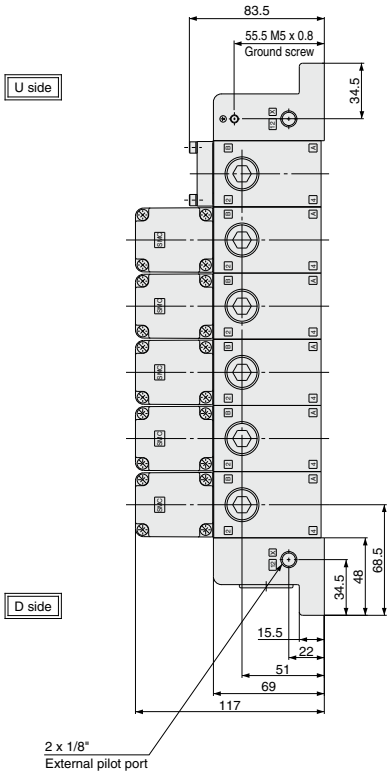

- SV
- SYJ
- SZ
- VF
- VP4
- VQ 1/2
- VQ 4/5**
- VQC 1/2
- VQC 4/5
- VQZ
- SQ
- VFS
- VFR
- VQ7

Dimensions Formula: $L_1 = 41n + 76$, $L_2 = 41n + 96$ n: Stations (Maximum 12 stations)

n	1	2	3	4	5	6	7	8	9	10	11	12
L1	117	158	199	240	281	322	363	404	445	486	527	568
L2	137	178	219	260	301	342	383	424	465	506	547	588

VQ5000 Series

L Kit (Lead wire cable)

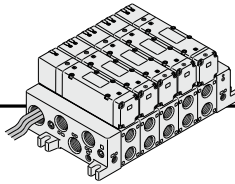

IP65 compliant

- Enclosure IP65 compliant
- Direct electrical entry type available with two or more stations.
- Electrical entry can be selected on either the U side or the D side according to the mounting orientation.
- Maximum stations are 12.

Manifold Specifications

Series	Porting specifications			Applicable stations
	4(A), 2(B) port location	Port size		
		1(P), 5(R1), 3(R2)	4(A), 2(B)	
VQ5000	Side	3/4	3/8	Max. 12 stations
	Bottom		1/2	

Wiring Specifications

Three lead wires are attached to each station regardless of the type of valve which is mounted. The red wire is for COM connection.

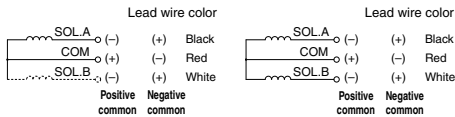

Single solenoid

Double solenoid

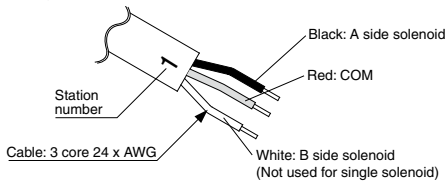

For different lead wire lengths, order a lead wire assembly with connector shown in the table on the right.

Lead Wire Assembly with Connector

Lead wire length	Part no.
0.6 m	VVQ5000-44A-8-□
1.5 m	VVQ5000-44A-15-□
3 m	VVQ5000-44A-30-□

□: Number of stations 1 to 12

How to Order Manifold



VV5Q 5 1 - 08 03 L U - - -

Series
5 VQ5000

Manifold
1 Plug-in unit

Stations

01	1 station
⋮	⋮
12	12 stations

Cylinder port

03	3/8
04	1/2
B	Bottom ported 1/2
CM	Mixed

Cable (Length)

0	Cable length 0.6 m
1	Cable length 1.5 m
2	Cable length 3 m

Electrical entry

D	D side entry
U	U side entry

Thread type

Nil	Rc
F	G
N	NPT
T	NPTF

CE-compliant

Nil	—
Q	CE-compliant

Option

Symbol	Option
Nil	None
CD1 ^{Note 1)}	Exhaust cleaner for Rc 1: D side exhaust
CD2 ^{Note 1)}	Exhaust cleaner for Rc 1 1/2: D side exhaust
CU1 ^{Note 1)}	Exhaust cleaner for Rc 1: U side exhaust
CU2 ^{Note 1)}	Exhaust cleaner for Rc 1 1/2: U side exhaust
SB	Direct exhaust with silencer box: Exhaust from both U and D sides
SD ^{Note 1)}	Direct exhaust with silencer box: D side exhaust
SU ^{Note 1)}	Direct exhaust with silencer box: U side exhaust
W	IP65 enclosure

Note 1) Combination of [C□] and [S□] is not possible.
Note 2) When multiple symbols are specified, indicate them alphabetically.
Example) -CD1W.

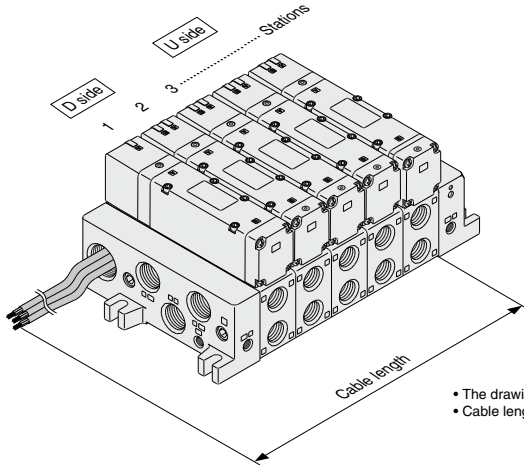

- The drawing shows the electrical entry on the D side.
- Cable length is measured from the valve body.



How to Order Valves

How to Order Manifold Assembly

Specify the part numbers for valves and options together beneath the manifold base part number.

VQ 5 1 0 0 - 5 - - - - 1 -

Series
5 VQ5000

Type of actuation

1	2-position single
2	2-position double
3	3-position closed center
4	3-position exhaust center
5	3-position pressure center
6	3-position double check

Seal

0	Metal seal
1	Rubber seal

CE-compliant

Nil	—
Q	CE-compliant

Note) CE-compliant: For DC only.

Enclosure

Nil	Dust-protected
W	Dust-tight/ Water-jet-proof(IP65)

Manual override

Nil	Non-locking push type (Tool required)
B	Locking type (Tool required)
C	Locking type (Manual)

Light/Surge voltage suppressor

Nil	Yes
E	Without light, with surge voltage suppressor

Coil voltage

1	100 VAC (50/60 Hz)
2	200 VAC (50/60 Hz)
3	110 VAC (50/60 Hz)
4	220 VAC (50/60 Hz)
5	24 VDC
6	12 VDC

Function

Nil (Note 1)	Standard type (0.95 W)
Y (Note 2)	Low wattage type (0.4 W)
R (Note 3)	External pilot

- Note 1) When the unit is energized continuously, refer to "Specific Product Precautions 1" on page 533.
 Note 2) In addition, only DC is available with Y.
 Note 3) For details about external pilot specifications, refer to page 527.
 Note 4) When multiple symbols are specified, indicate them alphabetically.

<Example>

Lead wire kit with cable (3 m)
 WV5Q51-0503LD2(-Q)-1 set—Manifold base part no.
 *VQ5100-51(-Q).....2 sets—Valve part no. (Stations 1 and 2)
 *VQ5200-51(-Q).....2 sets—Valve part no. (Stations 3 and 4)
 *VQ5300-51(-Q).....1 set—Valve part no. (Station 5)

Prefix the asterisk to the part nos. of the valve etc.

Enter in order starting from the first station on the D side. When entry of part numbers becomes complicated, indicate in the manifold specification sheet.

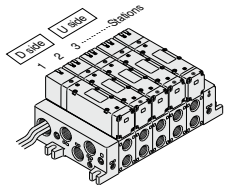

SV
SYJ
SZ
VF
VP4
VQ 1/2
VQ 4/5
VQC 1/2
VQC 4/5
VQZ
SQ
VFS
VFR
VQ7

VQ5000 Series

L Kit (Lead wire cable)

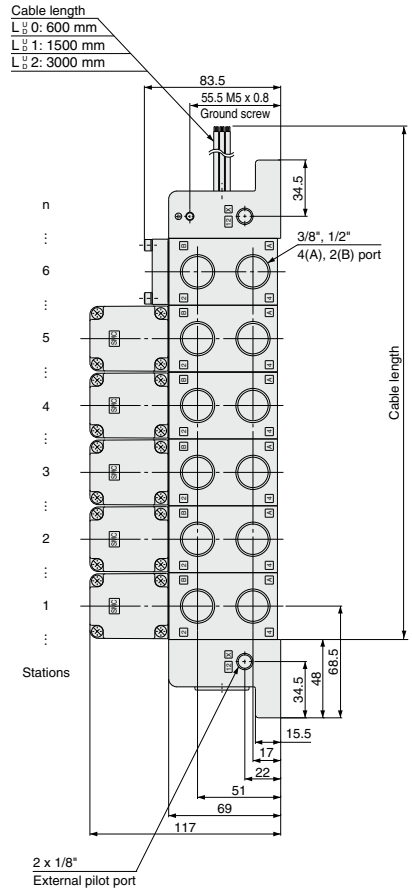
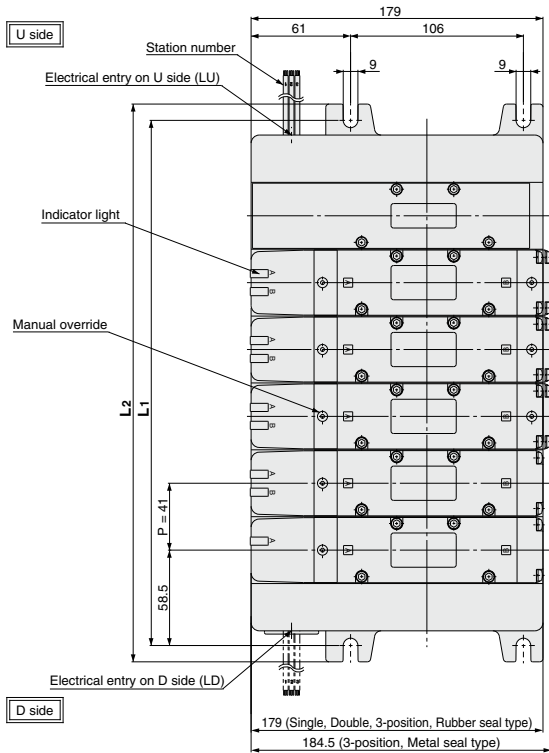
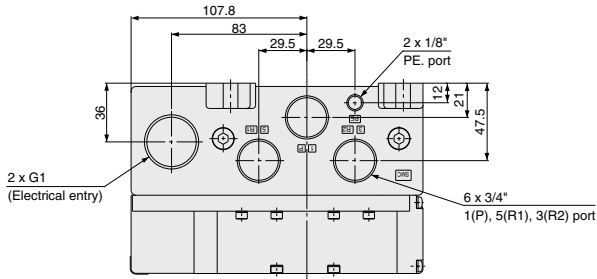

Bottom ported drawing

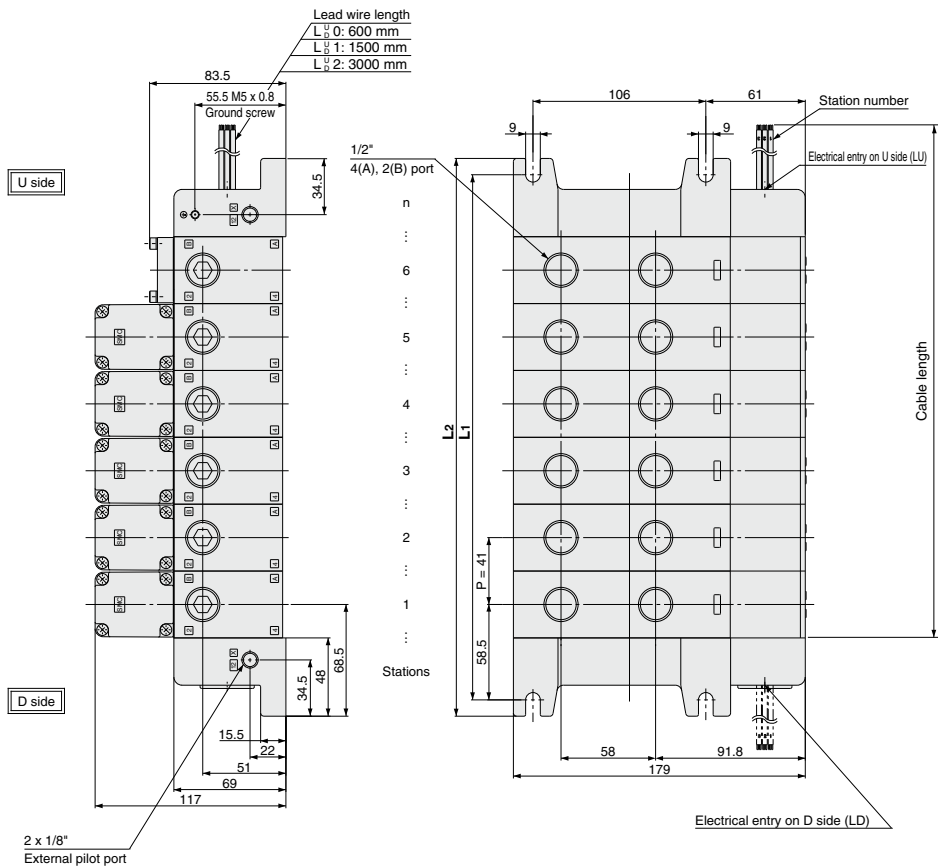

- SV
- SYJ
- SZ
- VF
- VP4
- VQ 1/2
- VQ 4/5**
- VQC 1/2
- VQC 4/5
- VQZ
- SQ
- VFS
- VFR
- VQ7

Dimensions

Formula: $L_1 = 41n + 76$, $L_2 = 41n + 96$ n: Stations (Maximum 12 stations)

L	n	1	2	3	4	5	6	7	8	9	10	11	12
L ₁		117	158	199	240	281	322	363	404	445	486	527	568
L ₂		137	178	219	260	301	342	383	424	465	506	547	588

VQ5000 Series

S

Kit (Serial transmission unit): EX123/124 (For Output) Serial Transmission System **IP65 compliant**

- The serial transmission system reduces wiring work, while minimizing wiring and saving space.

Manifold Specifications

Series	4(A), 2(B) port location	Porting specifications		Applicable stations
		Port size		
		1(P), 5(R1), 3(R2)	4(A), 2(B)	
VQ5000	Side	3/4	3/8	Max. 12 stations
	Bottom		1/2	

- Double wiring (connected to SOL. A and SOL. B) is adopted for the internal wiring of each station, regardless of valve and option types. Mixed single and double wiring is available as a semi-standard specification.

Item	Specifications
External power supply	24 VDC +10%, -5%
Current consumption (Internal unit)	0.1 A



How to Order Manifold

VV5Q 5 1 - 08 03 **S U Q** - -

Series	Manifold	Stations
5 VQ5000	1 Plug-in unit	02 2 stations ... 12 12 stations

Note) One station is used for mounting SI Unit.
The number of stations is the number of manifold valves plus one station for SI Unit. For 10 stations or more, specify the wiring specifications by means of the manifold specification sheet.

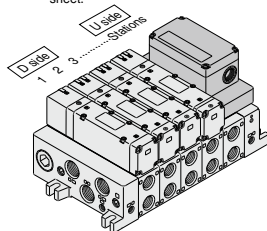

* Stations are counted starting from the first station on the D side.

Cylinder port	
03	3/8
04	1/2
B	Bottom ported 1/2
CM	Mixed

Thread type	
Nil	Rc
F	G
N	NPT
T	NPTF

SI Unit mounting position

D	D side mounting
U	U side mounting

CE-compliant

Nil	—
Q	CE-compliant

Option

Symbol	Option
Nil	None
CD1	Exhaust cleaner for Rc 1: D side exhaust
CD2	Exhaust cleaner for Rc 1 1/2: D side exhaust
CU1	Exhaust cleaner for Rc 1: U side exhaust
CU2	Exhaust cleaner for Rc 1 1/2: U side exhaust
K	Special wiring specifications (except double wiring specification, 10 stations or more)
SD	Direct exhaust with silencer box: D side exhaust
SU	Direct exhaust with silencer box: U side exhaust
W	IP65 enclosure

Note 1) When multiple symbols are specified, indicate them alphabetically.

Example) -CD1K

Note 2) Combination of [C] and [S] is not possible.

Note 3) Specify the wiring specifications on the manifold specification sheet.

SI Unit

	Without SI Unit	CE-compliant
0		●
H	NKE Corp.: Fieldbus H System (16 output points)	—
Q	DeviceNet™ (16 output points)	●
R1	OMRON Corp.: CompoBus/S System (16 output points)	●
R2	OMRON Corp.: CompoBus/S System (8 output points)	●
V	CC-LINK (16 output points)	●

SI Unit Part No.

Symbol	Protocol type	SI Unit part no.	Page
H	NKE Corp.: Fieldbus H System (16 output points)	D side: EX123D-SUH1	531
		U side: EX123U-SUH1	
Q	DeviceNet™ (16 output points)	D side: EX124D-SDN1	531
		U side: EX124U-SDN1	
R1	OMRON Corp.: CompoBus/S System (16 output points)	D side: EX124D-SCS1	531
		U side: EX124U-SCS1	
R2	OMRON Corp.: CompoBus/S System (8 output points)	D side: EX124D-SCS2	531
		U side: EX124U-SCS2	
V	CC-Link (16 output points)	D side: EX124D-SMJ1	531
		U side: EX124U-SMJ1	

Refer to Best Pneumatics No. 1-1 and the Operation Manual for the details of EX123/124 Integrated-type (For Output) Serial Transmission System. Please download the Operation Manual via SMC website, <http://www.smcworld.com>



How to Order Valves

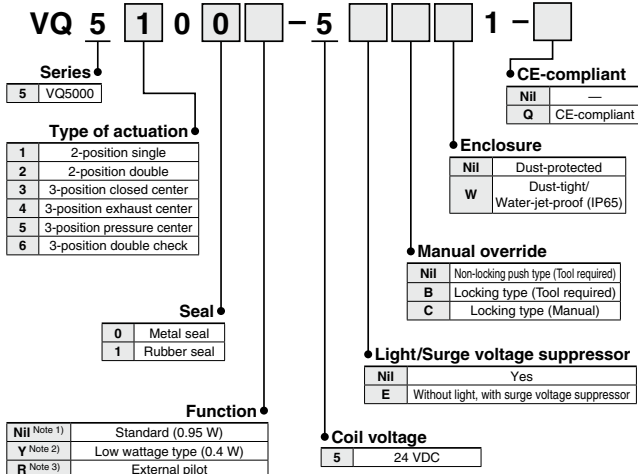

Note 1) When the unit is energized continuously, refer to "Specific Product Precautions 1" on page 533.
 Note 2) In addition, only DC is available with Y.
 Note 3) For details about external pilot specifications, refer to page 527.
 Note 4) When multiple symbols are specified, indicate them alphabetically.

How to Order Manifold Assembly

Specify the part numbers for valves and options together beneath the manifold base part number.

<Example>

VV5Q51-0603SUQ(-Q)-1 set—Manifold base part no.
 *VQ5100-51(-Q).....2 sets—Valve part no. (Stations 1 and 2)
 *VQ5200-51(-Q).....2 sets—Valve part no. (Stations 3 and 4)
 *VQ5300-51(-Q).....1 set—Valve part no. (Station 5)

Prefix the asterisk to the part nos. of the valve etc.

Enter in order starting from the first station on the D side. When entry of part numbers becomes complicated, indicate in the manifold specification sheet.

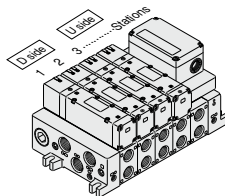

- SV
- SYJ
- SZ
- VF
- VP4
- VQ 1/2
- VQ 4/5
- VQC 1/2
- VQC 4/5
- VQZ
- SQ
- VFS
- VFR
- VQ7

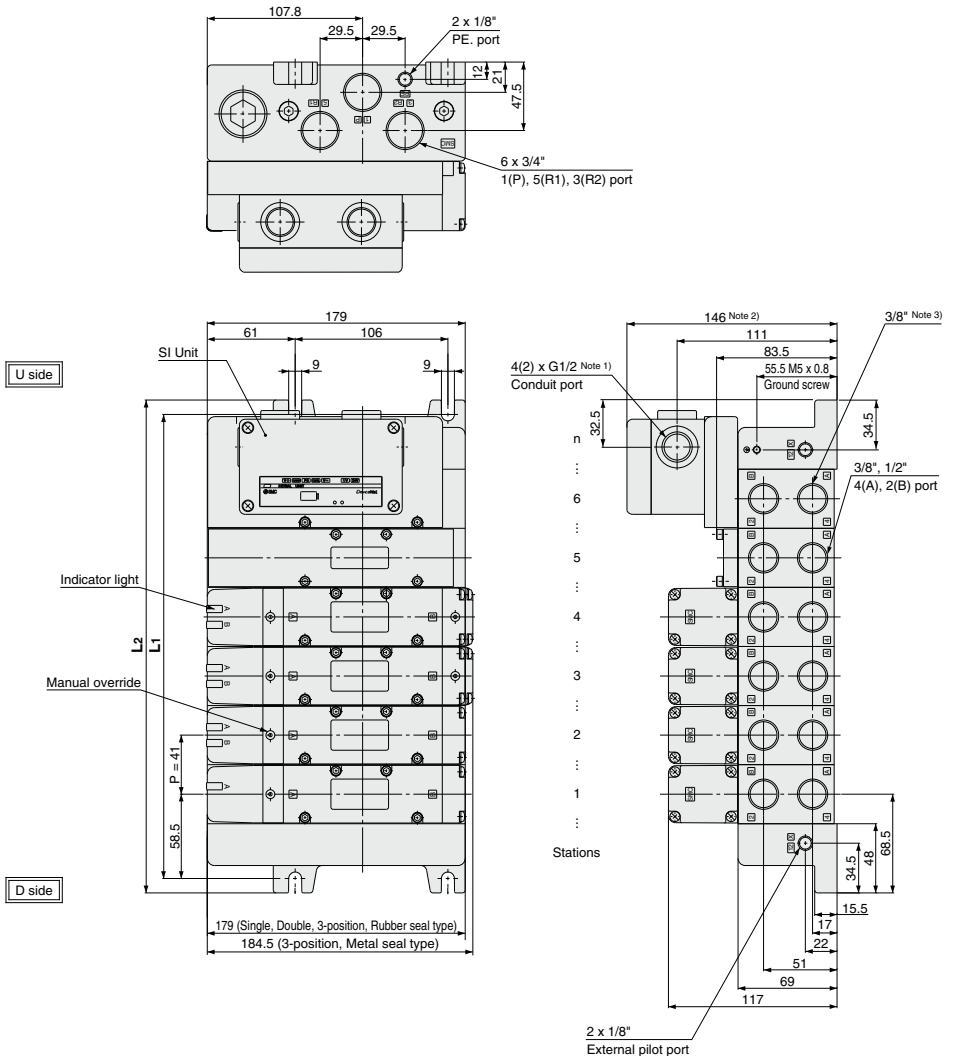

Note 1) When the SI Unit is EX124D(U), conduit port (G1/2) will be 4 locations. In the case of EX123D(U), conduit port will be 2 locations.

Note 2) In the case of EX124D(U)-SMJ1, this dimension becomes 149.

Note 3) 4(A) and 2(B) port at the bottom of the SI Unit are 3/8".

Bottom port drawing

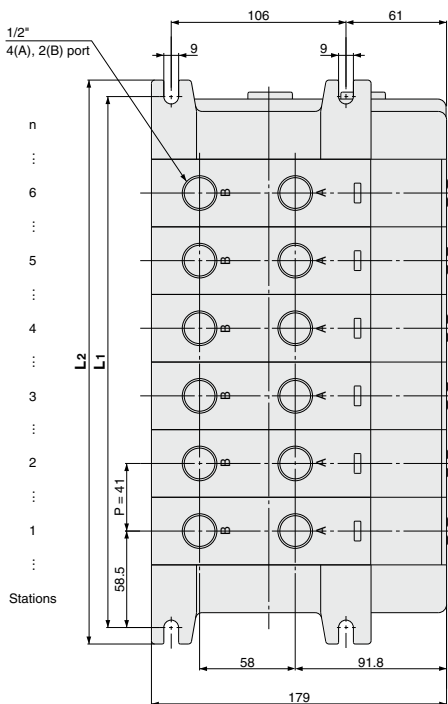
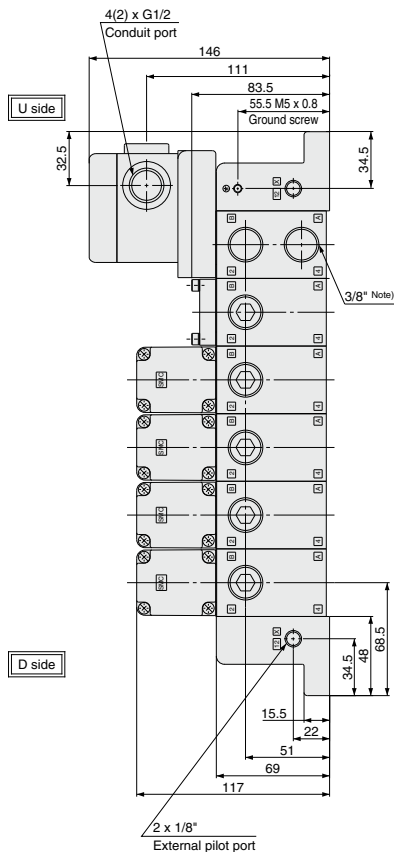

- SV
- SYJ
- SZ
- VF
- VP4
- VQ 1/2
- VQ 4/5
- VQC 1/2
- VQC 4/5
- VQZ
- SQ
- VFS
- VFR
- VQ7

Formula: $L_1 = 41n + 76$, $L_2 = 41n + 96$
 n: Stations (Maximum 12 stations)
 * Including 1 station for mounting SI Unit.

Dimensions

n	2	3	4	5	6	7	8	9	10	11	12
L1	158	199	240	281	322	363	404	445	486	527	568
L2	178	219	260	301	342	383	424	465	506	547	588

Note) 4(A) and 2(B) port at the bottom of the SI Unit are 3/8".

Base Mounted

Plug Lead Unit: C Kit (Connector Kit)

VQ5000 Series



[Option]
Note) CE-compliant:
For DC only.

How to Order Manifold

VV5Q 5 5 - 08 03 [] C - [] - []

Series
5 VQ5000

Manifold
5 Plug lead unit

Stations
01 1 station
: :
12 12 stations

Cylinder port
03 3/8
04 1/2
B Bottom ported 1/2
CM Mixed

Thread type

Nll	Rc
F	G
N	NPT
T	NPTF

Kit type
C Kit (Connector)

CE-compliant

Nll	—
Q	CE-compliant

Option

Symbol	Option
Nll	None
CD1	Exhaust cleaner for Rc 1: D side exhaust
CD2	Exhaust cleaner for Rc 1 1/2: D side exhaust
CU1	Exhaust cleaner for Rc 1: U side exhaust
CU2	Exhaust cleaner for Rc 1 1/2: U side exhaust
SB	Direct exhaust with silencer box: Exhaust from both U and D sides
SD	Direct exhaust with silencer box: D side exhaust
SU	Direct exhaust with silencer box: U side exhaust
W	IP65 enclosure

Note 1) Combination of [C] and [S] is not possible. Also, exhaust cleaner is not attached. Please order it separately.

Refer to page 534 (Grommet type) for wiring specifications.

C	Connector kit	Max. 12 stations
---	---------------	------------------

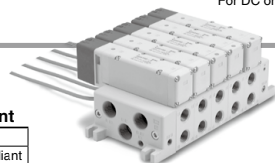

How to Order Valves

VQ 5 1 5 0 [] - 5 G [] [] [] 1 - []

Series
5 VQ5000

Type of actuation

1	2-position single
2	2-position double
3	3-position closed center
4	3-position exhaust center
5	3-position pressure center
6	3-position double check

Seal

0	Metal seal
1	Rubber seal

Function

Nll	Standard (0.95 W)
Y	Low wattage type (0.4 W)
R	External pilot

Note 1) When the unit is energized continuously, refer to "Specific Product Precautions 1" on page 533.
Note 2) In addition, only DC is available with Y.
Note 3) For details about external pilot specifications, refer to page 527.
Note 4) When multiple symbols are specified, indicate them alphabetically.

Coil voltage

1	100 VAC (50/60 Hz)	4	220 VAC (50/60 Hz)
2	200 VAC (50/60 Hz)	5	24 VDC
3	110 VAC (50/60 Hz)	6	12 VDC

CE-compliant

Nll	—
Q	CE-compliant

Note) CE-compliant:
For DC only.

Enclosure

Nll	Dust-protected
W	Dust-tight/ Water-jet-proof (IP65)

Manual override

Nll:	Non-locking push type (Tool required)
B:	Locking type (Tool required)
C:	Locking type (Manual)

Light/Surge voltage suppressor

Nll	Yes
E	Without light, with surge voltage suppressor

Electrical entry

G	Lead wire length 0.6 m
H	Lead wire length 1.5 m

How to Order Manifold Assembly

Specify the part numbers for valves and options together beneath the manifold base part number.

<Example>

- Connector kit
VV505-05042C(-Q)-...1 set—Manifold base part no.
***VQ5150-5G1(-Q)-...2 sets**—Valve part no. (Stations 1 and 2)
***VQ5250-5G1(-Q)-...2 sets**—Valve part no. (Stations 3 and 4)
***VQ5350-5G1(-Q)-...1 set**—Valve part no. (Station 5)

Prefix the asterisk to the part nos. of the valve etc.

Enter in order starting from the first station on the D side. When entry of part numbers becomes complicated, indicate in the manifold specification sheet.

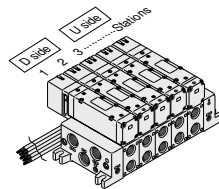

Manifold Specifications

Series	Base model	Type of connection	Porting specifications		Maximum applicable stations	Applicable valve	Weight [kg] (Formula)	
			4(A), 2(B) port location	Port size				
				1(P), 5(R1), 3(R2)				4(A), 2(B)
VQ5000	VV5Q55-□□□	■ C kit-Grommet	Side	3/4 Option Direct exhaust with silencer box	3/8 1/2	2 to 12 stations	VQ5□50 VQ5□51	0.58n + 0.9 • Not including valve weight.
			Bottom					

n: Stations

Flow Rate Characteristics at the Number of Manifold Stations (Operated individually)

Model	Passage/Stations	Station 1	Station 5	Station 10	
2-position metal seal VQ5₀₀	1 → 4/2 (P → A/B)	C [dm ³ /(s·bar)]	11	11	11
		b	0.24	0.24	0.24
		Cv	2.7	2.7	2.7
	4/2 → 5/3 (A/B → EA/EB)	C [dm ³ /(s·bar)]	12	12	12
		b	0.14	0.14	0.14
		Cv	2.9	2.9	2.9
2-position rubber seal VQ5₀₁	1 → 4/2 (P → A/B)	C [dm ³ /(s·bar)]	12	12	12
		b	0.33	0.33	0.33
		Cv	3.4	3.4	3.4
	4/2 → 5/3 (A/B → EA/EB)	C [dm ³ /(s·bar)]	16	16	16
		b	0.33	0.33	0.33
		Cv	4.4	4.4	4.4

(Note) For port size 1/2

Manifold Options

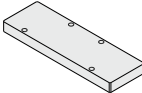
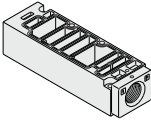
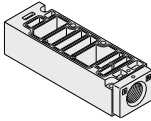
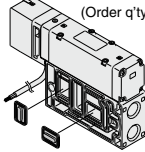
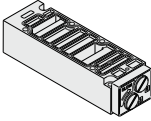
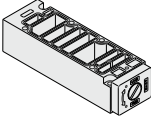
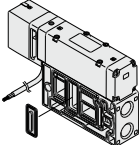
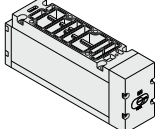
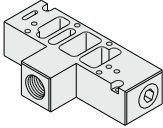
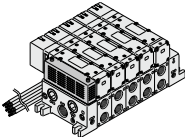
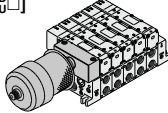
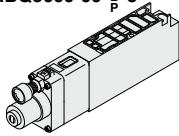
Blanking plate assembly VVQ5000-10A-5 	Individual SUP spacer VVQ5000-P-5₀₃⁰⁴ 	Individual EXH spacer VVQ5000-R-5₀₃⁰⁴ 	EXH block plate VVQ5000-16A-2 (1 pc./set) (Order qty: 2 pcs.) 
Restrictor spacer VVQ5000-20A-5 	SUP stop valve spacer VVQ5000-37A-5 	SUP block plate VVQ5000-16A-1 	Double check spacer with residual pressure exhaust VVQ5000-25A-5 
Release valve spacer: For D side mounting VVQ5000-24A-5D 	Direct exhaust with silencer box [-S₀□] 	Manifold mounted exhaust cleaner [-C₀□] 	Interface regulator (P, A, B port regulation) ARBQ5000-00-$\frac{A}{B}$-5 

- Refer to pages 522 to 526 for detailed dimensions of each option.
- For replacement parts, refer to page 531.

SV

SYJ

SZ

VF

VP4

VQ
1/2

VQ
4/5

VQC
1/2

VQC
4/5

VQZ

SQ

VFS

VFR

VQ7

VQ5000 Series

C

Kit (Connector kit)

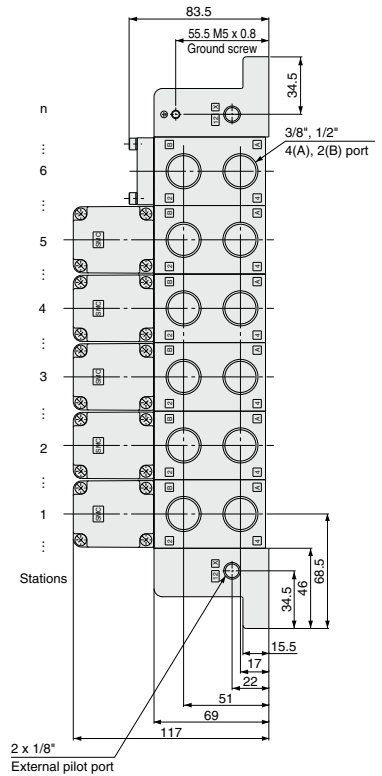
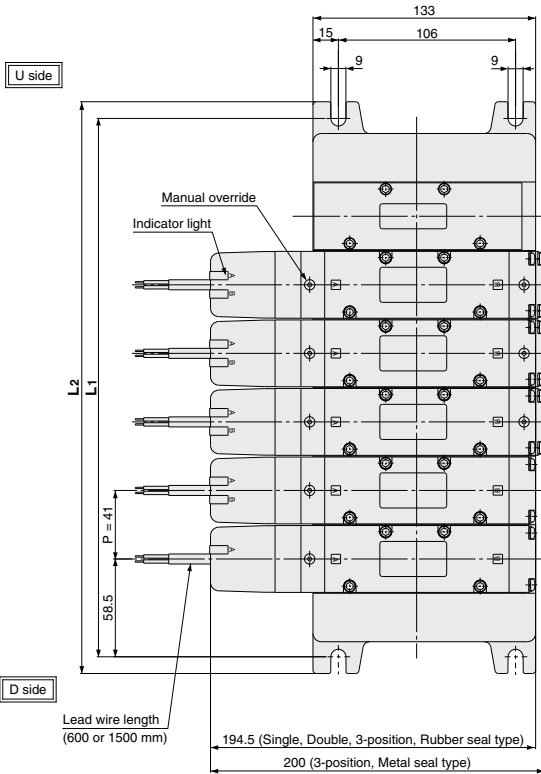
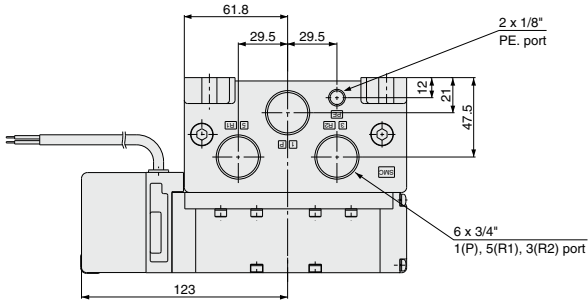

VQ5000 Series Manifold Options

Manifold Option Parts

Blanking plate assembly

VVQ5000-10A-1 (Plug-in type)

VVQ5000-10A-5 (Plug lead type)

It is used by attaching on the manifold block for being prepared for removing a valve for maintenance reasons or planning to mount a spare valve etc.

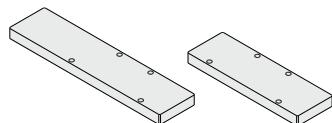

Plug-in type

Plug lead type

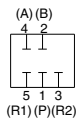

Circuit diagram

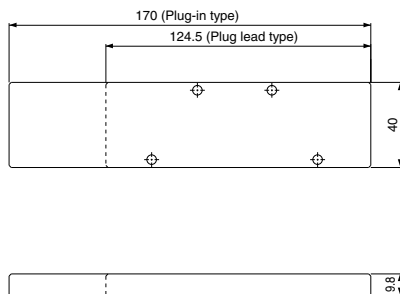

Individual SUP spacer

VVQ5000 - P - 1 - 03

Manifold	
1	Plug-in type
5	Plug lead type

Port size	
03	3/8
04	1/2

Thread type	
Nil	Rc
F	G
N	NPT
T	NPTF

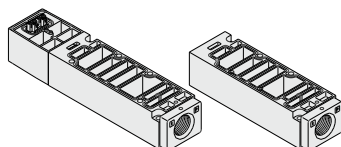

Plug-in type

Plug lead type

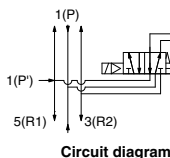

Circuit diagram

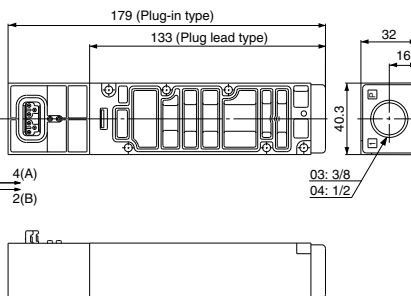

Individual EXH spacer

VVQ5000 - R - 1 - 03

Manifold	
1	Plug-in type
5	Plug lead type

Port size	
03	3/8
04	1/2

Thread type	
Nil	Rc
F	G
N	NPT
T	NPTF

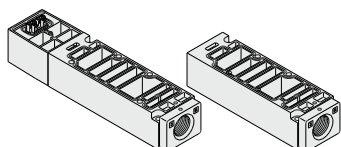

Plug-in type

Plug lead type

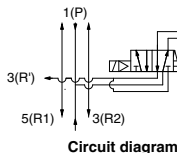

Circuit diagram

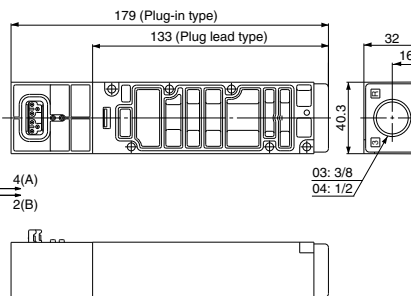

Restrictor spacer

VVQ5000-20A-1 (Plug-in type)
VVQ5000-20A-5 (Plug lead type)

A restrictor spacer is mounted on a manifold block to control cylinder speed by throttling exhaust air flow.

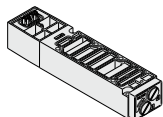

Plug-in type

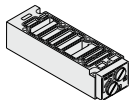

Plug lead type

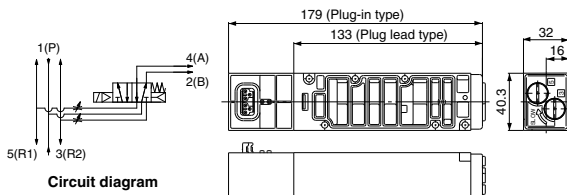

Circuit diagram

Note 1) A certain amount of leakage is allowed in the products' specifications. Tightening the needle to reduce leakage to zero may result in equipment damage.
 Note 2) Products mentioned in this catalog are retainer types, so the needle is not removed completely. Over rotation will cause damage.

SUP stop valve spacer

VVQ5000-37A-1 (Plug-in type)
VVQ5000-37A-5 (Plug lead type)

A SUP stop valve spacer is mounted on a manifold block, making it possible to individually shut off supply air to each valve.

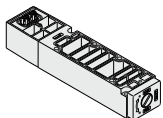

Plug-in type

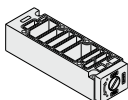

Plug lead type

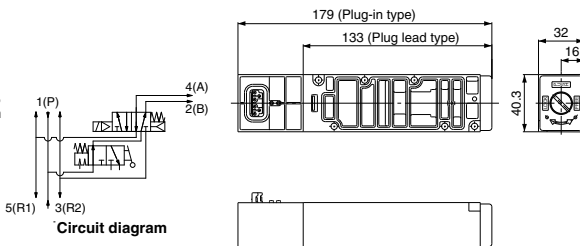

Circuit diagram

Release valve spacer: For D side mounting

VVQ5000-24A-1D (Plug-in type)
VVQ5000-24A-5D (Plug lead type)

A VQ51□□ (single) valve can be used as an air release valve by combining it with a release valve spacer.
 Note) 2-position double and 3-position cannot be mounted.

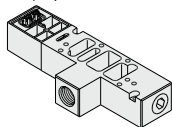

Plug-in type

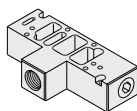

Plug lead type

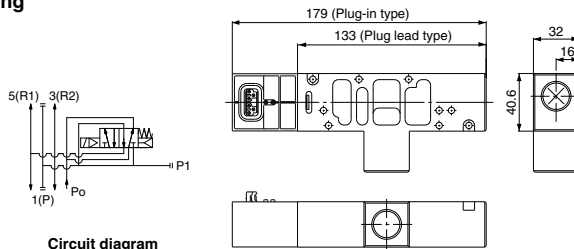

Circuit diagram

SUP block plate

VVQ5000-16A-1

EXH block plate

VVQ5000-16A-2

When supplying two different pressures to one manifold, this is used to shut off between stations with different pressures.

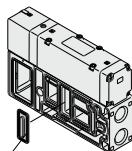

SUP blocking plate

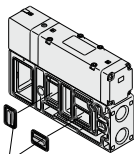

EXH blocking plate
 (Order q'ty: 2 pcs.)

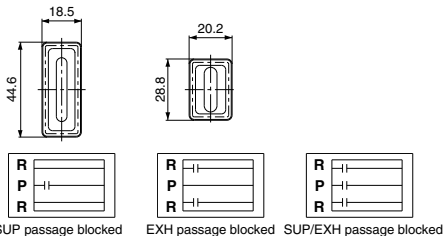

<Passage blocked label>

Indication labels to confirm the blocking position are attached.
 (Each for SUP passage and SUP/EXH passage blocking positions)
 (Each for EXH passage and SUP/EXH passage blocking positions)

SV
 SYJ
 SZ
 VF
 VP4
 VQ 1/2
 VQ 4/5
 VQC 1/2
 VQC 4/5
 VQZ
 SQ
 VFS
 VFR
 VQ7

Manifold Option Parts

Direct exhaust with silencer box

VV5Q5 $\frac{1}{2}$ -□□□-SD (D side exhaust)

VV5Q5 $\frac{1}{2}$ -□□□-SU (U side exhaust)

VV5Q5 $\frac{1}{2}$ -□□□-SB (Exhaust from both sides)

The EXH outlet is placed on the top side of the manifold end plate. The built-in silencer provides highly effective noise reduction. (Noise reduction of 35 dB(A) or more)

Note) Note that when excessive drainage occurs in the air supply, the drainage will be released along with the exhaust.

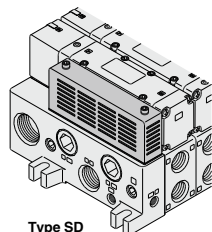
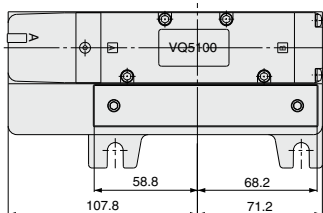

Type SD

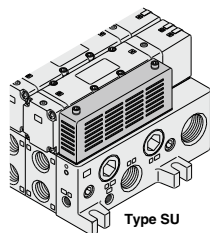

Type SU

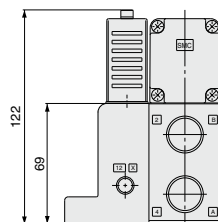
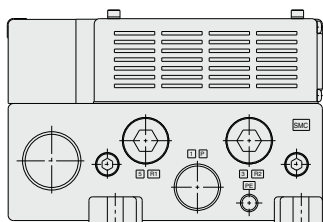

Note) Figure shows VV5Q51-□□□-SD.

• Silencer box assembly: VVQ5000-75A (With gasket, screw)

Double check spacer with residual pressure exhaust

VVQ5000-25A-1 (Plug-in type)

VVQ5000-25A-5 (Plug lead type)

Can hold an intermediate cylinder position for an extended time.

When combined with a double check spacer with built-in double check valve, it is unaffected by air leakage between the spool valves, making it possible to hold a cylinder at an intermediate stopping position for an extended time.

Besides, combination between 2-position solenoid valve (VQ5 $\frac{1}{2}$ □□) and double check spacer can be used for drop prevention.

Plug-in type

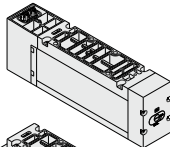

Plug lead type

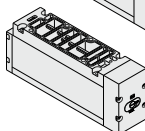

Specifications

Double check spacer part no.	VVQ5000-25A- $\frac{1}{2}$	
	Intermediate stop	Drop prevention
Applicable solenoid valve	VQ54□□	VQ5 $\frac{1}{2}$ □□

Caution

Handling Precautions

- In the case of 3-position double check (VQ56 $\frac{2}{3}$ 0), check the leakage from piping and fittings in between valve and cylinder by means of synthetic detergent solutions, and ensure that there is no such leakage found there. Also, check the leakage from cylinder seal and piston seal. If there is any leakage, sometimes the cylinder, when valve is de-energized, can move without stopping at intermediate position.
- If exhaust side of double check spacer is narrowed down, this causes a decrease in intermediate stop accuracy and may malfunction.
- Combination with 3-position valves "VQ5 $\frac{2}{3}$ □□" is not possible.
- Set the cylinder load so that the cylinder pressure will be within two times that of the supply pressure.

Manifold mounted exhaust cleaner

VV5Q5 ½ -□□□-CD ½ (D side mounting)

VV5Q5 ½ -□□□-CU ½ (U side mounting)

An adapter plate for exhaust cleaner mounting is provided on the top of the manifold end plate. The exhaust cleaner collects drainage and oil mist (99.9% or more) and is highly effective for noise reduction.

(Noise reduction of 35 dB(A) or more)

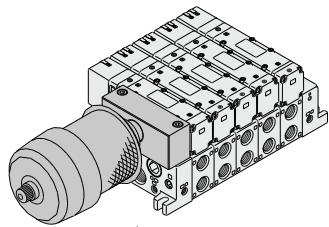
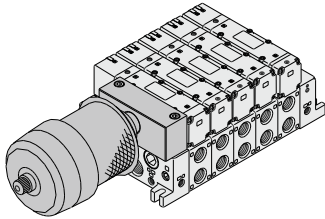

Applicable exhaust cleaners
AMC610-10 (Port size Rc 1), AMC810-14 (Port size Rc 1 1/2)

Note 1) Exhaust cleaner: AMC610-10 and AMC810-14 are not included.
 Please order it separately.
 Note 2) Mount so that the exhaust cleaner is at the lower side.
 Note 3) For details about the exhaust cleaner, refer to Best Pneumatics No. 7.

- SV
- SYJ
- SZ
- VF
- VP4
- VQ 1/2
- VQ 4/5
- VQC 1/2
- VQC 4/5
- VQZ
- SQ
- VFS
- VFR
- VQ7

Plug-in type

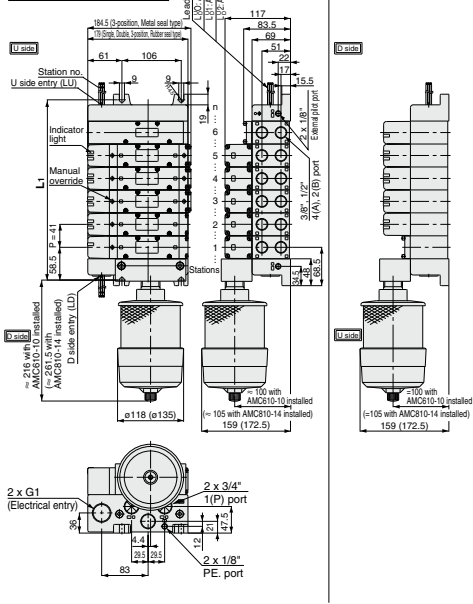

Plug lead type

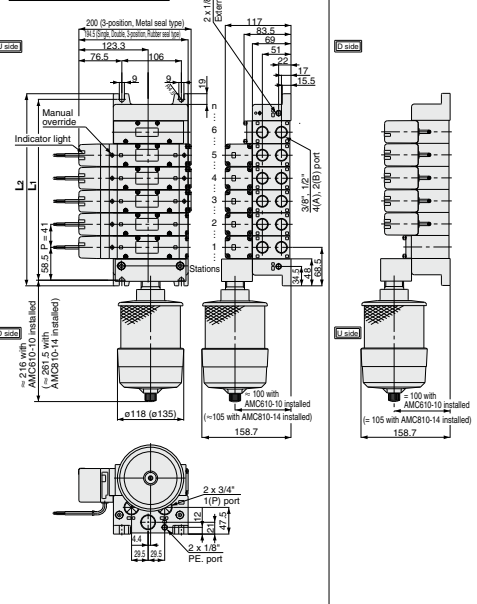

Dimensions

Formula: L1 = 41n + 76, L2 = 41n + 96
 n: Stations (Maximum 12 stations)

L	n	2	3	4	5	6	7	8	9	10	11	12
L1		158	199	240	281	322	363	404	445	486	527	568
L2		178	219	260	301	342	383	424	465	506	547	588

Dimensions

Formula: L1 = 41n + 76, L2 = 41n + 96
 n: Stations (Maximum 12 stations)

L	n	2	3	4	5	6	7	8	9	10	11	12
L1		158	199	240	281	322	363	404	445	486	527	568
L2		178	219	260	301	342	383	424	465	506	547	588

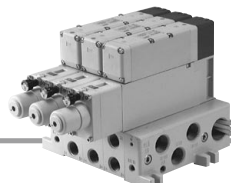

Manifold Option Parts

Interface regulator (P, A, B port regulation)

ARBQ5000-00-□-1 (Plug-in type)

ARBQ5000-00-□-5 (Plug lead type)

By mounting a spacer regulator on the manifold block, it enables to regulate pressure per every valve.

Specifications

Interface regulator		ARBQ5000					
Regulating port		A		B		P	
Applicable valve		Plug-in	Plug lead	Plug-in	Plug lead	Plug-in	Plug lead
Maximum operating pressure		1.0 MPa					
Set pressure range		0.05 to 0.85 MPa					
Fluid		Air					
Ambient and fluid temperature		-5 to 60°C (No freezing)					
Port size for connection of pressure gauge		M5 x 0.8					
Weight [kg]		0.79	0.74	0.78	0.73	0.79	0.74
Effective area at supply side [mm ²] S at P ₁ = 0.7 MPa/P ₂ = 0.5 MPa	P → A	33		75		29	
	P → B	64		33		28	
Effective area at exhaust side [mm ²] S at P ₂ = 0.5 MPa	A → EA	36		75		78	
	B → EB	68		38		69	

Note 1) Set the pressure within the operating pressure range of the valve.

Note 2) Operate an interface regulator only by applying pressure from the P port of the base, except when using it as a reverse pressure valve. When using it as a reverse pressure valve, P port regulation is not allowed to use.

Note 3) When using a perfect spacer, assemble a valve, a spacer regulator and a perfect spacer in this order to use it.

Note 4) When using in A port regulation, B port regulation by closed center, since there is a problem in its operation, please contact SMC.

Note 5) Dust-tight/Water-jet-proof (IP65) is not available with interface regulator.

How to Order

Solenoid valve	Interface regulator	Regulating port
VQ5□□ (Plug-in type)	ARBQ5000-00-A-1	A
	ARBQ5000-00-B-1	B
	ARBQ5000-00-P-1	P
VQ5□5□ (Plug lead type)	ARBQ5000-00-A-5	A
	ARBQ5000-00-B-5	B
	ARBQ5000-00-P-5	P

Dimensions

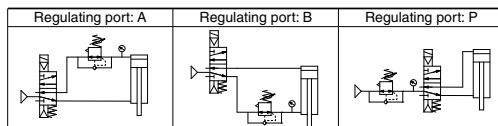
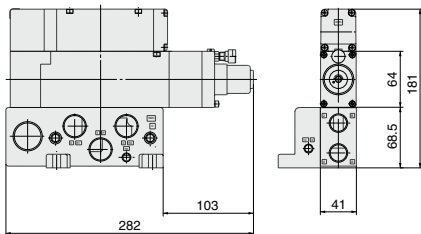

Flow Rate Characteristics

Conditions Inlet pressure: 0.7 MPa

ARBQ5000-00-A (P → A)

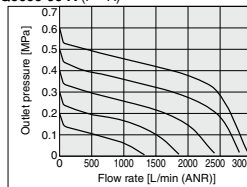

ARBQ5000-00-B (P → B)

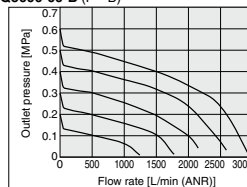

ARBQ5000-00-P (P → A)

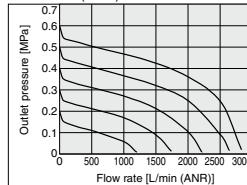

ARBQ5000-00-P (P → B)

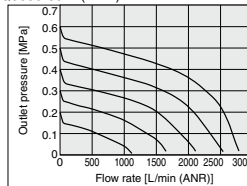

Pressure Characteristics

Conditions

Inlet pressure: 0.7 MPa

Outlet pressure: 0.2 MPa

Flow rate: 20 L/min (ANR)

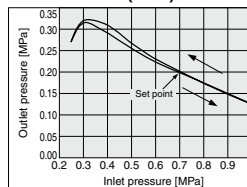

VQ5000 Series

Semi-standard Specifications

External Pilot Specifications

- When the supply pressure is:
 - lower than the minimum valve operating pressure of 0.1 to 0.2 MPa, or when it drops below this level,
 - used for reverse pressure (R port pressure) or cylinder pressure (A, B port pressure),
 - used for vacuum specification, it can be used for external pilot specification. Order a valve by adding the external pilot specification [R] to the part number. External pilot is available as standard for manifolds and options.
- Compatibility with universal porting is possible for the single, double and 3-position (excluding double check) types.

Pressure Specifications

Valve construction	Metal seal	Rubber seal
Operating pressure range	-100 kPa to 1.0 MPa	
External pilot pressure range	Single	0.2 to 1.0 MPa
	Double	0.15 to 1.0 MPa
	3-position	0.2 to 1.0 MPa

How to Order Valves

VQ5100 **[R]** - 5 - 04

● External pilot

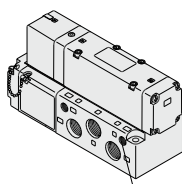

External pilot port
1/8

<Sub-plate>

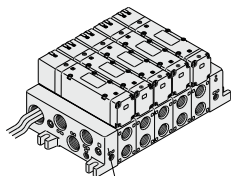

External pilot port
2 x 1/8

<Manifold>

Note) Possible to mix mounting of internal and external pilot

SV

SYJ

SZ

VF

VP4

VQ

1/2

VQ

4/5

VQC

1/2

VQC

4/5

VQZ

SQ

VFS

VFR

VQ7

Plug Lead Unit

Metal seal type

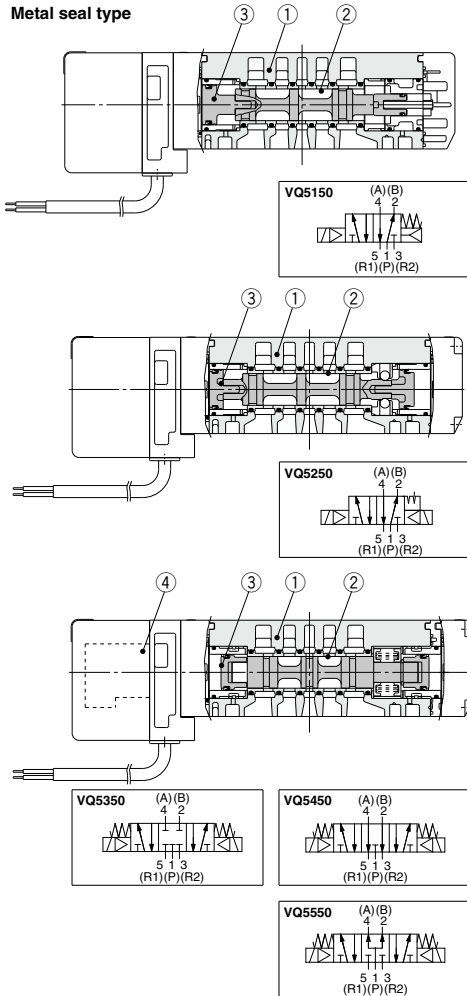

Component Parts

No.	Description	Material	Note
1	Body	Aluminum die-casted	
2	Spool/Sleeve	Stainless steel	
3	Piston	Resin	

Replacement Parts

4	Pilot valve assembly	V118□□□ A B E	□: Coil rated voltage Example) 24 VDC: 5 A: With light (For A side) B: With light (For B side) E: Without light (A/B side common)
		•Coil type Nil Standard (0.95 W) Y Low wattage type (0.4 W)	

Rubber seal type

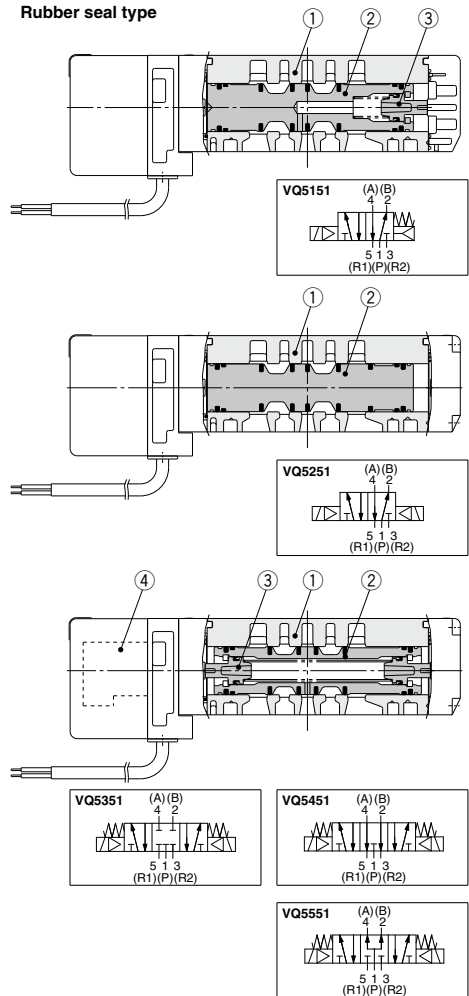

Component Parts

No.	Description	Material	Note
1	Body	Aluminum die-casted	
2	Spool valve	Aluminum, NBR	
3	Piston	Resin	

Replacement Parts

4	Pilot valve assembly	V118□□□ A B E	□: Coil rated voltage Example) 24 VDC: 5 A: With light (For A side) B: With light (For B side) E: Without light (A/B side common)
		•Coil type Nil Standard (0.95 W) Y Low wattage type (0.4 W)	

SV
SYJ
SZ
VF
VP4
VQ 1/2
VQ 4/5
VQC 1/2
VQC 4/5
VQZ
SQ
VFS
VFR
VQ7

VQ5000 Series

Exploded View of Manifold

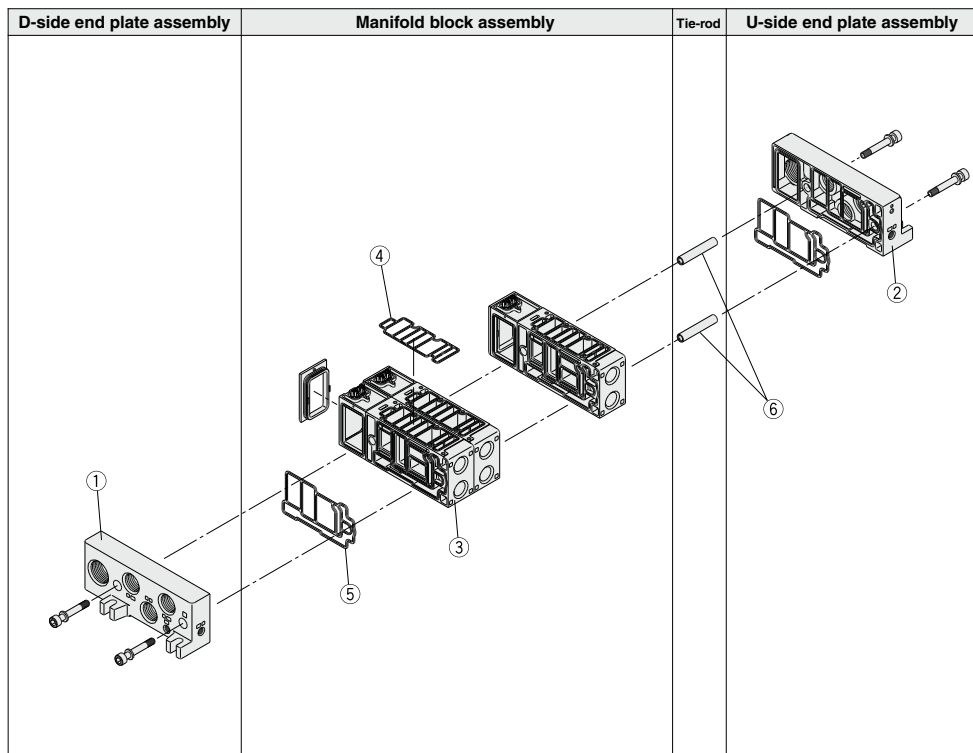

Note) The electrical entry cannot be changed.

Figure shows a plug-in type.

D-Side End Plate Assembly

1. D-side end plate assembly part no. (For F, L, S, T & T1 kits)

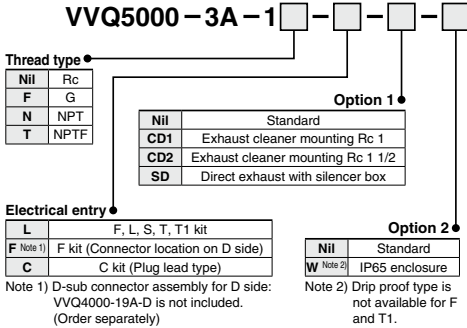

D-sub connector assembly

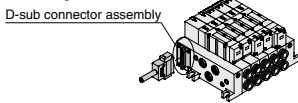

Manifold Block Assembly

3. Manifold block assembly part no. (Including ④ and ⑤)

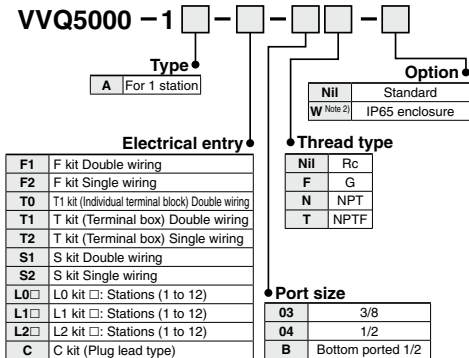

Note 1) Tie-rods (2 pcs.) and lead wire assembly for station addition included.

Note 2) Drip proof type is not available for F and T1.

U-Side End Plate Assembly

2. U-side end plate assembly part no. (For F, L, S, T & T1 kits)

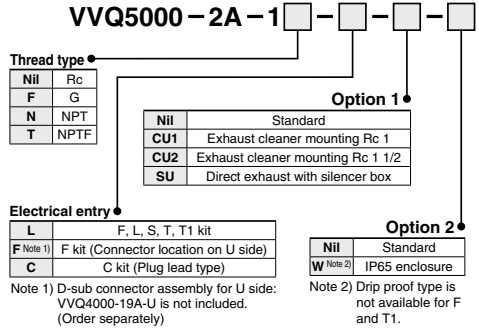

Manifold Block Replacement Parts

Replacement Parts

No.	Part no.	Description	Material	Qty
④	VVQ5000-80A-1	Gasket	HNBR	10
⑤	VVQ5000-80A-2	Gasket	HNBR	10

Note) Spare parts consist of sets containing 10 pcs. each.

6. Tie-rods part no. (2 pcs.)



Note) When eliminating manifold stations, order this separately. When increasing manifold stations, it is not necessary to order since tie-rods are included in the manifold block assembly.

Housing Assembly and SI Unit

Kit type	Model symbol	Part no.		Description
		For U side mounting	For D side mounting	
S (Serial transmission unit)	H	EX123U-SUH1	EX123D-SUH1	NKE Corp.: Fieldbus H System
	Q	EX124U-SDN1	EX124D-SDN1	DeviceNet™
	R1	EX124U-SCS1	EX124D-SCS1	OMRON Corp.: CompoBus/S (16 output points, 2 power supply systems)
	R2	EX124U-SCS2	EX124D-SCS2	OMRON Corp.: CompoBus/S (8 output points, 2 power supply systems)
	V	EX124U-SMJ1	EX124D-SMJ1	Mitsubishi Electric Corporation: CC-Link System (2 power supply systems)
T (Terminal block box kit)	—	VVQ5000-70A-U (-W)	VVQ5000-70A-D (-W)	—

VQ5000 Series

List of Valves, Options, and Mounting Bolts

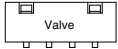
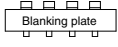
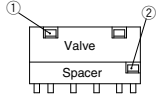
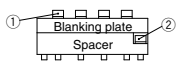
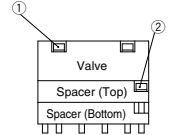
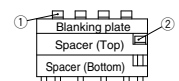
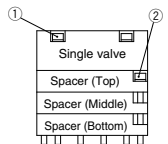
Number of options	Valve and options	Bolt part no.	Qty (pcs)	Note	Option mounting diagram
0	Single valve	AXT632-25-4 (M4 x 50)	4		
	Blanking plate (VVQ5000-10A- $\frac{1}{5}$)	AXT632-25-8 (M4 x 17)	4	For manifold	
1	Valve + Individual SUP spacer (VVQ5000-P- $\frac{1}{5}$ - $\frac{03}{04}$)	① AXT632-25-5 (M4 x 82)	4	For manifold	
		② AXT632-25-10 (M4 x 34)	2		
	Valve + Individual EXH spacer (VVQ5000-R- $\frac{1}{5}$ - $\frac{03}{04}$)	① AXT632-25-5 (M4 x 82)	4	For manifold	
		② AXT632-25-10 (M4 x 34)	2		
	Valve + Restrictor spacer (VVQ5000-R- $\frac{1}{5}$)	① AXT632-25-5 (M4 x 82)	4	Not necessary when mounting the sub-plate.	
		② AXT632-25-10 (M4 x 34)	2		
	Valve + Release valve spacer (VVQ5000-24A- $\frac{1}{5}$ D)	① AXT632-25-5 (M4 x 82)	4	For manifold	
		② AXT632-25-10 (M4 x 34)	2		
	Valve + Double check spacer with residual pressure exhaust (VVQ5000-25A- $\frac{1}{5}$)	① AXT632-25-6 (M4 x 114)	4	Not necessary when mounting the sub-plate.	
		② AXT632-66-1 (M4 x 64)	2		
Valve + SUP stop valve spacer (VVQ5000-20A- $\frac{1}{5}$)	① AXT632-25-5 (M4 x 82)	4	Not necessary when mounting the sub-plate.		
	② AXT632-25-10 (M4 x 34)	2			
Valve + Interface regulator (ARBQ5000-00- $\frac{A}{C}$ - $\frac{1}{5}$)	① AXT632-25-6 (M4 x 114)	4	Not necessary when mounting the sub-plate.		
	② AXT632-66-1 (M4 x 64)	2			
	Blanking plate + SUP stop valve (Top) (Bottom)	① AXT632-25-4 (M4 x 50)	4	For manifold	
		② AXT632-25-10 (M4 x 34)	2		
2	Valve + Individual SUP + Individual EXH (Top) (Bottom) (Top)	① AXT632-25-6 (M4 x 114)	4	For manifold	
		② AXT632-25-11 (M4 x 66)	2		
	Valve + Restrictor + Individual SUP or Individual EXH (Top) (Bottom) (Top) (Bottom)	① AXT632-25-6 (M4 x 114)	4	For manifold * The individual EXH cannot be mounted on the top.	
		② AXT632-25-11 (M4 x 66)	2		
	Valve + SUP stop valve + Individual SUP, Individual EXH or Restrictor (Bottom)	① AXT632-25-6 (M4 x 114)	4	For manifold	
		② AXT632-25-11 (M4 x 66)	2		
	Valve + Double check spacer with + Individual SUP or residual pressure exhaust + Individual EXH (Top) (Bottom)	① AXT632-25-7 (M4 x 146)	4	For manifold	
		② AXT632-66-2 (M4 x 96)	2		
	Valve + Interface regulator + Double check spacer with residual pressure exhaust (Top) (Bottom)	① AXT632-25-14 (M4 x 178)	4	For manifold	
		② AXT632-66-3 (M4 x 128)	2		
Valve + Interface regulator + Individual SUP, Individual EXH or Restrictor (Bottom)	① AXT632-25-7 (M4 x 146)	4	For manifold * The individual EXH and throttle valve can be mounted on the top.		
	② AXT632-66-2 (M4 x 96)	2			
	Blanking + SUP stop + Individual valve valve SUP (Top) (Bottom)	① AXT632-25-5 (M4 x 82)	4	For manifold	
		② AXT632-25-11 (M4 x 66)	2		
3	Valve + SUP stop valve (Top) + Individual SUP (Middle, Bottom) + Individual EXH (Middle, Bottom)	① AXT632-25-7 (M4 x 146)	4	For manifold	
		② AXT632-25-12 (M4 x 98)	2		
	Valve + Double check spacer with residual pressure exhaust (Top) + Individual SUP (Middle, Bottom) + Individual EXH (Middle, Bottom)	① AXT632-25-14 (M4 x 178)	4	For manifold	
		② AXT632-66-3 (M4 x 128)	2		
Valve + Spacer (Top): Interface regulator Spacer (Middle): Individual SUP or Individual EXH*/Restrictor Spacer (Bottom): Restrictor*/Individual SUP or Individual EXH*	① AXT632-25-14 (M4 x 178)	4	For manifold * The individual EXH and throttle valve can be mounted on the top.		
	② AXT632-66-3 (M4 x 128)	2			

Note 1) When the SUP stop valve and individual SUP are mounted, the stop valve is mounted on the top of the individual SUP.



VQ4000/5000 Series Specific Product Precautions 1

Be sure to read this before handling the products.
Refer to back page 50 for Safety Instructions and pages 3 to 9 for 3/4/5 Port Solenoid Valve Precautions.

Continuous Duty

Warning

When the product is continuously energized for a long period of time (10 minutes or longer), select the low wattage type (DC specification). The AC type cannot be continuously energized for 10 minutes or longer. If anything is unclear, please contact SMC.

Manual Override

Warning

Since connected equipment will operate when the manual override is activated, confirm that conditions are safe prior to activation.

Push type (Tool required)

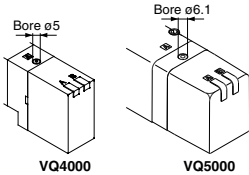

Push down the manual override button with a small screwdriver, etc., until it stops. The manual override will return when released.

Locking type (Tool required)

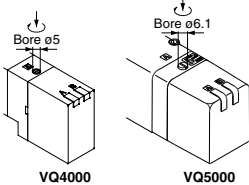

Push down the manual override button with a small flat head screwdriver until it stops, and turn it clockwise 90° to lock it. Turn it counterclockwise to release it.

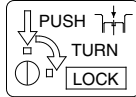

Locking type (Manual)

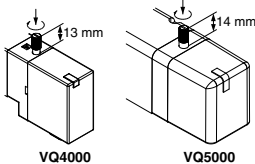

Push down the manual override button with a small flat head screwdriver or with your fingers until it stops. Turn it clockwise by 90° to lock it. Turn it counterclockwise to release it.

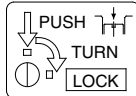

Caution
Do not apply excessive torque when turning the locking type manual override. (0.1 N·m or less)

Valve Mounting

Caution

After confirming that the gasket is installed correctly, securely tighten the mounting screws according to the tightening torque shown below.

VQ4000

Proper tightening torque [N·m]
0.8 to 1.2

VQ5000

Proper tightening torque [N·m]
1 to 1.8

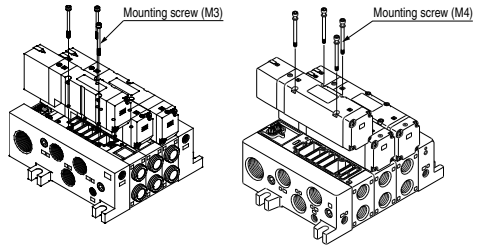

Replacement of One-touch Fittings/VQ4000

Caution

Cylinder port fittings are available in cassette type and can be replaced easily. Fittings are secured with a retaining clip that is inserted from the top side of the valve. After removing the valve, remove the clip with a flat head screwdriver to replace the fittings. To mount a fitting, insert the fitting assembly until it stops and reinsert the retaining clip to its designated position.

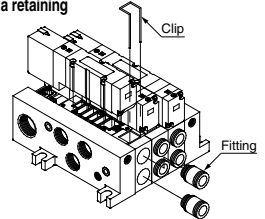

Lead Wire Connection

Caution

Plug-in sub-plate (With terminal block)

- If the junction cover ① of the sub-plate is removed, you can see the plug-in type terminal block ② mounted inside the sub-plate.
- The terminal block is marked as follows. Connect wiring to each of the power supply terminals.

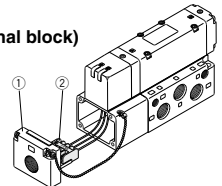

Terminal block marking	A	COM	B	T
Model VQ $\frac{4}{5}$ 10 $\frac{0}{1}$	A side	COM	—	—
VQ $\frac{4}{5}$ 20 $\frac{0}{1}$	A side	COM	B side	—
VQ $\frac{4}{5}$ 30 $\frac{0}{1}$	A side	COM	B side	—

Note 1) There is no polarity. It can also be used as -COM.
Note 2) The sub-plate is double wired even for the VQ $\frac{4}{5}$ 10 $\frac{0}{1}$.

- Applicable terminal: 1.25-3s, 1.25Y-3, 1.25Y-3N, 1.25Y-3.5

SV
SYJ
SZ
VF
VP4
VQ 1/2
VQ 4/5
VQC 1/2
VQC 4/5
VQZ
SQ
VFS
VFR
VQ7



VQ4000/5000 Series Specific Product Precautions 2

Be sure to read this before handling the products.
Refer to back page 50 for Safety Instructions and pages 3 to 9 for 3/4/5 Port Solenoid Valve Precautions.

Lead Wire Connection

⚠ Caution

Plug lead: Grommet type

Make connections to each corresponding wire.

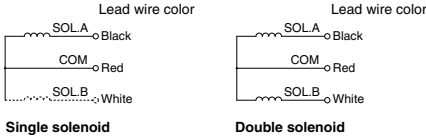

	Single solenoid	Double solenoid
Standard	Black: A side solenoid Red: COM	Black: A side solenoid Red: COM White: B side solenoid
IP65 enclosure	Black: A side solenoid Red: COM White: B side solenoid (Not used for single solenoid) Green: (Not used for single or double.)	

Note) There is no polarity. It can also be used as -COM.

Installation and Removal of Light Cover

⚠ Caution

Installation/Removal of light cover (VQ4000)

• Removal

Open the cover by inserting a small flat head screwdriver into the slot on the side of the pilot assembly (see drawing below), lift the cover out about 1 mm and then pull off. If it is pulled off at an angle, the pilot valve may be damaged or the protective O-ring may be scratched.

• Installation

Place the cover straight over the pilot assembly so that the pilot valve is not touched, and push it until the cover hook locks without twisting the protective O-ring. (When pushed in, the hook opens and locks automatically.)

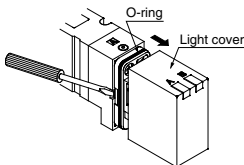

Installation and Removal of Light Cover

⚠ Caution

Installation/Removal of light cover (VQ5000)

• Removal

To remove the pilot cover pull it straight off. If it is pulled off at an angle, the pilot valve may be damaged or the protective O-ring may be scratched.

• Installation

Place the cover straight over the pilot assembly so that the pilot valve is not touched, and push it until the cover hook locks without twisting the protective O-ring. (When pushed in, the hook opens and locks automatically.)

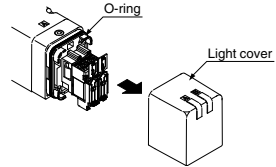

Replacement of Pilot Valve

⚠ Caution

• Removal

Remove the mounting screw that holds the pilot valve using a small screwdriver.

• Installation

After confirming the gasket is correctly placed under the valve, securely tighten the bolts with the proper torque shown in the table below.

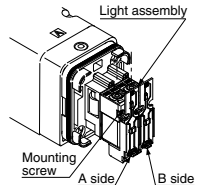

Proper tightening torque [N·m]

0.1 to 0.13

Note) The light circuit boards: A side is orange and the B side is green. It must be mounted on the pilot valve in accordance with the mounting indicators.

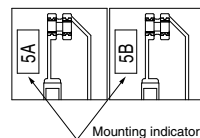



VQ4000/5000 Series Specific Product Precautions 3

Be sure to read this before handling the products.
Refer to back page 50 for Safety Instructions and pages 3 to 9 for 3/4/5 Port Solenoid Valve Precautions.

Plug Lead Type

Attaching and detaching connectors

- To attach a connector, hold the lever and connector unit between your fingers and insert straight onto the pins of the solenoid valve so that the lever's pawl is pushed into the groove and locks.
- To detach a connector, remove the pawl from the groove by pushing the lever downward with your thumb, and pull the connector straight out.

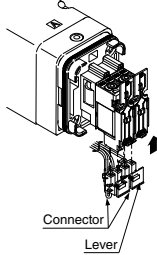

Note) Do not pull on the lead wires with excessive force. This can cause faulty and/or broken contacts.

Enclosure IP65

⚠ Caution

Wires, cables, connectors, etc. used for models conforming to IP65 should also have enclosures equivalent to or stricter rating than IP65.

How to Calculate the Flow Rate

For obtaining the flow rate, refer to flont matter.

Internal Wiring Specifications

⚠ Caution

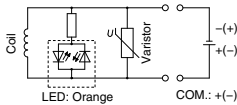

DC: Single

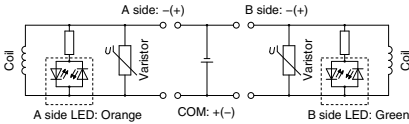

DC: Double

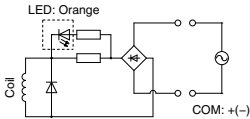

AC: Single

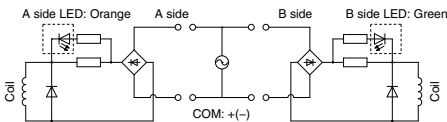

AC: Double

Note) For DC, coil surge voltage generated when OFF is about -60 V. Please contact SMC separately for further suppression of the coil surge voltage.

SV

SYJ

SZ

VF

VP4

VQ
1/2

VQ
4/5

VQC
1/2

VQC
4/5

VQZ

SQ

VFS

VFR

VQ7