

5 Port Air Operated Valve

VPA4□50/4□70 Series

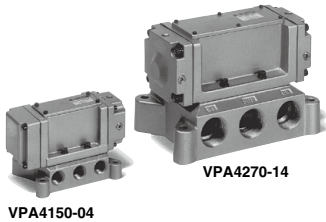

Symbol

2 position single
VPA4150/4170

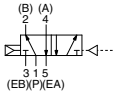

3 position closed center
VPA4350

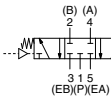

2 position double
VPA4250/4270

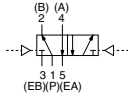

3 position exhaust center
VPA4450

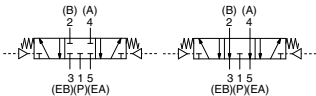

How to Order

VPA4 1 5 0 - 10 - □

VP 5 port
Air operated valve

Function

1	2 position single pilot
2	2 position double pilot
3	3 position closed center
4	3 position exhaust center

Note) 3 position is not available on VPA4□70 series.

Body size

5	3/4 standard
7	1 1/4 standard

Piping

0	Side ported
1*	Bottom ported
4	W/o sub-plate

* Semi-standard

Thread type

NH	Rc
F	G
N	NPT
T	NPTF

Port size

Symbol	Port size	Applicable valve model
00	Without sub-plate	VPA4□54, 4□74
03	3/8 (10A)	VPA4□5□
04	1/2 (15A)	
06	3/4 (20A)	
10*	1 (25A)	VPA4□7□
12	1 1/4 (32A)	
14	1 1/2 (40A)	

* Side piping only

Specifications

Fluid	Air
Operating pressure range (MPa)	0.2 to 0.9
Pilot pressure range (MPa)	Refer to the pilot pressure graph shown in below.
Ambient and fluid temperature (°C)	0 to 60
Lubrication ⁽¹⁾	Required (Use turbine oil Class 1 ISO VG32.)
Mounting orientation	Free
Impact/Vibration resistance (m/s ²) ⁽²⁾	150/50

Note 1) Use turbine oil Class 1 (ISO VG32).

Note 2) Impact resistance: No malfunction from test using drop impact tester, to axis and right angle directions of main valve, each one time when pilot signal is ON and OFF. (Value in the initial stage)

Vibration resistance: No malfunction from test with 45 to 1000 Hz one sweep, to axis and right angle direction of main valve, each one time when pilot signal ON and OFF. (Value in the initial stage)

Pilot Pressure Range

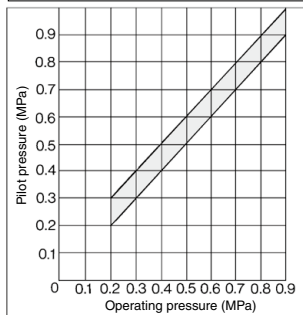

⚠ Precautions

Be sure to read this before handling the products. Refer to back page 50 for Safety Instructions and pages 3 to 9 for 3/4/5 Port Solenoid Valve Precautions.

⚠ Caution

- Lubrication**
Use turbine oil Class 1 (ISO VG32).
- Refer to page 363 regarding piping, air quality, operating condition and 3 position closed center.

5 Port Air Operated Valve **VPA4**□50/4□70 Series

Flow Rate Characteristics/Weight

Function	Valve model	Port size	Flow rate characteristics						Weight (kg)	
			1→4/2(P→A/B)			4/2→5/3(A/B→EA/EB)				
			C[dm ³ /(s·bar)]	b	Cv	C[dm ³ /(s·bar)]	b	Cv		
2 position	Single	VPA4150	3/8	15	0.22	3.6	16	0.33	4.5	1.9
			1/2	17	0.15	4.0	19	0.28	5.1	
			3/4	21	0.13	5.2	21	0.28	5.6	
	Double	VPA4250	3/8	15	0.22	3.6	16	0.33	4.5	1.9
			1/2	17	0.15	4.0	19	0.28	5.1	
			3/4	21	0.13	5.2	21	0.28	5.6	
3 position	Closed center	VPA4350	3/8	16	0.28	4.0	15	0.29	4.0	2.5
			1/2	18	0.27	4.7	18	0.23	4.5	
			3/4	22	0.19	5.3	20	0.23	5.0	
	Exhaust center	VPA4450	3/8	16	0.28	3.9	16(15)	0.29(0.28)	4.2(4.0)	2.5
			1/2	18	0.24	4.5	19(16)	0.24(0.27)	4.8(4.5)	
			3/4	22	0.15	5.1	22(18)	0.23(0.30)	5.5(4.8)	

Note) (): Normal position

Function	Valve model	Port size	Effective area mm ²	Weight (kg)		
2 position	Single	VPA4150	1	120	2.7	
		VPA4170	1 1/4	280	8.8	
			1 1/2	300		
	Double	VPA4250	1	120	2.7	
			VPA4270	1 1/4	280	8.8
				1 1/2	300	
3 position	Closed center	VPA4350	1	110	3.3	
	Exhaust center	VPA4450	1	110	3.3	

Replacement Parts

Description	Part no.	Note
Sub-plate	AXT021-1-1- □	Aluminum alloy
	AXT021-1-2- □	
	DXT131-15P-06 □	
	DXT131-15P-10 □	
	DXT132-15-2P-12 □	
	DXT132-15-2P-14 □	
Gasket	XT021-9	VPA4 □ 50
	DXT132-16	VPA4 □ 70
Hexagon socket head screw	M6 x 25 with washer	VPA4 □ 50
	M8 x 35	VPA4 □ 70

- SYA
- SYJA
- VZA
- VFA
- VFRA
- VPA4
- SYJA
- VZA
- VTA
- VGA
- VPA
- VPA3

VPA4□50 Series

Dimensions

VPA4150-□-□

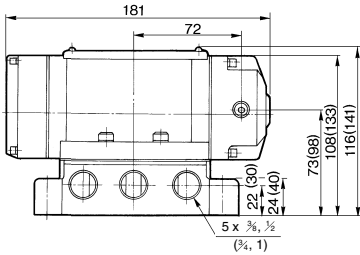
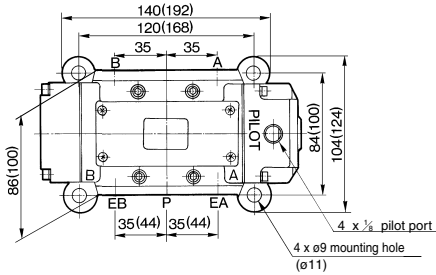

Bottom ported

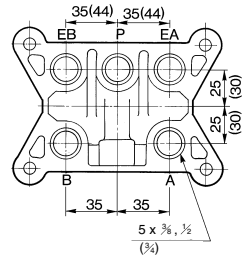

(): Value for Rc $\frac{3}{4}$, Rc 1

VPA4250-□-□, VPA4350-□-□, VPA4450-□-□

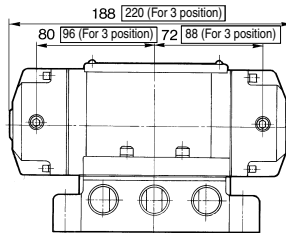
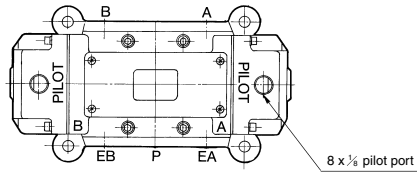

Dimensions

VPA4170- $\frac{12}{14}$ -□

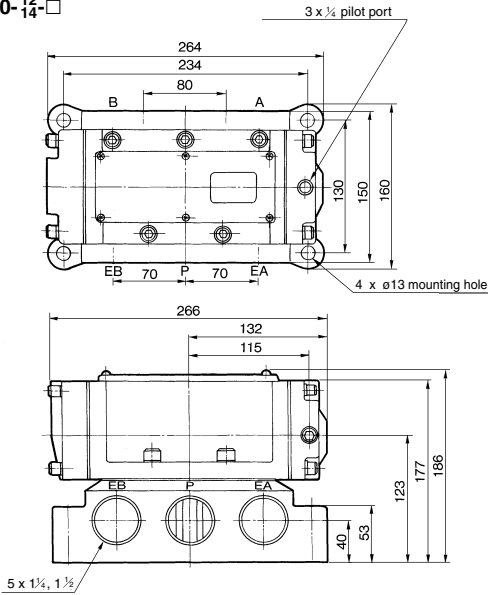

Bottom ported

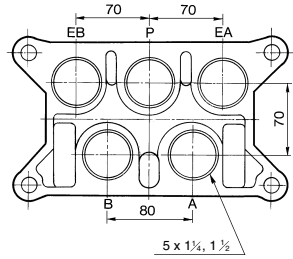

SYA
SYJA
VZA
VFA
VFRA
VPA4
SYJA
VZA
VTA
VGA
VPA
VPA3

VPA4270- $\frac{12}{14}$ -□

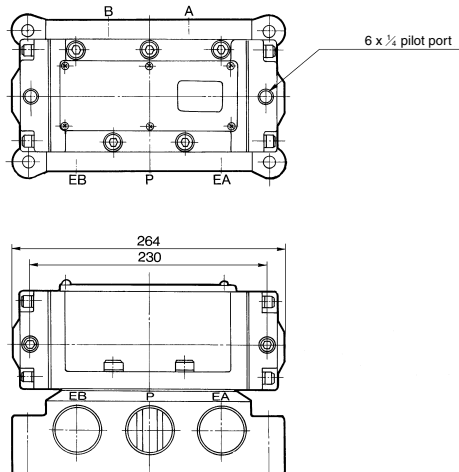

VPA4□50 Series

Manifold Specifications

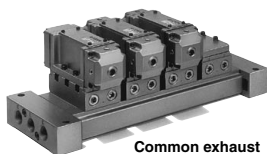

Common exhaust

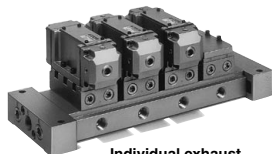

Individual exhaust

Specifications

Manifold type	B mount
Exhaust type	Common exhaust, Individual exhaust ⁽¹⁾
Supply type	Common supply port
Stations	Max. 10 stations (VVPA460: Max. 8 stations) ⁽²⁾

Note 1) When valves are closed with diaphragm, back pressure may cause malfunction. Use individual exhaust to prevent such a problem.

Note 2) In the case of more than 4 stations, supply air to both sides of supply port and exhaust air from both sides.

Simultaneous Operation with Manifold Valves

Note) Pressure drop will occur by simultaneously using manifold valves.

Model

Base model	Exhaust type	Port size			Applicable valve model
		P	A, B	E	
VVPA450	Common	3/4	1/2, 3/4	3/4	VPA4154-00 VPA4254-00 VPA4354-00 VPA4454-00
	Individual				
VVPA460	Common	1	3/4, 1	1	
	Individual				

Option

Blanking plate assembly	XT038N-4A	With Gasket, Bolt
-------------------------	-----------	-------------------

Caution

Manifold specifications are not available for VPA4□70 series.

How to Order

VVPA4 5 0 - 04 1 - 04 - []

VP 5 port Air operated manifold

Base size

5	3/4
6	1

Piping

Symbol	P	A, B	E
0	Side	Side	Side
1*	Side	Bottom ⁽¹⁾	Side
9*	Other		

Note 1) Size of A, B port bottom ported: 3/8, 1/2
* Semi-standard

Thread type

NH	Rc
F	G
N	NPT
T	NPTF

A, B Port size

Symbol	Port size	VVPA450	VVPA460
04	1/2	●	—
06	3/4	●	●
10	1	—	●
M ⁽²⁾	Mixed	●	●

Note 2) In the case of mixed specifications, indicate M and specify port location separately on a manifold specification sheet.

Base specifications

1	Common exhaust
2	Individual exhaust

Stations

02	2 stations
:	:
10	10 stations

How to Order Manifold Assembly

To order valves and blanking plate assembly mounted onto the manifold, list valves and blanking plate assembly with manifold base part number.

EX) Base: 6 stations, common EXH, A & B port 1/2
VVPA450-061-04 1 pc.
 +VPA4154-00 3 pcs.
 +VPA4254-00 2 pcs.
 +XT038N-4A 1 pc.

To order valves and options mounted onto the manifold at the factory, list the valve/option with an asterisk (*) in front of each part number.

5 Port Air Operated Valve **VPA4□50 Series**

Dimensions

Common EXH: **VVPA450-Station 1-Port size-** □
VVPA460-Station 1-Port size- □

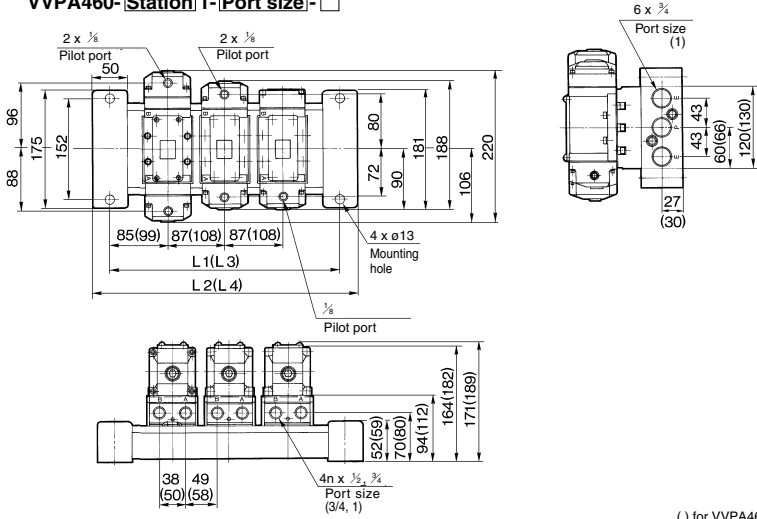

() for VVPA460

Individual EXH: **VVPA450-Station 2-Port size-** □
VVPA460-Station 2-Port size- □

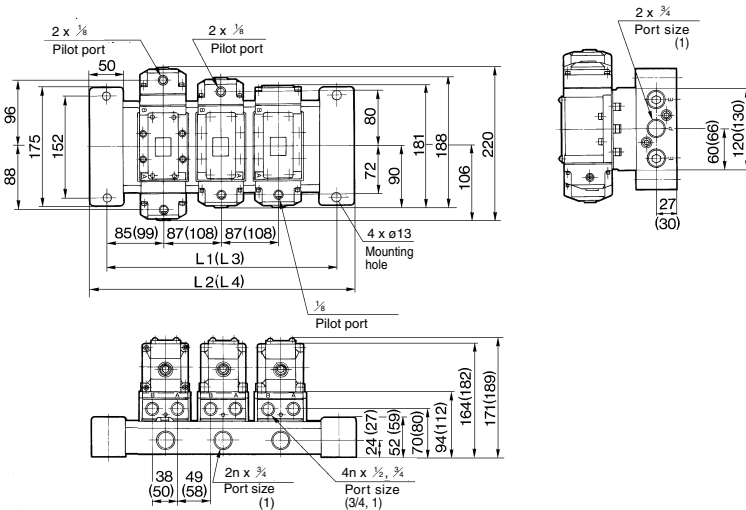

() for VVPA460

L Dimension

Model	n: Station										Formula
	L ₁	2	3	4	5	6	7	8	9	10	
VVPA450	L ₁	257	344	431	518	605	692	779	866	953	L ₁ =87 × n+83
	L ₂	307	394	481	568	655	742	829	916	1003	L ₂ =87 × n+133
VVPA460	L ₃	306	414	522	630	738	846	954	—	—	L ₃ =108 × n+90
	L ₄	356	464	572	680	788	896	1004	—	—	L ₄ =108 × n+140