

3 Port Solenoid Valve

VP300/500/700 Series



Selectable power consumption!

0.4 w

[Low wattage specification]

0.55 w 1.55* w

[With power saving circuit]

[Standard]

[Starting 1.55 W, Holding 0.55 W] * Current model: 2.0 W With DC light

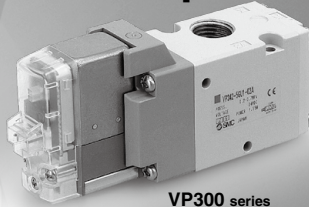

VP300 series

Low wattage specification added

* VP300/500

P.1278

Power consumption **0.35 w** (Without light)
0.4 w (With light)



Power consumption is reduced by power saving circuit.

Power consumption is decreased by approx. 1/3 by reducing the wattage required to hold the valve in an energized state. (Effective energizing time is over 40 ms at 24 VDC.) Refer to electrical power waveform as shown below.

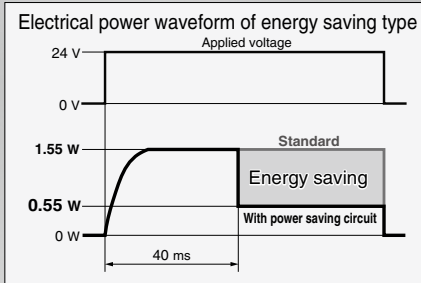

■ Built-in full-wave rectifier (AC)

● Noise reduction

Noise is considerably reduced by changing it to DC mode with a full-wave rectifier.

● Reduced apparent power

Current 5.6 VA → **1.55 VA** [Standard]

■ Built-in strainer in the pilot valve

Unexpected troubles due to foreign matter can be prevented.

Note) Be sure to mount an air filter on the inlet side.

Rubber material: HNBR
Ozone-resistant specification
The pilot valve poppet is made of FKM.

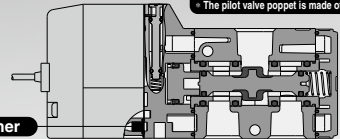

Strainer

SYJ

VQZ

VP

VG

VP3

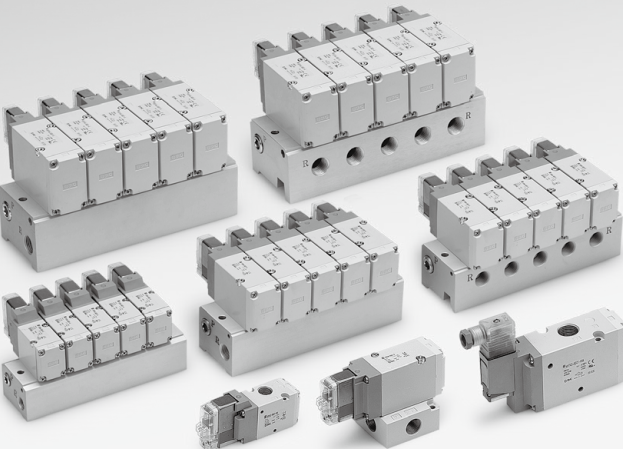

Air Operated Valve

















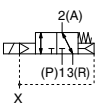

VPA300/500/700 Series

P.1555

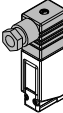

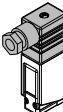
Model Selection by Operating Conditions ①

Solenoid Valve: Single Unit

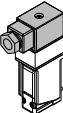
	Series	Sonic conductance C [dm ² /(s·bar)]	Type of actuation	Port size	Voltage	Electrical entry	Light/surge voltage suppressor	Manual override
Body ported	VP300 	4.2	Internal pilot N.C. 	1/8 1/4		Grommet 		
	VP500 	8.9	N.O. 	1/4 3/8		L-type plug connector 		Non-locking push type 
	VP700 	15.3	External pilot N.C./N.O. 	3/8 1/2	12 VDC 24 VDC 24 VAC 100 VAC	M-type plug connector 	DC ■ With surge voltage suppressor ■ With light/surge voltage suppressor ■ With surge voltage suppressor (Non-polar) ■ With light/surge voltage suppressor (Non-polar)	Push-turn locking slotted type 
Base mounted	VP300 	3.8	Internal pilot N.C. 	1/8 1/4	200 VAC 110 VAC 220 VAC 240 VAC	DIN terminal 	AC ■ With light/surge voltage suppressor	
	VP500 	8.8	N.O. 	1/4 3/8		DIN (EN1753 01-803) terminal 		Push-turn locking lever type 
	VP700 	15.0	External pilot N.C. 	3/8 1/2		Conduit terminal 		



P. 1264

P. 1271

Low wattage specification From page 1278 Power consumption: 0.35 W (Without light) 0.4 W (With light)

Model Selection by Operating Conditions ②

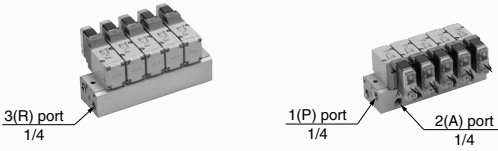
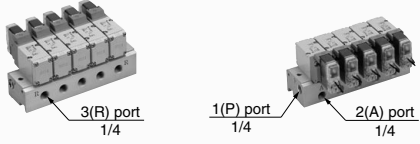
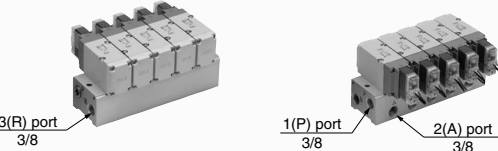
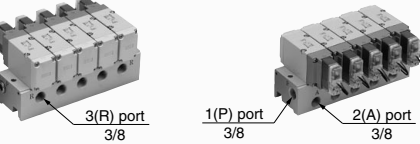
Solenoid Valve: Manifold

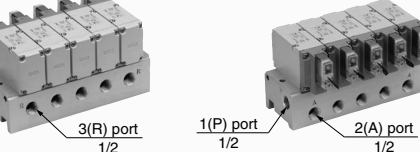
Series	EXH port type	Manifold base model	Applicable stations <small>(Note)</small>
VP300	Common EXH	VV3P3-41 	2 to 20 stations
	Individual EXH	VV3P3-42 	
VP500	Common EXH	VV3P5-41 	2 to 20 stations
	Individual EXH	VV3P5-42 	
VP700	Common EXH	VV3P7-41 	2 to 20 stations
	Individual EXH	VV3P7-42 	

Solenoid valve
Base mounted

P. 1282

SYJ
VQZ
VP
VG
VP3

(Note) Supply pressure to 1(P) ports and exhaust air from 3(R) ports on both sides for 10 stations or more.

Rubber Seal 3 Port/Pilot Poppet Type Body Ported/Single Unit VP300/500/700 Series

How to Order



Note) Only DIN and conduit terminal types are available for AC mode.
Refer to the electrical entry for details.



* See the table below.

Note) Pressure specifications: 0.7 MPa, DC or 24 VAC only
Only applies to X500 and X505 for made-to-order specifications

Body ported

VP **3** **4** **2** **5** **G** **1** **01** **A**

Series

3	VP300
5	VP500
7	VP700

Pilot type

Nil	Internal pilot	●
R	External pilot	●

UL-compliant

Pressure specification

Nil	Standard (0.7 MPa)	●
K	High-pressure type (1.0 MPa)	—

UL-compliant

Coil specification

Nil	Standard
T	With power saving circuit (DC only)

Note) Be sure to select the power saving circuit type when it is continuously energized for a long time.
(Refer to page 1296 for details.)

* T type is only available for DC mode.
When T is selected, only Z type of light/surge voltage suppressor is available.

(Note that when the electrical entry of DIN terminal type without connector is selected, only DOS and YOS are available.)

Rated voltage

DC	UL-compliant	
5	24 VDC	●
6	12 VDC	●

AC (50/60 Hz)

1	100 VAC	—
2	200 VAC	—
3	110 VAC [115 VAC]	—
4	220 VAC [230 VAC]	—
7	240 VAC	—
B	24 VAC	●

Note) For triac output, refer to the made-to-order specifications (X600).

Thread type

Nil	Rc
F	G
N	NPT
T	NPTF

Bracket

Nil	Without bracket
F	With bracket

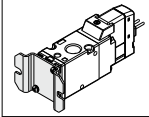

Type of actuation

A	N.C. (Normally closed)
B	N.O. (Normally open)

Port size

Symbol	Port size	VP300	VP500	VP700
01	1/8	○	—	—
02	1/4	○	○	—
03	3/8	—	○	○
04	1/2	—	—	○

Made to Order

Nil	—	●
X500	Pilot exhaust port with piping thread (M3) specification (Refer to page 1291).	●
X505	Interchangeable specification with the previous valve mounting hole pitch type (Refer to page 1291).	●
X600	Triac output specification (Refer to page 1291).	—

Manual override

Nil: Non-locking push type	D: Push-turn locking slotted type	E: Push-turn locking lever type

Electrical entry

Grommet	L-type plug connector	M-type plug connector	DIN terminal	DIN (EN175301-803) terminal	Conduit terminal
G: Lead wire length 300 mm H: Lead wire length 600 mm	L: With lead wire (length 300 mm)	M: With lead wire (length 300 mm)	D: With connector	Y: With connector	T: Conduit terminal
G: Lead wire length 300 mm H: Lead wire length 600 mm DC Without light/surge voltage suppressor	LN: Without lead wire	MN: Without lead wire	DO: Without connector	YO: Without connector	
LO: Without connector	MO: Without connector				

CE-compliant	DC	CE	CE	CE	CE
	AC 100V	—	—	—	—

* LN and MN types are with 2 sockets.

* Refer to page 1294 when different length of lead wire for L/M-type plug connector is required.

* Refer to page 1295 for details on the DIN (EN175301-803) terminal.

Note) With the same specifications as the DC type, all lead wire entries for the 24 VAC type are CE marking compliant.

Light/surge voltage suppressor

Nil	Without light/surge voltage suppressor	○	○
S	With surge voltage suppressor	○	—(Note)
Z	With light/surge voltage suppressor	○	○
R	With surge voltage suppressor (Non-polar)	○	—
U	With light/surge voltage suppressor (Non-polar)	○	—

Note) There is no S option for AC mode, since a rectifier prevents surge voltage generation.

* In the DIN terminal type, since a light is installed in the connector, DOZ, DOU, YOZ, YOU are not available.

Caution

When using the surge voltage suppressor type, residual voltage will remain. Refer to page 1300 for details.

Pilot Poppet Type Body Ported/Single Unit **VP300/500/700 Series**

Low power consumption 1.5 W (DC)

Possible to use as either a selector or divider valve

Possible to change from N.C. to N.O.

• Refer to page 1300 for changing the type of actuation.

Possible to use in vacuum applications

Up to -100 kPa



VP300 Series



VP500 Series



VP700 Series

External Pilot

Use external pilot type in the following cases:

- For vacuum or for low pressure 0.2 MPa or less
- Since this valve has slight air leakage, it can not be used for holding vacuum (including positive pressure holding) in the pressure container.
- When having P port downsized in diameter
- When using A port as the atmospheric releasing port, e.g. air blow



Made to Order

(Refer to page 1291 for details.)

X500	Pilot exhaust port with piping thread (M3) specification
X505	Interchangeable specification with the previous valve mounting hole pitch type
X600	Triac output specification

Specifications

Fluid		Air
Type of actuation		N.C. or N.O. (Convertible)
Internal pilot Operating pressure range (MPa)	Standard	0.2 to 0.7
	High-pressure type	0.2 to 1.0
External pilot Operating pressure range (MPa)	Standard	-100 kPa to 0.7
	High-pressure type	-100 kPa to 1.0
Pilot pressure range		Same as operating pressure (Min. 0.2 MPa)
Ambient and fluid temperature (°C)		-10 to 50 (No freezing)
Max. operating frequency (Hz)		5
Manual override		Non-locking push type Push-turn locking slotted type Push-turn locking lever type
Pilot exhaust type		Individual exhaust
Lubrication		Not required
Mounting orientation		Unrestricted
Impact/Vibration resistance (m/s ²) ^{Note}		300/50
Enclosure		Dust-tight (IP65 for D, Y, T)

Note) Impact resistance: No malfunction occurred when it is tested in the axial direction and at the right angles to the main valve and armature in both energized and de-energized states every once for each condition. (Values at the initial period)

Vibration resistance: No malfunction occurred in a one-sweep test between 45 and 2000 Hz. Test was performed at both energized and de-energized states in the axial direction and at the right angles to the main valve and armature. (Values at the initial period)

Solenoid Specifications

Electrical entry		Grommet (G), (H) L-type plug connector (L) M-type plug connector (M)	DIN terminal (D) DIN (EN175301-803) terminal (Y) Conduit terminal (T)
		G, H, L, M	D, Y, T
Coil rated voltage (V)	DC	24, 12	
	AC (50/60 Hz)	24, 100, 110, 200, 220, 240	
Allowable voltage fluctuation ±10% of rated voltage*			
Power consumption (W)	DC	Standard	1.5 (With light: 1.55)
		With power saving circuit	0.55 ^{Note)} (With light only) [Starting 1.55, Holding 0.55]
Apparent power (VA) [†]	AC	24 V	1.5 (With light: 1.55)
		100 V	1.5 (With light: 1.75)
		110 V [115 V]	0.75 ^{Note)} (With light only) [Starting 1.75, Holding 0.75]
		200 V	1.55 (With light: 1.65)
		220 V [230 V]	1.55 (With light: 1.7)
		240 V	
Surge voltage suppressor		Diode (Non-polar type: Varistor)	
Indicator light		LED (Neon bulb is used for AC mode of D, Y, T.)	

* It is in common between 110 VAC and 115 VAC, and between 220 VAC and 230 VAC.

* Allowable voltage fluctuation is -15% to +5% of the rated voltage for 115 VAC or 230 VAC.

* Since voltage drops due to the internal circuit in S, Z, T types (with power saving circuit), the allowable voltage fluctuation should be within the following range.

24 VDC: -7% to +10%

12 VDC: -4% to +10%

Note) Refer to page 1296 for details.

Response Time

Model	Pressure specifications	Response time ms (at 0.5 MPa)			
		Without light/surge voltage suppressor	With light/surge voltage suppressor		AC
		S, Z type	R, U type		
VP342	Standard (0.2 to 0.7)	13 or less	38 or less	16 or less	38 or less
	High-pressure type (0.2 to 1.0)	17 or less	42 or less	20 or less	42 or less
VP542	Standard (0.2 to 0.7)	14 or less	39 or less	17 or less	39 or less
	High-pressure type (0.2 to 1.0)	18 or less	43 or less	21 or less	43 or less
VP742	Standard (0.2 to 0.7)	19 or less	44 or less	22 or less	44 or less
	High-pressure type (0.2 to 1.0)	22 or less	47 or less	25 or less	47 or less

Note) Based on dynamic performance test, JIS B 8419: 2010. (Coil temperature: 20°C, at rated voltage)

VP300/500/700 Series

Flow Rate Characteristics/Weight

Model	Port size	1 ↔ 2 (P ↔ A)			2 ↔ 3 (A ↔ R)			Weight (g) ^{Note)}	
		C [dm ³ /(s·bar)]	b	Cv	C [dm ³ /(s·bar)]	b	Cv	Grommet	DIN terminal
VP342	1/8	3.5	0.26	0.8	3.6	0.26	0.9	149	185
	1/4	4.2	0.22	1.0	4.2	0.23	1.0	145	181
VP542	1/4	7.9	0.21	1.8	7.2	0.27	1.8	249	285
	3/8	8.9	0.16	2.2	8.9	0.20	2.1	241	277
VP742	3/8	11.9	0.21	2.7	11.8	0.20	2.7	484	520
	1/2	15.1	0.21	3.6	15.3	0.22	3.7	467	503

Note) Values without bracket

Application Example

(1) Blow-off valve

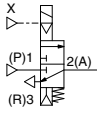

External pilot

(2) Pressure release valve

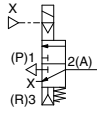

External pilot

(3) Selector valve

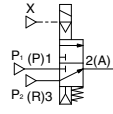

External pilot

(4) Valve for vacuum

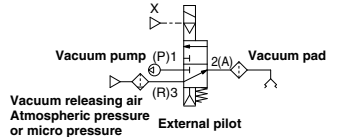

(5) Divider valve

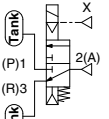

External pilot

(6) Single-acting cylinder drive

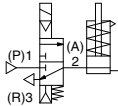

(7) Double-acting cylinder drive

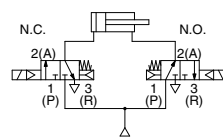

(8) Double-acting cylinder drive (Exhaust center)

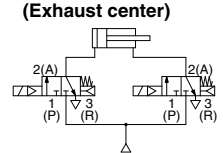

Construction

Body ported

Symbol

Pilot type	N.C.	N.O.
Internal pilot		
External pilot		

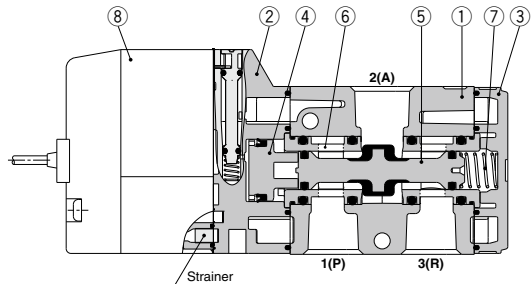

Component Parts

No.	Description	Material	Note
1	Body	Aluminum die-casted	White
2	Adapter plate	Resin	Gray
3	End plate	Resin	White
4	Piston	Resin	
5	Poppet valve	Aluminum/HNBR	
6	Retainer	Resin	
7	Spring	Stainless steel	

Bracket Assembly Part No.

Description	Model	Part no.
Bracket (With 2 screws)	VP342	VP300-227-1A
	VP542	VP500-227-1A
	VP742	VP700-227-1A

Replacement Parts

No.	Description	Part no.	Note
8	Pilot valve assembly	Refer to "How to Order Pilot Valve Assembly" on page 1267.	Built-in strainer

How to Order Pilot Valve Assembly

⚠ Caution

When only the pilot valve assembly is replaced, it is not possible to change from V211 (Grommet or L/M-type) to V212 (DIN or Conduit type), or vice versa.

Valve model: **VP**□□□□□□ - **5** **G** **Z** □ **1** - □□□□

* Select from the below in accordance with the valve used.

■ Grommet or L/M-type

V 2 1 1 □□□□ - **5** **G** **Z**

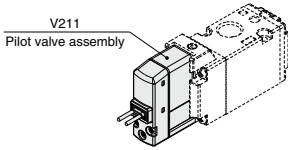

● Light/surge voltage suppressor

		DC	AC
Nil	Without light/surge voltage suppressor	○	○
S	With surge voltage suppressor	○	— ^(Note)
Z	With light/surge voltage suppressor	○	○
R	With surge voltage suppressor (Non-polar)	○	—
U	With light/surge voltage suppressor (Non-polar)	○	—

(Note) There is no S option for AC mode, since a rectifier prevents surge voltage generation. When T is selected, only Z type of light/surge voltage suppressor is available.

⚠ Caution

When using the surge voltage suppressor type, residual voltage will remain. Refer to page 1300 for details.

● Electrical entry

G	Grommet (Lead wire length 300 mm)	
H	Grommet (Lead wire length 600 mm)	
L	L-type plug connector	With lead wire
LN	L-type plug connector	Without lead wire
LO	L-type plug connector	Without connector
M	M-type plug connector	With lead wire
MN	M-type plug connector	Without lead wire
MO	M-type plug connector	Without connector

* LN and MN types are with 2 sockets.

* Refer to page 1294 when different length of lead wire for L/M-type plug connector is required.

■ DIN or Conduit type

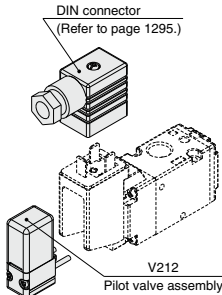

V 2 1 2 □□□□ - **5**

● Pressure specification

Nil	Standard (0.7 MPa)
K	High-pressure type (1.0 MPa)

● Coil specification

Nil	Standard
T	With power saving circuit (DC only)

* T type is only available for DC mode.

● Rated voltage

DC	
5	24 VDC
6	12 VDC

AC (50/60 Hz)

1	100 VAC
2	200 VAC
3	110 VAC [115 VAC]
4	220 VAC [230 VAC]
7	240 VAC
B	24 VAC

⚠ Caution

For V212 (DIN or Conduit type), the coil specification and voltage (including light/surge voltage suppressor) cannot be changed by changing the pilot valve assembly.

⚠ Caution

Tightening torque of the pilot valve assembly mounting screw
M2.5: 0.32 N·m

VP300/500/700 Series

VP300 Series/Body Ported/Dimensions

Grommet (G)

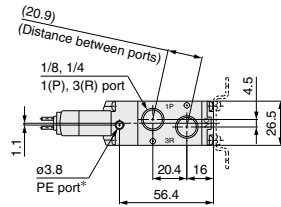
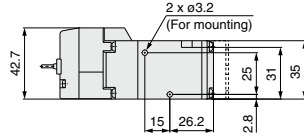
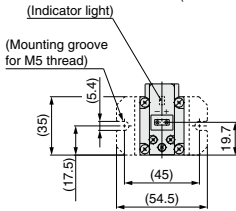
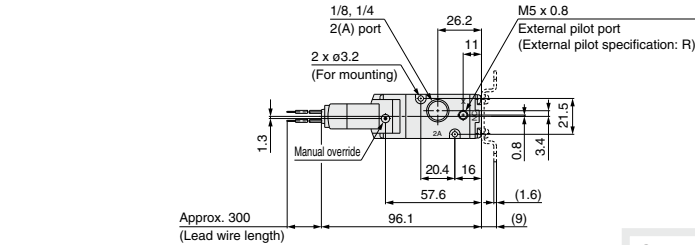

* Refer to page 1291 separately when piping to PE port is required.

Grommet (G) DC without light/surge voltage suppressor

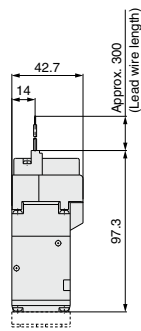

L-type plug connector (L)

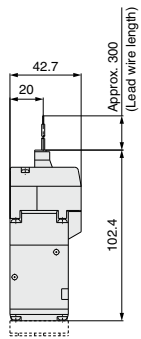

M-type plug connector (M)

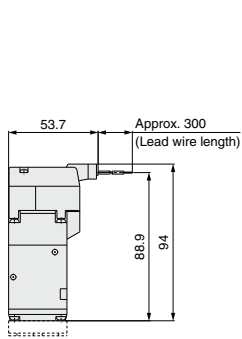

DIN terminal (D, Y)

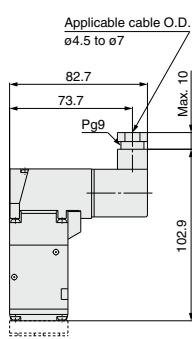

Conduit terminal (T)

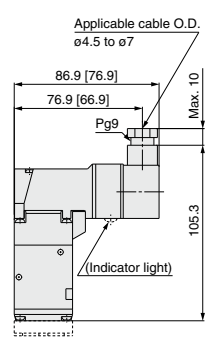

[] : Without indicator light

Pilot Poppet Type Body Ported/Single Unit **VP300/500/700 Series**

VP500 Series/Body Ported/Dimensions

Grommet (G)

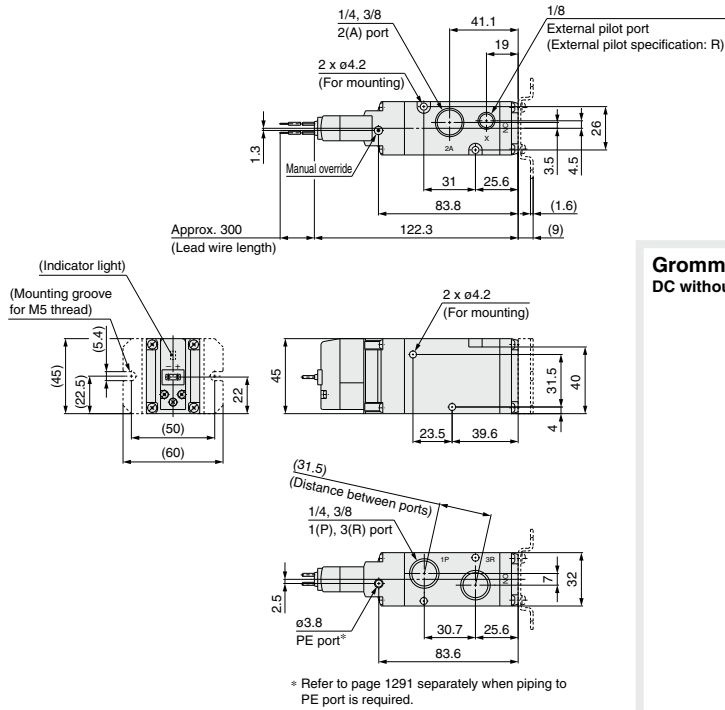

Grommet (G) DC without light/surge voltage suppressor

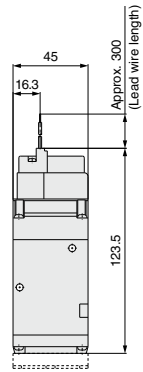

L-type plug connector (L)

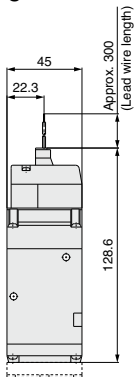

M-type plug connector (M)

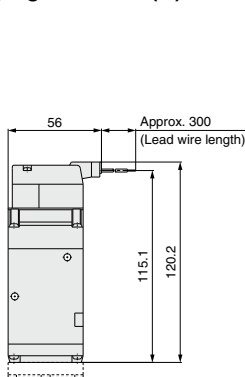

DIN terminal (D, Y)

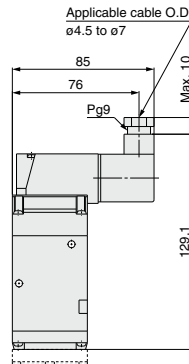

Conduit terminal (T)

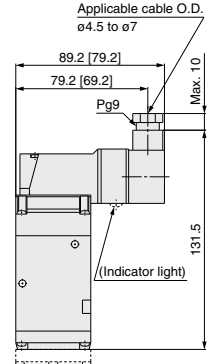

[]: Without indicator light

SYJ

VQZ

VP

VG

VP3

Unless otherwise indicated, dimensions are the same as Grommet (G).

VP300/500/700 Series

VP700 Series/Body Ported/Dimensions

Grommet (G)

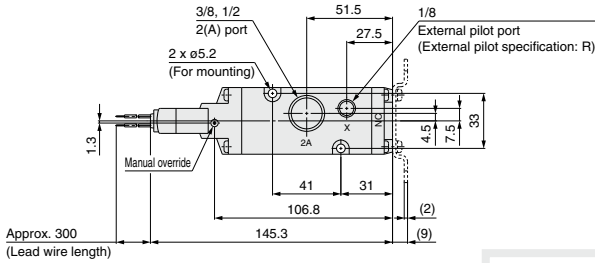

Grommet (G) DC without light/surge voltage suppressor

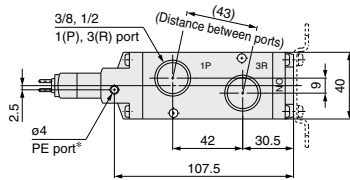
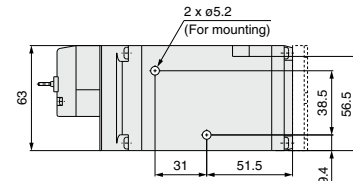
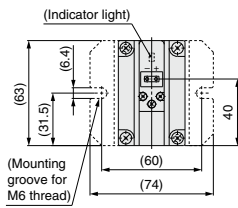

* Refer to page 1291 separately when piping to PE port is required.

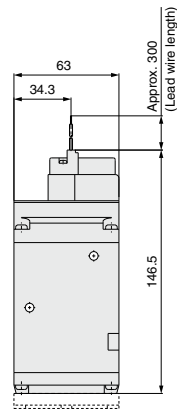

L-type plug connector (L)

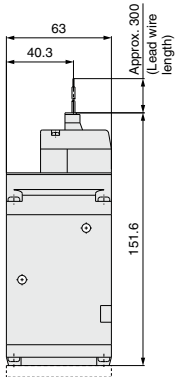

M-type plug connector (M)

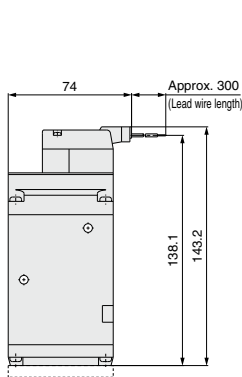

DIN terminal (D, Y)

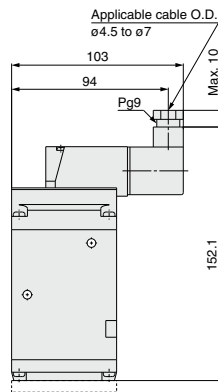

Conduit terminal (T)

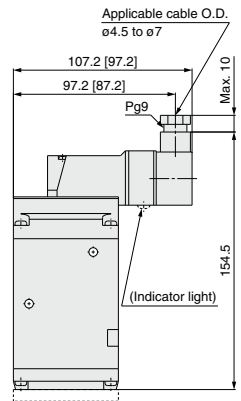

[] : Without indicator light

Unless otherwise indicated, dimensions are the same as Grommet (G).

Rubber Seal 3 Port/Pilot Poppet Type Base Mounted/Single Unit VP300/500/700 Series

How to Order



Note) Only DIN and conduit terminal types are available for AC mode. Refer to the electrical entry for details.



Note) Pressure specifications: 0.7 MPa, DC or 24 VAC only. Only applies to X500 and X505 for made-to-order specifications.

Base mounted

VP 3 4 4 - 5 G 1 - A -

Series

3	VP300
5	VP500
7	VP700

Pilot type

Nil	Internal pilot	●
R	External pilot	●

UL-compliant

Pressure specification

Nil	Standard (0.7 MPa)	●
K	High-pressure type (1.0 MPa)	—

UL-compliant

Coil specification

Nil	Standard
T	With power saving circuit (DC only)

Note) Be sure to select the power saving circuit type when it is continuously energized for a long time. (Refer to page 1296 for details.)

* T type is only available for DC mode. When T is selected, only Z type of light/surge voltage suppressor is available.

(Note that when the electrical entry of DIN terminal type without connector is selected, only DOS and YOS are available.)

Rated voltage

DC		UL-compliant
5	24 VDC	●
6	12 VDC	●

AC (50/60 Hz) Note)

AC (50/60 Hz) Note)		UL-compliant
1	100 VAC	—
2	200 VAC	—
3	110 VAC (115 VAC)	—
4	220 VAC (230 VAC)	—
7	240 VAC	—
B	24 VAC	●

Note) For triac output, refer to the made-to-order specifications (X600).

Type of actuation

A	N.C. (Normally closed)
B	N.O. (Normally open)

Thread type

Nil	Rc
F	G
N	NPT
T	NPTF

Made to Order

Nil	—	●
X500	Pilot exhaust port with piping thread (M3) specification (Refer to page 1291).	●
X600	Triac output specification (Refer to page 1291).	—

Port size (Sub-plate)

Symbol	Port size	VP300	VP500	VP700
Nil	Without sub-plate*	—	—	—
01	1/8	○	—	—
02	1/4	○	○	—
03	3/8	—	○	○
04	1/2	—	—	○

* With a gasket and two mounting bolts.

Electrical entry

Grommet	L-type plug connector	M-type plug connector	DIN terminal (IP65 compatible)	DIN (EN175301-803) terminal (IP65 compatible)	Conduit terminal (IP65 compatible)
G: Lead wire length 300 mm H: Lead wire length 600 mm	L: With lead wire (length 300 mm)	M: With lead wire (length 300 mm)	D: With connector	Y: With connector	T: Conduit terminal
G: Lead wire length 300 mm H: Lead wire length 600 mm DC Without light/surge voltage suppressor	LN: Without lead wire	MN: Without lead wire	DO: Without connector	YO: Without connector	
LO: Without connector	MO: Without connector				

Manual override

Nil: Non-locking push type	D: Push-turn locking slotted type	E: Push-turn locking lever type

Light/surge voltage suppressor

	DC	AC
Nil	Without light/surge voltage suppressor	○ ○
S	With surge voltage suppressor	○ ○ (Non-)
Z	With light/surge voltage suppressor	○ ○
R	With surge voltage suppressor (Non-polar)	○ —
U	With light/surge voltage suppressor (Non-polar)	○ —

Note) There is no S option for AC mode, since a rectifier prevents surge voltage generation.

* In the DIN terminal type, since a light is installed in the connector, DOZ, DOU, YOZ, YOU are not available.

⚠ Caution

When using the surge voltage suppressor type, residual voltage will remain. Refer to page 1300 for details.

* LN and MN types are with 2 sockets.
* Refer to page 1294 when different length of lead wire for L/M-type plug connector is required.
* Refer to page 1295 for details on the DIN (EN175301-803) terminal.
Note) With the same specifications as the DC type, all lead wire entries for the 24 VAC type are CE marking compliant.

VP300/500/700 Series

Low power consumption 1.5 W (DC)

Possible to use as either a selector or divider valve

Possible to change from N.C. to N.O.

- Refer to page 1300 for changing the type of actuation.

Possible to use in vacuum applications

Up to -100 kPa



VP300 Series



VP500 Series



VP700 Series

External Pilot

Use external pilot type in the following cases:

- For vacuum or for low pressure 0.2 MPa or less
- Please consult with SMC for use in a vacuum hold application.
- When having P port downsized in diameter
- When using A port as the atmospheric releasing port, e.g. air blower
- If manifold, external pilot piping can be centralized in manifold base.



Made to Order
(Refer to page 1291 for details.)

X500	Pilot exhaust port with piping thread (M3) specification
X600	Triac output specification

Specifications

Fluid		Air
Type of actuation		N.C. or N.O. (Convertible)
Internal pilot Operating pressure range (MPa)	Standard	0.2 to 0.7
	High-pressure type	0.2 to 1.0
External pilot Operating pressure range (MPa)	Standard	-100 kPa to 0.7
	High-pressure type	-100 kPa to 1.0
	Pilot pressure range	Same as operating pressure (Min. 0.2 MPa)
Ambient and fluid temperature (°C)		-10 to 50 (No freezing)
Max. operating frequency (Hz)		5
Manual override		Non-locking push type Push-turn locking slotted type Push-turn locking lever type
Pilot exhaust type		Individual exhaust
Lubrication		Not required
Mounting orientation		Unrestricted
Impact/Vibration resistance (m/s ²) ^{Note}		300/50
Enclosure		Dust-tight (IP65 for D, Y, T)

Note) Impact resistance: No malfunction occurred when it is tested in the axial direction and at the right angles to the main valve and armature in both energized and de-energized states every once for each condition. (Values at the initial period)

Vibration resistance: No malfunction occurred in a one-sweep test between 45 and 2000 Hz. Test was performed at both energized and de-energized states in the axial direction and at the right angles to the main valve and armature. (Values at the initial period)

Solenoid Specifications

Electrical entry		Grommet (G), (H)	DIN terminal (D)
		L-type plug connector (L) M-type plug connector (M)	DIN (EN175301-803) terminal (Y) Conduit terminal (T)
Coil rated voltage (V)		DC	24, 12
AC (50/60 Hz)			24, 100, 110, 220, 240
Allowable voltage fluctuation		±10% of rated voltage*	
Power consumption (W)	DC	Standard	1.5 (With light: 1.55)
		With power saving circuit	0.55 ^{Note} (With light only) [Starting 1.55, Holding 0.55]
Apparent power (VA) [*]	AC	24 V	1.5 (With light: 1.55)
		100 V	1.5 (With light: 1.75)
		110 V [115 V]	0.75 ^{Note} (With light only) [Starting 1.75, Holding 0.75]
		200 V	1.55 (With light: 1.65)
		220 V [230 V]	1.55 (With light: 1.7)
		240 V	1.55 (With light: 1.7)
Surge voltage suppressor		Diode (Non-polar type: Varistor)	
Indicator light		LED (Neon bulb is used for AC mode of D, Y, T.)	

* It is in common between 110 VAC and 115 VAC, and between 220 VAC and 230 VAC.

* Allowable voltage fluctuation is -15% to +5% of the rated voltage for 115 VAC or 230 VAC.

* Since voltage drops due to the internal circuit in S, Z, T types (with power saving circuit), the allowable voltage fluctuation should be within the following range.

24 VDC: -7% to +10%

12 VDC: -4% to +10%

Note) Refer to page 1296 for details.

Response Time

Model	Pressure specifications	Response time ms (at 0.5 MPa)			
		Without light/surge voltage suppressor	With light/surge voltage suppressor		AC
		S, Z type	R, U type		
VP344	Standard (0.2 to 0.7)	13 or less	38 or less	16 or less	38 or less
	High-pressure type (0.2 to 1.0)	17 or less	42 or less	20 or less	42 or less
VP544	Standard (0.2 to 0.7)	14 or less	39 or less	17 or less	39 or less
	High-pressure type (0.2 to 1.0)	18 or less	43 or less	21 or less	43 or less
VP744	Standard (0.2 to 0.7)	19 or less	44 or less	22 or less	44 or less
	High-pressure type (0.2 to 1.0)	22 or less	47 or less	25 or less	47 or less

Note) Based on dynamic performance test, JIS B 8374-1981. (Coil temperature: 20°C, at rated voltage)

Pilot Poppet Type Base Mounted/Single Unit **VP300/500/700 Series**

Flow Rate Characteristics/Weight

Model	Port size	1 ↔ 2 (P ↔ A)			2 ↔ 3 (A ↔ R)			Weight (g) ^{Note)}	
		C [dm ³ /(s·bar)]	b	Cv	C [dm ³ /(s·bar)]	b	Cv	Grommet	DIN terminal
VP344	1/8	3.6	0.22	0.8	3.5	0.24	0.8	216 (149)	252 (185)
	1/4	3.9	0.22	0.9	3.8	0.14	0.9	211 (149)	247 (185)
VP544	1/4	7.5	0.16	1.7	7.3	0.20	1.7	370 (245)	406 (281)
	3/8	8.8	0.07	2.0	8.8	0.13	2.0	362 (245)	398 (281)
VP744	3/8	12.9	0.10	2.9	13.3	0.24	3.1	676 (459)	712 (495)
	1/2	14.7	0.05	3.3	15.0	0.17	3.4	658 (459)	694 (495)

Note) (): Values without sub-plate

Application Example

(1) Blow-off valve

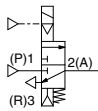

External pilot

(2) Pressure release valve

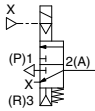

External pilot

(3) Selector valve

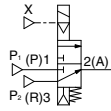

External pilot

(4) Valve for vacuum

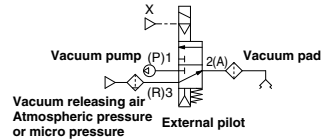

(5) Divider valve

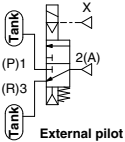

External pilot

(6) Single-acting cylinder drive

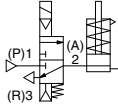

(7) Double-acting cylinder drive

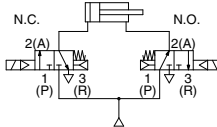

(8) Double-acting cylinder drive (Exhaust center)

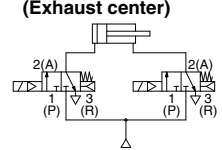

Construction

Base mounted

Symbol

Pilot type	N.C.	N.O.
Internal pilot		
External pilot		

Component Parts

No.	Description	Material	Note
1	Body	Aluminum die-casted	White
2	Adapter plate	Resin	Gray
3	End plate	Resin	White
4	Piston	Resin	
5	Poppet valve	Aluminum/HNBR	
6	Retainer	Resin	
7	Spring	Stainless steel	

Replacement Parts

No.	Description	Part no.			Note
		VP344	VP544	VP744	
8	Pilot valve assembly	Refer to "How to Order Pilot Valve Assembly" on page 1274.			Built-in strainer
9	Gasket	VP300-217-1	VP500-217-1	VP700-217-1	HNBR
10	Sub-plate	VP300-202-□	VP500-202-□	VP700-202-□	Aluminum die-casted
—	Hexagon socket head bolt (1 pc.)	VP300-224-1 (M3 x 36)	VP500-224-1 (M4 x 46)	VP700-224-1 (M5 x 66)	For valve mounting

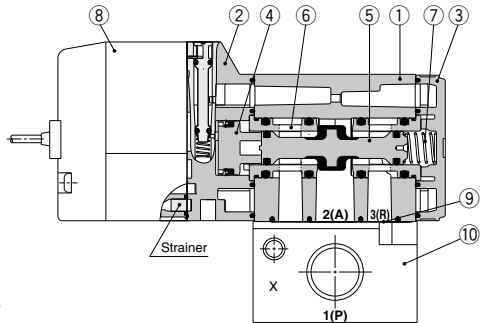

SYJ

VQZ

VP

VG

VP3

How to Order Sub-plate

VP 3 00-202-1

Series

3	VP344
5	VP544
7	VP744

Thread type

Nil	Rc
F	G
N	NPT
T	NPTF

Port size

Symbol	VP344	VP544	VP744
1	1/8	1/4	3/8
2	1/4	3/8	1/2

Note) These specifications are common to the internal and external pilots.

⚠ Caution

Tightening Torque of Mounting Screw

M3: 0.8 N·m
M4: 1.4 N·m
M5: 2.9 N·m

VP300/500/700 Series

How to Order Pilot Valve Assembly

⚠ Caution

When only the pilot valve assembly is replaced, it is not possible to change from V211 (Grommet or L/M-type) to V212 (DIN or Conduit type), or vice versa.

Valve model: VP□□□□□□ - 5 G Z □ 1 - □□□□

* Select from the below in accordance with the valve used.

■ Grommet or L/M-type

V 2 1 1 □□ - 5 G Z

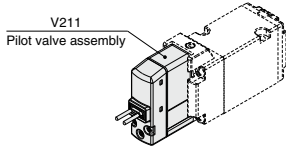

● Light/surge voltage suppressor

		DC	AC
Nil	Without light/surge voltage suppressor	<input type="radio"/>	<input type="radio"/>
S	With surge voltage suppressor	<input type="radio"/>	<input type="radio"/>
Z	With light/surge voltage suppressor	<input type="radio"/>	<input type="radio"/>
R	With surge voltage suppressor (Non-polar)	<input type="radio"/>	<input type="radio"/>
U	With light/surge voltage suppressor (Non-polar)	<input type="radio"/>	<input type="radio"/>

Note) There is no S option for AC mode, since a rectifier prevents surge voltage generation. When T is selected, only Z type of light/surge voltage suppressor is available.

⚠ Caution

When using the surge voltage suppressor type, residual voltage will remain. Refer to page 1300 for details.

● Electrical entry

G	Grommet (Lead wire length 300 mm)	
H	Grommet (Lead wire length 600 mm)	
L	L-type plug connector	With lead wire
LN		Without lead wire
LO	Without connector	
M	M-type plug connector	With lead wire
MN		Without lead wire
MO	Without connector	

* LN and MN types are with 2 sockets.
* Refer to page 1294 when different length of lead wire for L/M-type plug connector is required.

■ DIN or Conduit type

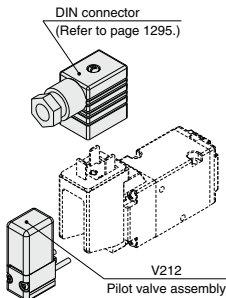

V 2 1 2 □□ - 5

● Pressure specification

Nil	Standard (0.7 MPa)
K	High-pressure type (1.0 MPa)

● Coil specification

Nil	Standard
T	With power saving circuit (DC only)

* T type is only available for DC mode.

● Rated voltage

DC	
5	24 VDC
6	12 VDC

AC (50/60 Hz)

1	100 VAC
2	200 VAC
3	110 VAC [115 VAC]
4	220 VAC [230 VAC]
7	240 VAC
B	24 VAC

⚠ Caution

For V212 (DIN or Conduit type), the coil specification and voltage (including light/surge voltage suppressor) cannot be changed by changing the pilot valve assembly.

⚠ Caution

Tightening torque of the pilot valve assembly mounting screw
M2.5: 0.32 N·m

Pilot Poppet Type Base Mounted/Single Unit **VP300/500/700 Series**

VP300 Series/Base Mounted/Dimensions

Grommet (G)

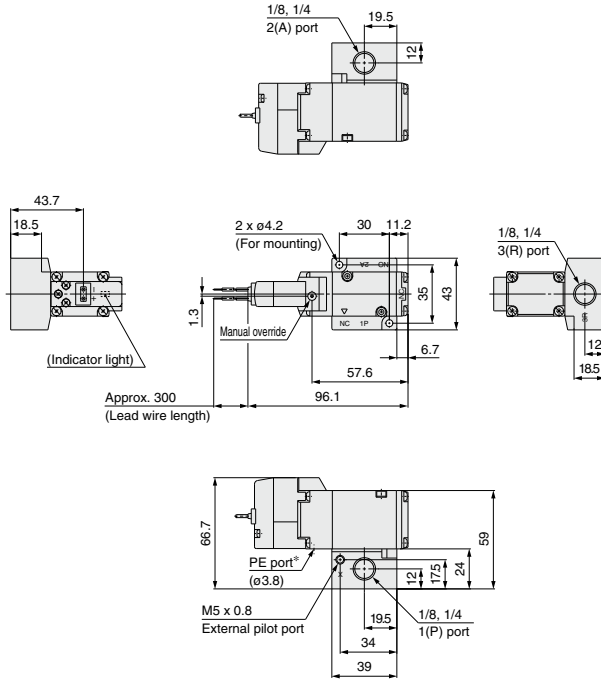

Grommet (G)
DC without light/surge voltage suppressor

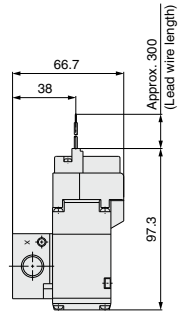

* Refer to page 1291 separately when piping to PE port is required.

L-type plug connector (L)

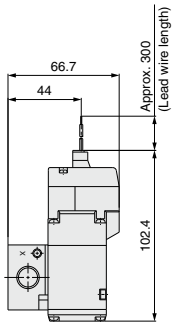

M-type plug connector (M)

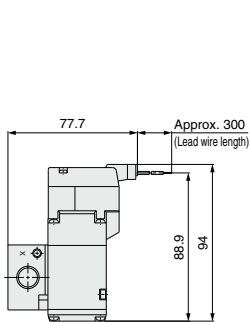

DIN terminal (D, Y)

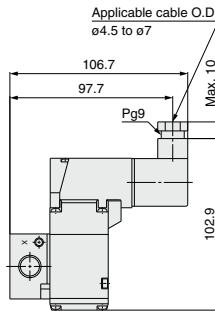

Conduit terminal (T)

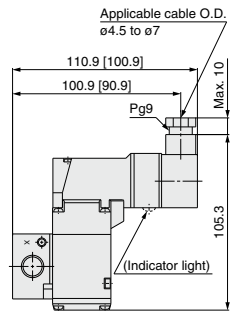

[]: Without indicator light

- SYJ
- VQZ
- VP
- VG
- VP3

Unless otherwise indicated, dimensions are the same as Grommet (G).

VP300/500/700 Series

VP500 Series/Base Mounted/Dimensions

Grommet (G)

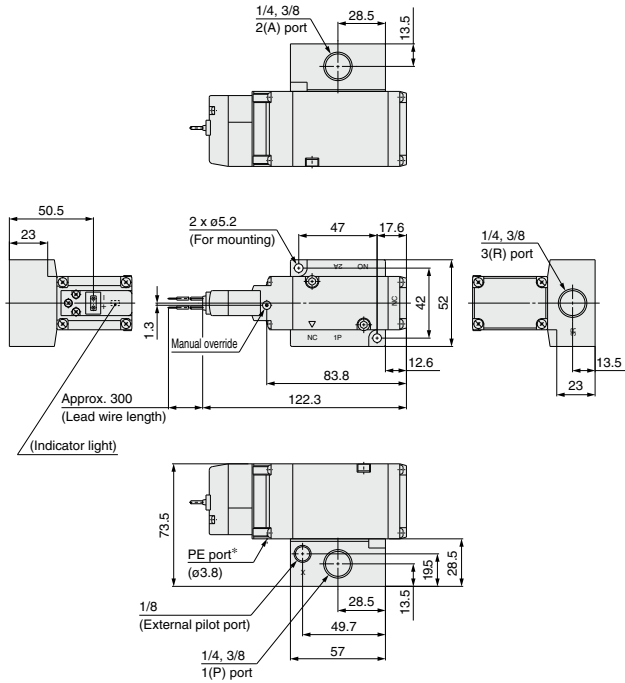

Grommet (G) DC without light/surge voltage suppressor

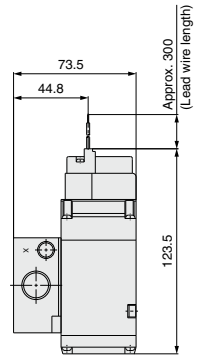

* Refer to page 1291 separately when piping to PE port is required.

L-type plug connector (L)

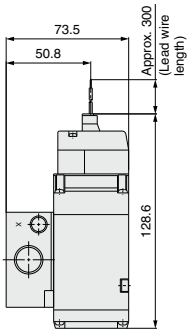

M-type plug connector (M)

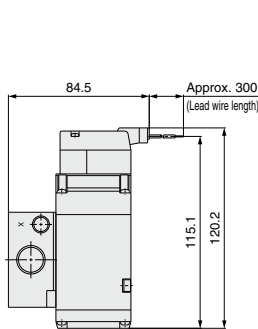

DIN terminal (D, Y)

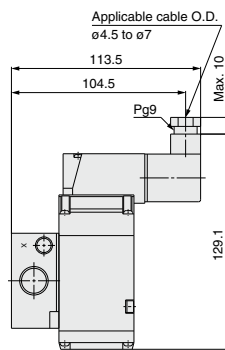

Conduit terminal (T)

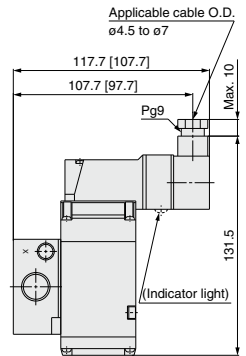

[]: Without indicator light

VP700 Series/Base Mounted/Dimensions

Grommet (G)

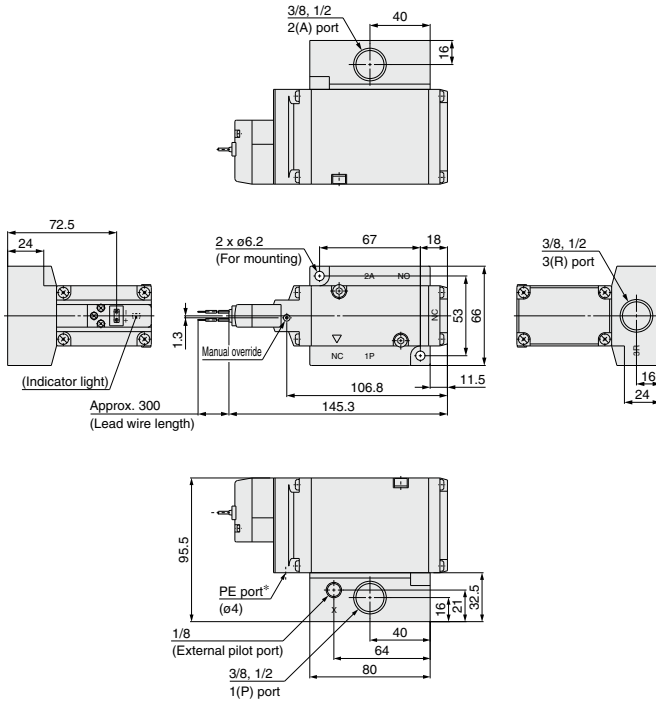

Grommet (G)
DC without light/surge voltage suppressor

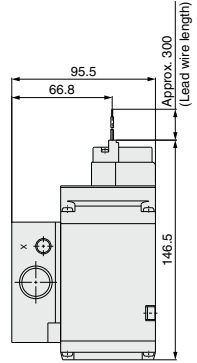

* Refer to page 1291 separately when piping to PE port is required.

L-type plug connector (L)

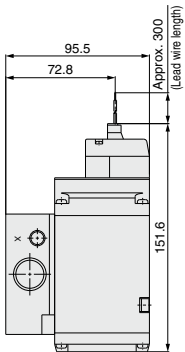

M-type plug connector (M)

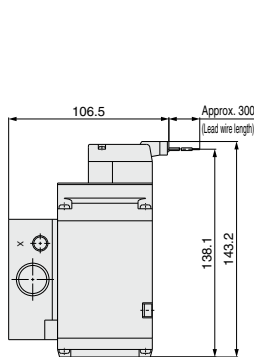

DIN terminal (D, Y)

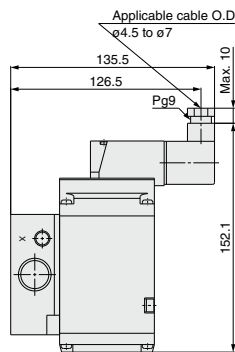

Conduit terminal (T)

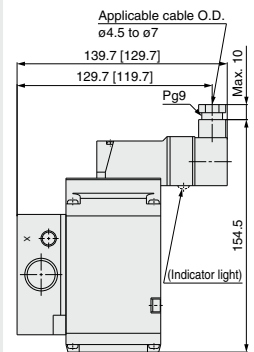

[]: Without indicator light

Unless otherwise indicated, dimensions are the same as Grommet (G).

Body Ported
Base Mounted

Low Wattage Specification VP300/500 Series

RoHS

How to Order Valve



Note) AC-type models that are CE-compliant have DIN terminals only. Refer to the electrical entry for details.

VP 3 4 2 R Y - 5 D Z E 1 - 02 T A - F

Series

3	VP300
5	VP500

Body type

Mountable manifold	
2	Body ported
4	Base mounted

Note) Refer to page 1282.

Pilot type

Nil	Internal pilot
R	External pilot

Low wattage type

Rated voltage

1	100 VAC
2	200 VAC
3	110 VAC
4	220 VAC
5	24 VDC
6	12 VDC

Electrical entry

24 VDC, 12 VDC/100 VAC, 110 VAC, 200 VAC, 220 VAC				24 VDC, 12 VDC/100 VAC, 110 VAC, 200 VAC, 220 VAC	
Grommet		L-type plug connector	M-type plug connector	DIN terminal	
G: Lead wire length 300 mm	L: With lead wire (Length 300 mm)	M: With lead wire (Length 300 mm)	MN: Without lead wire	<IP65 compatible> D: With connector	<IP65 compatible> Y: With connector
H: Lead wire length 600 mm	LN: Without lead wire	LO: Without connector	MO: Without connector	DO: Without connector	YO: Without connector
DC	●	●	●	●	●
AC	—	—	—	●	●

* LN and MN types are with 2 sockets.
* Y type DIN terminal complies with EN-175301-803C (former DIN 43650C). Refer to page 1299 for details.

Light/Surge voltage suppressor

Electrical entry for G, H, L, M		Electrical entry for D, Y	
Nil	Without light/surge voltage suppressor	Nil	Without light/surge voltage suppressor
S	With surge voltage suppressor	S	With surge voltage suppressor (Non-polar type)
Z	With light/surge voltage suppressor	Z	With light/surge voltage suppressor (Non-polar type)
R	With surge voltage suppressor (Non-polar type)		
U	With light/surge voltage suppressor (Non-polar type)		

* For AC voltage valves there is no "S" option. It is already built-in to the rectifier circuit.
* For "R" and "U", DC voltage is only available.
* DOZ and YOZ are not available.
* For AC voltage valves there is no "S" option. It is already built-in to the rectifier circuit.

Bracket

Nil	Without bracket
F	With bracket*

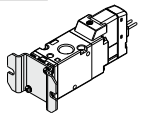

* Body ported only

Type of actuation

A	N.C.(Normally closed)
B	N.O.(Normally open)

Thread type

Nil	Rc, M5
F	G
N	NPT
T	NPTF

Port size

Body Ported

Symbol	Port size	VP300	VP500
01	1/8	○	—
02	1/4	○	○
03	3/8	—	○

Base Mounted

Symbol	Port size	VP300	VP500
Nil	Without sub-plate*	—	—
01	1/8	○	—
02	1/4	○	○
03	3/8	—	○

* With a gasket and two mounting bolts.

Manual override

Nil	Non-locking push type
D	Push-turn locking slotted type
E	Push-turn locking lever type

Specifications

Fluid	Air
Type of actuation	N.C. or N.O. (Convertible)
Internal pilot operating pressure range (MPa)	0.2 to 0.7
External pilot operating pressure range (MPa)	-100 KPa to 0.7
Pilot pressure range	Equivalent to operating pressure (Min. 0.2)
Ambient and fluid temperature (°C)	-10 to 50 (No freezing)
Max. operating frequency (Hz)	5
Manual override	Non-locking push type Push-turn locking slotted type Push-turn locking lever type
Pilot exhaust type	Individual exhaust
Lubrication	Not required
Mounting orientation	Unrestricted
Impact/Vibration resistance (m/s ²) <small>Note)</small>	150/30
Enclosure	Dustproof (IP65 for D and Y)

Note) Impact resistance: No malfunction occurred when it is tested in the axial direction and at the right angles to the main valve and armature in both energized and de-energized states every once for each condition. (Values at the initial period)

Vibration resistance: No malfunction occurred in a one-sweep test between 45 and 2000 Hz. Test was performed at both energized and de-energized states in the axial direction and at the right angles to the main valve and armature. (Values at the initial period)

Solenoid Specifications

Electrical entry		Grommet (G), (H) L-type plug connector (L) M-type plug connector (M) G, H, L, M	DIN terminal (D) DIN (43650B) terminal (Y) D, Y	
Coil rated voltage (V)	DC	24, 12		
	AC (50/60 Hz)	100, 110, 200, 220		
Allowable voltage fluctuation		±10% of rated voltage*		
Power consumption (W)	DC Standard	0.35 (With light: 0.4 (With light of DIN terminal: 0.45))		
Apparent power (VA) [†]	AC	100 V	0.78 (With light: 0.81)	0.78 (With light: 0.87)
		110 V [115 V]	0.86 (With light: 0.89) [0.94 (With light: 0.97)]	0.86 (With light: 0.97) [0.94 (With light: 1.07)]
		200 V	1.18 (With light: 1.22)	1.15 (With light: 1.30)
		220 V [230 V]	1.30 (With light: 1.34) [1.42 (With light: 1.46)]	1.27 (With light: 1.46) [1.39 (With light: 1.60)]
		Surge voltage suppressor	Diode (DIN terminal, Non-polar type: Varistor)	
Indicator light		LED (Neon bulb is used for AC mode of D and Y.)		

* It is in common between 110 VAC and 115 VAC, and between 220 VAC and 230 VAC.

† Allowable voltage fluctuation is -15% to +5% of the rated voltage for 115 VAC or 230 VAC.

‡ For details, refer to page 1298.

SYJ

VQZ

VP

VG

VP3

Response Time

Series	Type of actuation	Response time ms (at 0.5 MPa)			
		Without light/surge voltage suppressor	With light/surge voltage suppressor		AC type
			S, Z type	R, U type	
VP300	VP342Y	16	40	21	40
	VP344Y	16	40	21	40
VP500	VP542Y	31	45	36	44
	VP544Y	31	45	36	44

Note) Based on dynamic performance test, JIS B 8419: 2010.
(Coil temperature: 20°C, at rated voltage)

VP300/500 Series

Dimensions

VP342Y

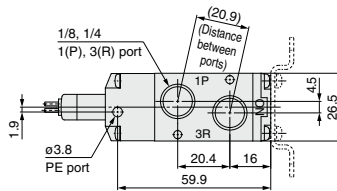
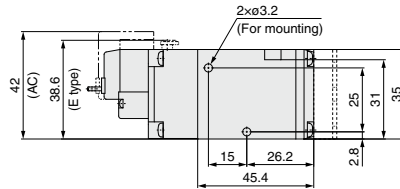
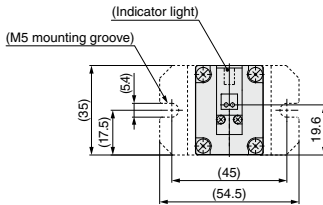
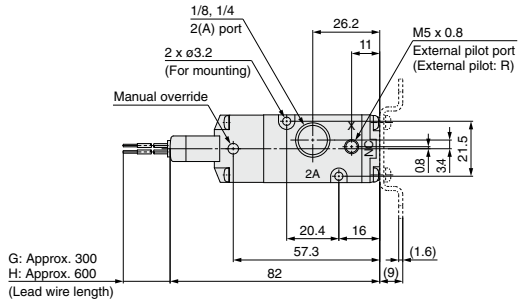

L-type plug connector (L)

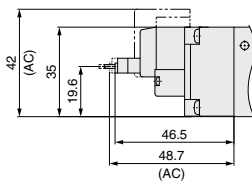

M-type plug connector (M)

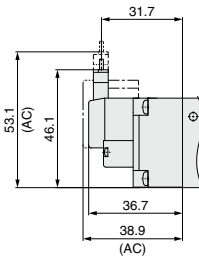

DIN terminal (D,Y)

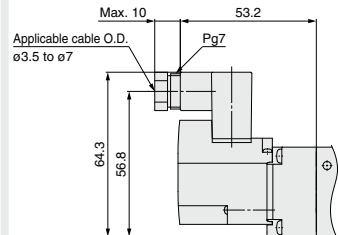

Low Wattage Specification Body Ported/Base Mounted **VP300/500 Series**

Dimensions

VP542Y

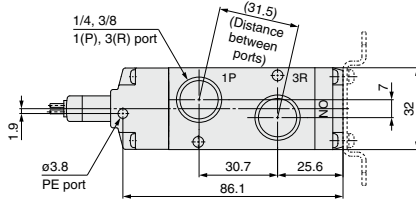
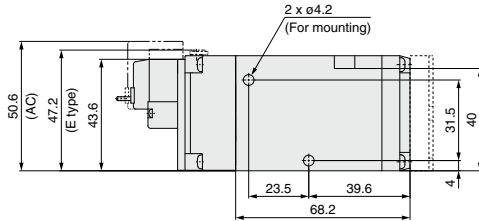
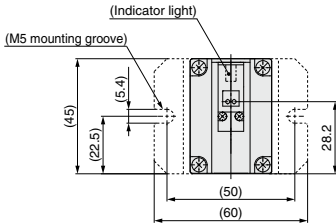
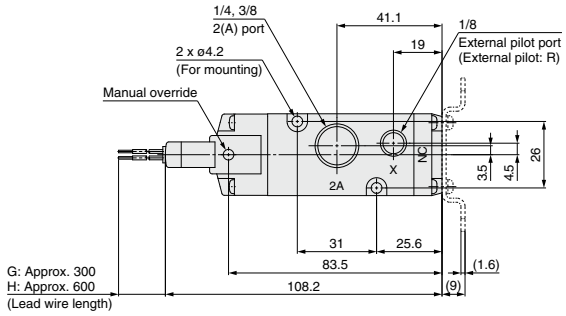

SYJ
VQZ
VP
VG
VP3

L-type plug connector (L)

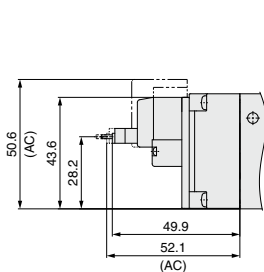

M-type plug connector (M)

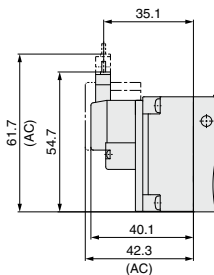

DIN terminal (D,Y)

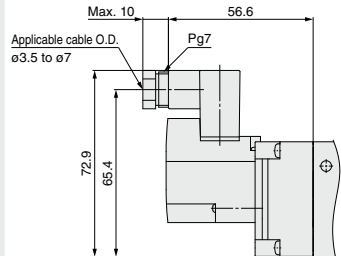

Rubber Seal/3 Port/Pilot Poppet Type Manifold Common Exhaust **Type 41/** Individual Exhaust **Type 42** **VP300/500/700 Series**

How to Order Manifold

Type 41/Common exhaust

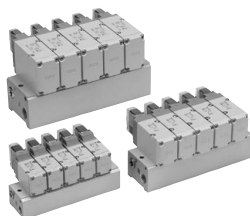

VV3P **3** - 41 - **04** 1 - **02**

Series

3	VP300
5	VP500
7	VP700

Pilot type

Nil	Internal pilot
R	External pilot

Note) When the external pilot type manifold is selected, external pilot type valves are mounted.

Thread type

Nil	Rc
F	G
N	NPT
T	NPTF

Port size

Symbol	Port size	Applicable series
02	1/4	VP300
03	3/8	VP500
04	1/2	VP700

Stations

02	2 stations
:	:
20	20 stations

Type 42/Individual exhaust



VV3P **3** - 42 - **04** 3 - **02**

Series

3	VP300
5	VP500
7	VP700

Pilot type

Nil	Internal pilot
R	External pilot

Note) When the external pilot type manifold is selected, external pilot type valves are mounted.

Thread type

Nil	Rc
F	G
N	NPT
T	NPTF

Port size

Symbol	Port size	Applicable series
02	1/4	VP300
03	3/8	VP500
04	1/2	VP700

Stations

02	2 stations
:	:
20	20 stations

Pilot Poppet Type Common Exhaust **Type 41** / Individual Exhaust **Type 42** **VP300/500/700 Series**



Note) Only DIN and conduit terminal types are available for AC mode. Refer to the electrical entry for details.



Note) Pressure specifications: 0.7 MPa, DC or 24 VAC only. Only applies to X500 and X505 for made-to-order specifications.

How to Order Valve (With a gasket and two mounting bolts)

* For low wattage specification, refer to "How to Order Valve" on page 1278.

VP 3 4 4 **- 5 G** **1 - A**

Series

3	VP300
5	VP500
7	VP700

Pilot type UL-compliant

Nil	Internal pilot	●
R	External pilot	●

Pressure specification UL-compliant

Nil	Standard (0.7 MPa)	●
K	High-pressure type (1.0 MPa)	—

Coil specification

Nil	Standard
T	With power saving circuit (DC only)

Note) Be sure to select the power saving circuit type when it is continuously energized for a long time. (Refer to page 1296 for details.)

* T type is only available for DC mode. When T is selected, only Z type of light/surge voltage suppressor is available.

(Note that when the electrical entry of DIN terminal type without connector is selected, only DOS and YOS are available.)

Rated voltage

DC	UL-compliant	
5	24 VDC	●
6	12 VDC	●

AC (50/60 Hz) Note UL-compliant

1	100 VAC	—
2	200 VAC	—
3	110 VAC (115 VAC)	—
4	220 VAC (230 VAC)	—
7	240 VAC	—
B	24 VAC	●

Note) For triac output, refer to the made-to-order specifications (X600).

Type of actuation

A	N.C. (Normally closed)
B	N.O. (Normally open)

Manual override

Nil: Non-locking push type	D: Push-turn locking slotted type	E: Push-turn locking lever type

Light/surge voltage suppressor

Nil	Without light/surge voltage suppressor	DC	AC
S	With surge voltage suppressor	○	○
Z	With light/surge voltage suppressor	○	○
R	With surge voltage suppressor (Non-polar)	○	—
U	With light/surge voltage suppressor (Non-polar)	○	—

Note) There is no S option for AC mode, since a rectifier prevents surge voltage generation.

* In the DIN terminal type, since a light is installed in the connector, DOZ, DOU, YOZ, YOU are not available.

Caution

When using the surge voltage suppressor type, residual voltage will remain. Refer to page 1300 for details.

Made to Order UL-compliant

Nil	—	●
X500	Pilot exhaust port with piping thread (M3) specification (Refer to page 1291).	●
X600	Triac output specification (Refer to page 1291).	—

Electrical entry

Grommet	L-type plug connector	M-type plug connector	DIN terminal	DIN (EN175301-803) terminal	Conduit terminal
G: Lead wire length 300 mm	L: With lead wire (length 300 mm)	M: With lead wire (length 300 mm)	D: With connector	Y: With connector	T: Conduit terminal
H: Lead wire length 600 mm	LN: Without lead wire	MN: Without lead wire	DO: Without connector	YO: Without connector	
G: Lead wire length 300 mm	LO: Without connector	MO: Without connector			
H: Lead wire length 600 mm					
DC	CE	CE	CE	CE	CE
AC	—	—	CE	CE	CE

* LN and MN types are with 2 sockets.

* Refer to page 1294 when different length of lead wire for L/M-type plug connector is required.

* Refer to page 1295 for details on the DIN (EN175301-803) terminal.

Note) With the same specifications as the DC type, all lead wire entries for the 24 VAC type are CE marking compliant.



VP300/500/700 Series

Piping is concentrated on the base side.

All external pilots are gathered in the base.

Common external pilot port allows one piping.

2 types of exhaust ports

Common or individual exhaust type are available. For individual exhaust type, exhaust can be restricted.

Easy to change between N.C. and N.O.

Type of actuation can be easily changed from normally closed to normally open by changing the direction of a valve and end-plate only 180°.

- Refer to page 1300 for changing the type of actuation.



Manifold Specifications

Series	Base model	Piping specifications			Applicable valve	Applicable stations ^(Note)	Manifold base Weight: W [g] Stations: n
		1P (SUP) port type	3R (EXH) port type	Port size			
VP300	VV3P3-41	Common	Common	1/4	VP344	2 to 20 stations	W = 110n + 90
	VV3P3-42		Individual				
VP500	VV3P5-41		Common	3/8	VP544	2 to 20 stations	W = 190n + 150
	VV3P5-42		Individual				
VP700	VV3P7-41		Common	1/2	VP744	2 to 20 stations	W = 410n + 380
	VV3P7-42		Individual				

Note) Supply pressure to 1(P) ports and exhaust pressure from 3(R) ports on both sides for 10 stations or more.

Manifold Option

Description	Part no.	Applicable manifold base model
Blanking plate assembly (With a gasket and two mounting bolts)	VP300-25-1A	VV3P3
	VP500-25-1A	VV3P5
	VP700-25-1A	VV3P7

How to Order Manifold Assembly (Example)

Ordering example (VV3P3-41)

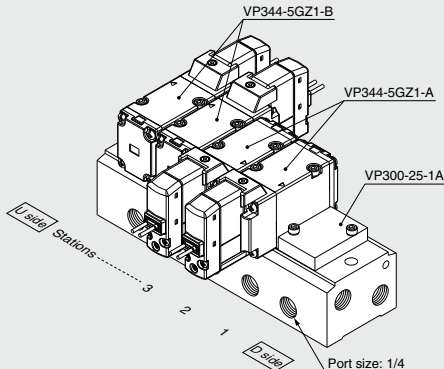

- VV3P3-41-051-02 1 set (Type 41, 5-station manifold base part no.)
 * VP300-25-1A 1 set (Blanking plate assembly part no.)
 * VP344-5GZ1-A 2 sets (N.C. type part no.)
 * VP344-5GZ1-B 2 sets (N.O. type part no.)

The asterisk denotes the symbol for assembly.
Prefix it to the part nos. of the solenoid valve, etc.

* Indicate the valves to be attached below the manifold part number, in order starting from station 1 as shown in the drawing.

VP300 Series/Dimensions

Type 41/Common exhaust: VV3P3-41 □ - [Stations] 1-02
Grommet (G)

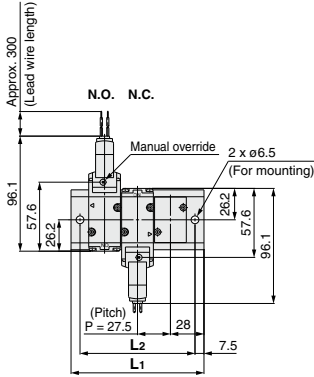

(Station n) ----- (Station 1)

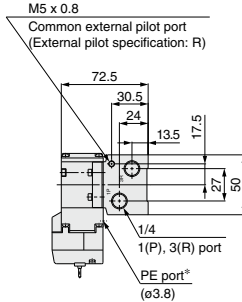

* Refer to page 1291 separately when piping to PE port is required.

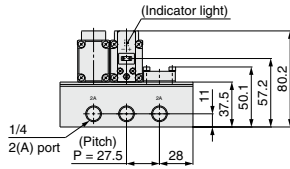

Station n	2 stations	3	4	5	6	7	8	9	10	11	12	13	14	15	16	17	18	19	20 stations
L1	83.5	111	138.5	166	193.5	221	248.5	276	303.5	331	358.5	386	413.5	441	468.5	496	523.5	551	578.5
L2	68.5	96	123.5	151	178.5	206	233.5	261	288.5	316	343.5	371	398.5	426	453.5	481	508.5	536	563.5

Grommet (G)
DC without light/surge voltage suppressor

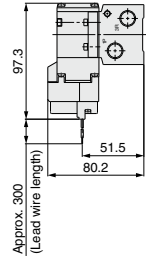

L-type plug connector (L)

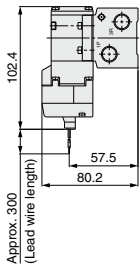

M-type plug connector (M)

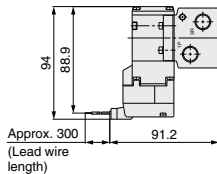

DIN terminal (D, Y)

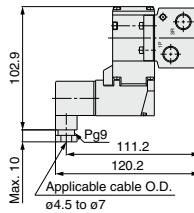

Conduit terminal (T)

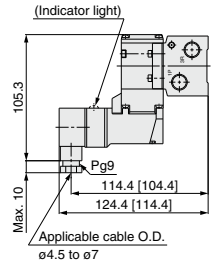

[]: Without indicator light

Unless otherwise indicated, dimensions are the same as Grommet (G).

VP300/500/700 Series

VP300 Series/Dimensions

Type 42/Individual exhaust: VV3P3-42□-□ Stations 3-02

Grommet (G)

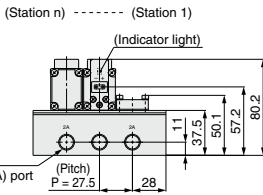
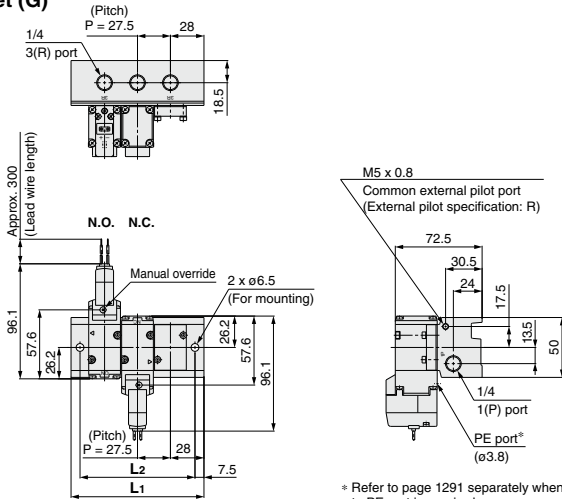

* Refer to page 1291 separately when piping to PE port is required.

Grommet (G) DC without light/surge voltage suppressor

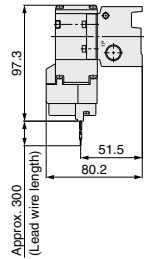

Station n	2 stations	3	4	5	6	7	8	9	10	11	12	13	14	15	16	17	18	19	20 stations
L1	83.5	111	138.5	166	193.5	221	248.5	276	303.5	331	358.5	386	413.5	441	468.5	496	523.5	551	578.5
L2	68.5	96	123.5	151	178.5	206	233.5	261	288.5	316	343.5	371	398.5	426	453.5	481	508.5	536	563.5

L-type plug connector (L)

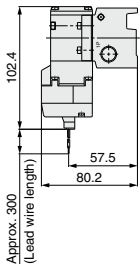

M-type plug connector (M)

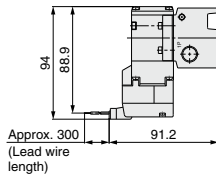

DIN terminal (D, Y)

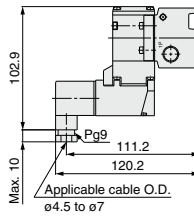

Conduit terminal (T)

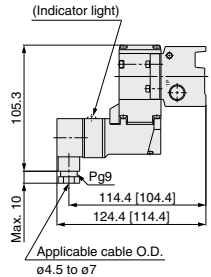

[]: Without indicator light

Unless otherwise indicated, dimensions are the same as Grommet (G).

VP500 Series/Dimensions

Type 41/Common exhaust: VV3P5-41 □ -Stations 1-03
Grommet (G)

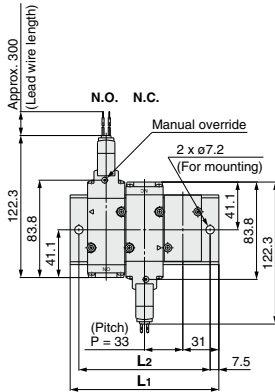

(Station n) ----- (Station 1)

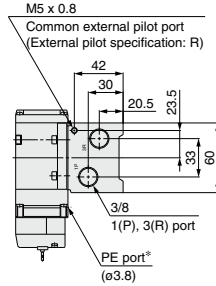
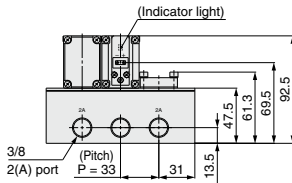

* Refer to page 1291 separately when piping to PE port is required.

Station n	2 stations	3	4	5	6	7	8	9	10	11	12	13	14	15	16	17	18	19	20 stations
L1	95	128	161	194	227	260	293	326	359	392	425	458	491	524	557	590	623	656	689
L2	80	113	146	179	212	245	278	311	344	377	410	443	476	509	542	575	608	641	674

Grommet (G)
DC without light/surge voltage suppressor

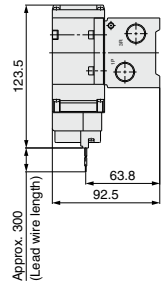

L-type plug connector (L)

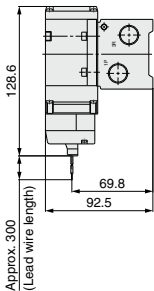

M-type plug connector (M)

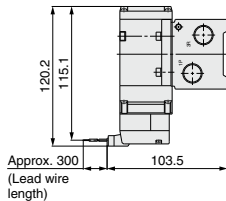

DIN terminal (D, Y)

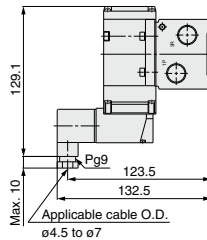

Conduit terminal (T)

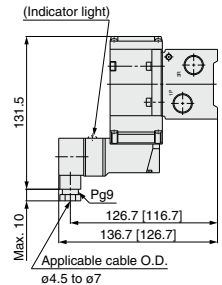

[]: Without indicator light

SYJ

VQZ

VP

VG

VP3

VP300/500/700 Series

VP500 Series/Dimensions

Type 42/Individual exhaust: VV3P5-42□- Stations 3-03

Grommet (G)

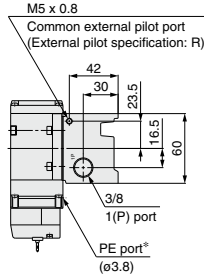
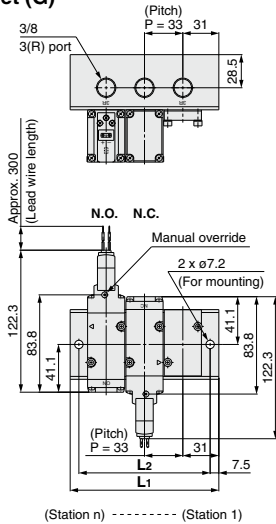

* Refer to page 1291 separately when piping to PE port is required.

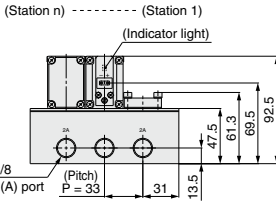

Grommet (G) DC without light/surge voltage suppressor

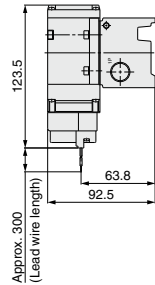

Station n	2 stations	3	4	5	6	7	8	9	10	11	12	13	14	15	16	17	18	19	20 stations
L1	95	128	161	194	227	260	293	326	359	392	425	458	491	524	557	590	623	656	689
L2	80	113	146	179	212	245	278	311	344	377	410	443	476	509	542	575	608	641	674

L-type plug connector (L)

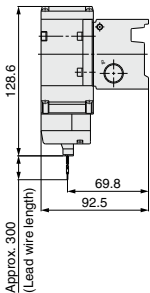

M-type plug connector (M)

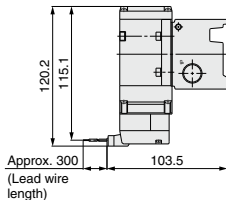

DIN terminal (D, Y)

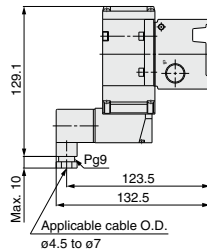

Conduit terminal (T)

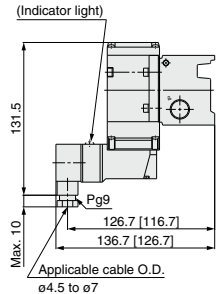

[]: Without indicator light

VP700 Series/Dimensions

Type 41/Common exhaust: **VV3P7-41** □ - Stations **1-04**

Grommet (G)

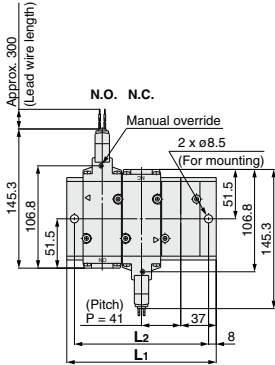

(Station n) ----- (Station 1)

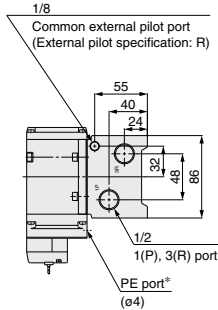

* Refer to page 1291 separately when piping to PE port is required.

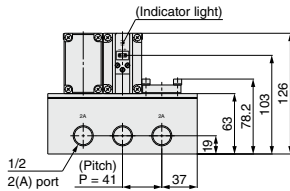

Station n	2 stations	3	4	5	6	7	8	9	10	11	12	13	14	15	16	17	18	19	20 stations
L1	115	156	197	238	279	320	361	402	443	484	525	566	607	648	689	730	771	812	853
L2	99	140	181	222	263	304	345	386	427	468	509	550	591	632	673	714	755	796	837

Grommet (G)
DC without light/surge voltage suppressor

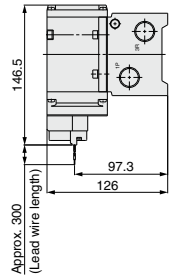

L-type plug connector (L)

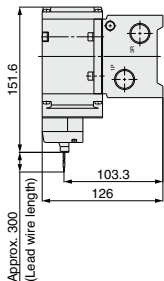

M-type plug connector (M)

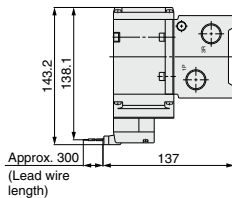

DIN terminal (D, Y)

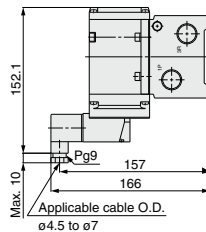

Conduit terminal (T)

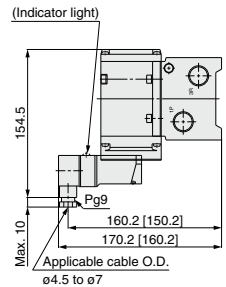

[]: Without indicator light

Unless otherwise indicated, dimensions are the same as Grommet (G).

VP300/500/700 Series

VP700 Series/Dimensions

Type 42/Individual exhaust: VV3P7-42□ - Stations 3-04

Grommet (G)

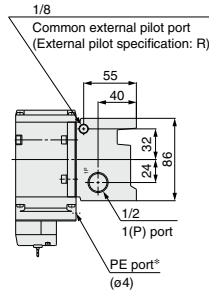
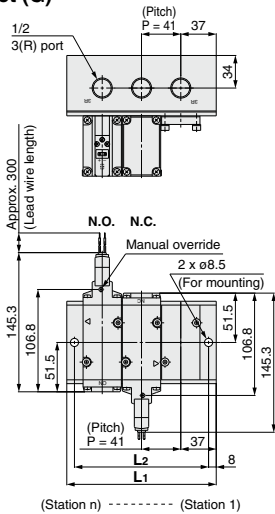

* Refer to page 1291 separately when piping to PE port is required.

(Station n) ----- (Station 1)

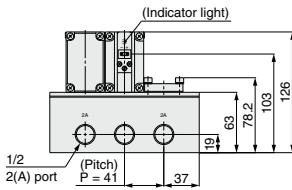

Station n	2 stations	3	4	5	6	7	8	9	10	11	12	13	14	15	16	17	18	19	20 stations
L1	115	156	197	238	279	320	361	402	443	484	525	566	607	648	689	730	771	812	853
L2	99	140	181	222	263	304	345	386	427	468	509	550	591	632	673	714	755	796	837

Grommet (G) DC without light/surge voltage suppressor

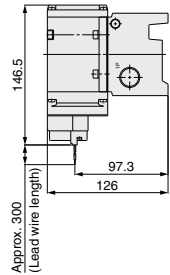

L-type plug connector (L)

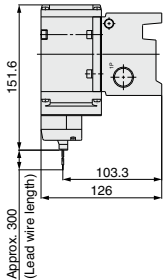

M-type plug connector (M)

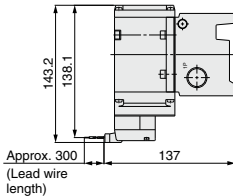

DIN terminal (D, Y)

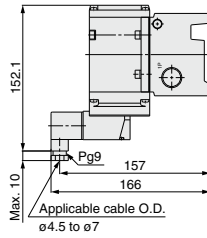

Conduit terminal (T)

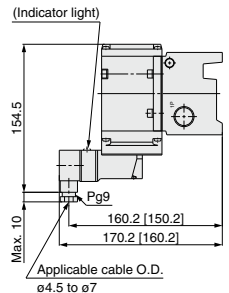

[]: Without indicator light

Unless otherwise indicated, dimensions are the same as Grommet (G).



1 Pilot Exhaust Port with Piping Thread (M3) Specification

In this specification, piping to the pilot exhaust port (PE port) is available when the valve is used in an environment where the exhaust from the pilot valve is not allowable, or intrusion of ambient dust should be prevented.

How to Order Valve

VP $\frac{3}{5}$ $\frac{4}{4}$ □□□ - □□□□□ 1 - □□□□ - X500

- Entry is the same as standard products. The specifications, performance and external dimensions are the same as those of standard models.

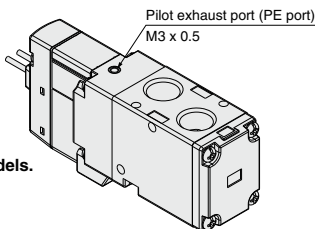

2 Body Ported Interchangeable Specification with the Previous Valve Mounting Hole Pitch Type

The mounting hole has been changed to the long type in order to provide interchangeability with the previous VP300/500 series.

How to Order Valve

VP $\frac{3}{5}$ 42 □□□ - □□□□□ 1 - □□□□ - X505

- Entry is the same as standard products. The specifications, performance and external dimensions are the same as those of standard models.

Note) VP742 is not available because the mounting hole pitch is the same as the previous type.

VP342

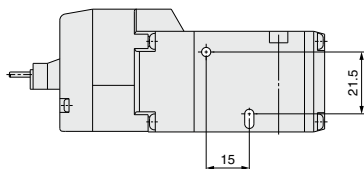

VP542

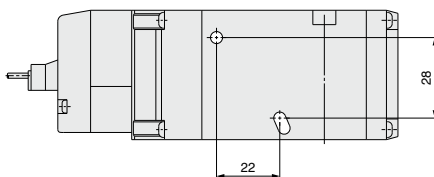

3 TRIAC Output Specification

For AC type valve, use this specification when the pilot valve is not recovered even though valve power supply is turned OFF at the equipment using output unit with large leakage voltage over 8% of the rated voltage (TRIAC output such as PLC or SSR, etc.). Combination with low wattage specification is not possible.

How to Order Valve

VP $\frac{3}{5}$ $\frac{4}{7}$ □□□ - □□□□□ 1 - □□□□ - □ - □ - X600

- Entry is the same as standard products.

Note) Rated voltage: AC type only

SYJ

VQZ

VP

VG

VP3

Rubber Seal 3 Port/Pilot Poppet Type VP300/500/700 Series



How to Order

30-VP 3 4 4 - 1 D B - 01 A - F - Q

Conforming to CSA standard

VP series solenoid valve

Body size

3	1/4 standard
5	3/8 standard
7	1/2 standard

Type of actuation

4	In common between N.C. and N.O. (Pilot type)
---	--

Body type

2	Body ported
4	Base mounted

Valve option

Nil	Standard (Internal pilot)
R*	External pilot

* Semi-standard

Rated voltage

1	100 VAC, 50/60 Hz
2	200 VAC, 50/60 Hz
3*	110 to 120 VAC, 50/60 Hz
4*	220 VAC, 50/60 Hz
5	24 VDC
6*	12 VDC
7*	240 VAC, 50/60 Hz

* Semi-standard

Electrical entry

D	DIN terminal (With connector)
DO	DIN terminal (Without connector)

CE-compliant

Nil	—
Q	CE-compliant

Option

Nil	Without bracket
F	With bracket

* 30-VP342, 542, and 742 only

Passage symbol

A	Normally closed
B	Normally open

Thread type

Nil	Rc
F	G
N	NPT
T	NPTF

Port size

Symbol	Port size	30-VP342	30-VP542	30-VP742
Nil*	Without sub-plate	●	●	●
01	1/8	●		
02	1/4	●	●	
03	3/8		●	●
04	1/2			●

* 30-VP344, VP544, and VP744 only

Manual override

Nil	Push type
B*	Locking slotted type
C*	Locking lever type

* Semi-standard

Light/Surge voltage suppressor

Nil	None
Z*	With light/surge voltage suppressor

* Semi-standard

Caution

For safety instructions, specific product precautions, product specifications, dimensions, and model selection, refer to the individual product catalog (discontinued products). However, note that the DIN connector differs from the standard product.



VP Series

Specific Product Precautions 1

Be sure to read this before handling the products.

Refer to back page 50 for Safety Instructions and pages 3 to 9 for 3/4/5 Port Solenoid Valve Precautions.

Manual Override

⚠ Warning

Without an electric signal for the solenoid valve the manual override is used for switching the main valve. Connected actuator is started by manual operation. Use the manual override after confirming that there is no danger.

■ Non-locking push type

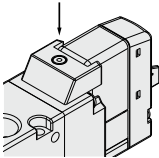

Push down on the manual override button with a small screwdriver until it stops. Release the screwdriver and the manual override will return.

■ Push-turn locking slotted type

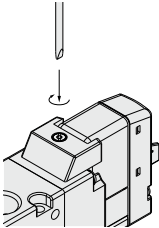

Locked condition

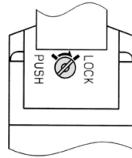

Push the manual override button with a small flat head screwdriver until it stops. Turn it in the clockwise direction at 90° to lock the manual. Turn it counterclockwise to release it.

■ Push-turn locking lever type

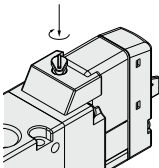

Locked condition

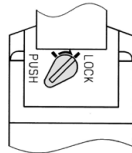

After pushing down, turn in the direction of the arrow. If it is not turned, it can be operated the same way as the non-locking type.

⚠ Caution

When locking the manual override with the push-turn locking type (D or E type), be sure to push it down before turning. Turning without first pushing it down can cause damage to the manual override and other trouble such as air leakage, etc. Do not apply excessive torque when turning the locking type manual override. (0.1 N·m)

How to Use L/M-Type Plug Connector

⚠ Caution

1. Attaching and detaching connectors

- To attach a connector, hold the lever and connector unit between your fingers and insert straight onto the pins of the solenoid valve so that the lever's pawl is pushed into the groove and locks.
- To detach a connector, remove the pawl from the groove by pushing the lever downward with your thumb, and pull the connector straight out.

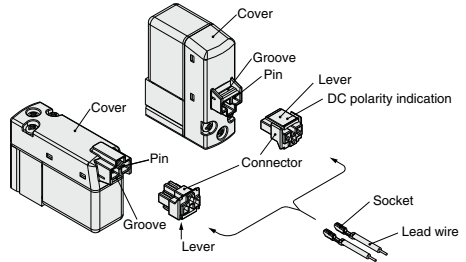

2. Crimping lead wires and sockets

Not necessary if ordering the lead wire pre-connected model. Strip 3.2 to 3.7 mm at the end of the lead wires, insert the ends of the core wires evenly into the sockets, and then crimp with a crimping tool. When this is done, take care that the coverings of the lead wires do not enter the core wire crimping area. (Please contact SMC for details on the crimping tool.)

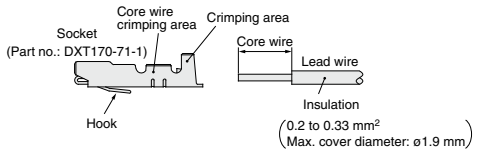

3. Attaching and detaching sockets with lead wire

• Attaching

Insert the sockets into the square holes of the connector (⊕, ⊖ indication), and continue to push the sockets all the way in until they lock by hooking into the seats in the connector. (When they are pushed in, their hooks open and they are locked automatically.) Then, confirm that they are locked by pulling lightly on the lead wires.

• Detaching

To detach a socket from a connector, pull out the lead wire while pressing the socket's hook with a stick having a thin tip (approx. 1 mm). If the socket will be used again, first spread the hook outward.

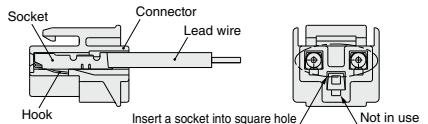

SYJ

VQZ

VP

VG

VP3



VP Series

Specific Product Precautions 2

Be sure to read this before handling the products.

Refer to back page 50 for Safety Instructions and pages 3 to 9 for 3/4/5 Port Solenoid Valve Precautions.

Plug Connector Lead Wire Length

⚠ Caution

Plug connector lead wires have a standard length of 300 mm, however, the following lengths are also available.

How to Order Connector Assembly

DC	: V200-30-4A-	
100 VAC	: V200-30-1A-	
200 VAC	: V200-30-2A-	
AC other voltages:	V200-30-3A-	

Without lead wire : V200-30-A
(With connector and 2 pcs. of socket)

● Lead wire length

Nil	300 mm
6	600 mm
10	1000 mm
15	1500 mm
20	2000 mm
25	2500 mm
30	3000 mm
50	5000 mm

How to Order

Include the connector assembly part number together with the part number for the plug connector's solenoid valve without connector.

(Example) 2000 mm lead wire length

DC	AC
VP342-5L01-01A	VP342-1L01-01A
V200-30-4A-20	V200-30-1A-20

How to Use DIN Terminal

The DIN terminal type with an IP65 enclosure is protected against dust and water, however, it must not be used in water.

⚠ Caution

Connection

- Loosen the set screw and pull the connector out of the solenoid valve terminal block.
- After removing the set screw, insert a flat head screwdriver, etc. into the notch on the bottom of the terminal block and pry it open, separating the terminal block and the housing.
- Loosen the terminal screws on the terminal block, insert the core of the lead wire into the terminal, and attach securely with the terminal screws.
In addition, when using the DC mode type with a surge voltage suppressor (polar: S and Z types), connect wires corresponding to the polarity (+ or -) that is printed on the terminal block.
- Tighten the ground nut to secure the wire.
In the case of connecting wires, select cable cords carefully because if those out of the specified range ($\phi 4.5$ to $\phi 7$) are used, it will not be able to satisfy IP65 (enclosure). Tighten the ground nut and set screw within the specified range of torque.

Changing the entry direction

After separating terminal block and housing, the cord entry direction can be changed by attaching the housing in the opposite direction.

* Make sure not to damage elements, etc., with the lead wires of the cord.

Precautions

Plug in and pull out the connector vertically without tilting to one side.

Applicable cable

Cable O.D.: $\phi 4.5$ to $\phi 7$

(Reference) 0.5 mm^2 to 1.5 mm^2 , 2-core or 3-core, equivalent to JIS C 3306

Applicable crimped terminal

O terminal: R1.25-4M that is specified in JIS C 2805

Y terminal: 1.25-3L, which is released by JST Mfg. Co., Ltd.

Stick terminal: Size 1.5 or shorter

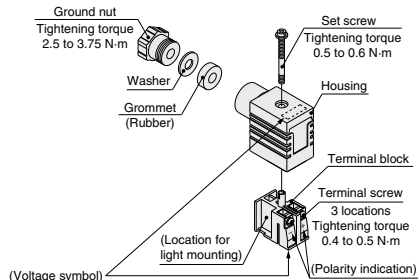



VP Series

Specific Product Precautions 3

Be sure to read this before handling the products.

Refer to back page 50 for Safety Instructions and pages 3 to 9 for 3/4/5 Port Solenoid Valve Precautions.

DIN (EN175301-803) Terminal

Y type DIN terminal corresponds to the DIN connector with terminal pitch 10 mm, which complies with EN175301-803B. Since the terminal pitch is different from the D type DIN connector, these two types are not interchangeable.

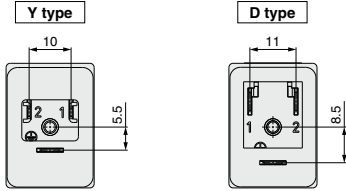

How to Order DIN Connector

Caution

● Without indicator light

DC, AC, Other voltages: V200-□-1

● With indicator light

DC
Polar type (□Z) : V200-□-3-□

Non-polar type (□U) : V200-□-5-□

● Rated voltage

05	24 VDC
06	12 VDC

AC (□Z) : V200-□-7-□

Connector specification ●

61	D type
63	Y type

● Rated voltage

01	100/110 VAC [115 VAC]
02	200/220 VAC [230 VAC]
07	240 VAC

(Note) Order no. for 24 VAC specification is V200-61-5-B.

Circuit with indicator light (Built-in connector)

DC (□U) circuit

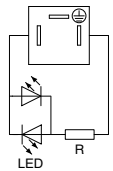

LED: Light emitting diode, R: Resistor

AC (□Z) circuit

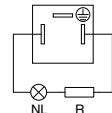

NL: Neon bulb R: Resistor

DC (□Z) circuit

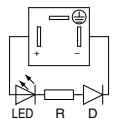

LED: Light emitting diode
D: Protective diode
R: Resistor

(Note) The 24 VAC specifications are the same as those in the DC (□U) circuit diagram.

How to Use Conduit Terminal

Caution

Connection

- Loosen the set screw and remove the terminal block cover from the terminal block.
- Loosen the terminal screws on the terminal block, insert the core of the lead wire or crimped terminal into the terminal, and attach securely with the terminal screws.
In addition, when using the DC mode type with a surge voltage suppressor (polar: S and Z types), connect wires to terminal 1 and 2 corresponding to the polarity (+ or -) as shown on the right figure.
- Secure the cord by fastening the ground nut.



In the case of connecting wires, select cable cords carefully because if those out of the specified range ($\phi 4.5$ to $\phi 7$) are used, it will not be able to satisfy IP65 (enclosure). Tighten the ground nut and set screw within the specified range of torque.

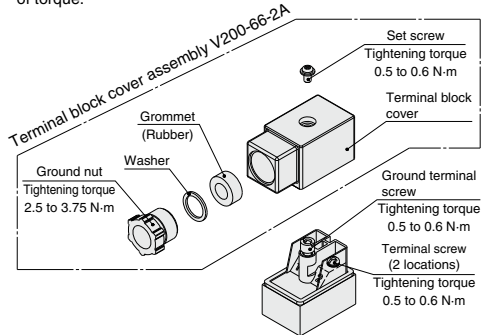

Applicable cable

Cable O.D.: $\phi 4.5$ to $\phi 7$

(Reference) 0.5 mm^2 to 1.5 mm^2 , 2-core or 3-core, equivalent to JIS C 3306

Applicable crimped terminal

O terminal: Equivalent to R1.25-3 that is specified in JIS C 2805
Y terminal: Equivalent to 1.25-3, which is released by JST Mfg. Co., Ltd.

* Use O terminal when a ground terminal is used.

SYJ

VQZ

VP

VG

VP3



VP Series

Specific Product Precautions 4

Be sure to read this before handling the products.

Refer to back page 50 for Safety Instructions and pages 3 to 9 for 3/4/5 Port Solenoid Valve Precautions.

Light/Surge Voltage Suppressor

⚠ Caution

<DC>

■ Polar type

With surge voltage suppressor (□S) Polarity protection diode

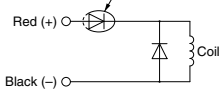

● Grommet or L/M-type plug connector

With light/surge voltage suppressor (□Z) Polarity protection diode

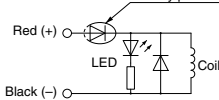

● DIN or Conduit terminal

With light/surge voltage suppressor (□Z) Polarity protection diode

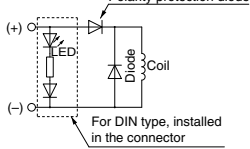

■ Non-polar type

With surge voltage suppressor (□R)

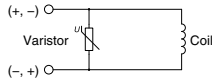

● Grommet or L/M-type plug connector

With light/surge voltage suppressor (□U)

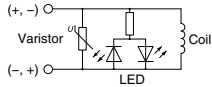

● DIN or Conduit terminal

With light/surge voltage suppressor (□U) Varistor

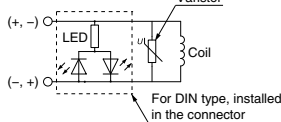

- Please connect correctly the lead wires to + (positive) and - (negative) indications on the connector. (For non-polar type, the lead wires can be connected to either one.)
- When the valve with polarity protection diode is used, the voltage will drop by approx. 1 V. Therefore, pay attention to the allowable voltage fluctuation (For details, refer to the solenoid specification of each type of valve).
- Solenoids, whose lead wires have been pre-wired: + (positive) side red and - (negative) side black.

■ With power saving circuit

Power consumption is decreased by approx. 1/3 by reducing the wattage required to hold the valve in an energized state. (Effective energizing time is over 40 ms at 24 VDC.) Refer to the electrical power waveform as shown below.

<Electrical power waveform of energy saving type>

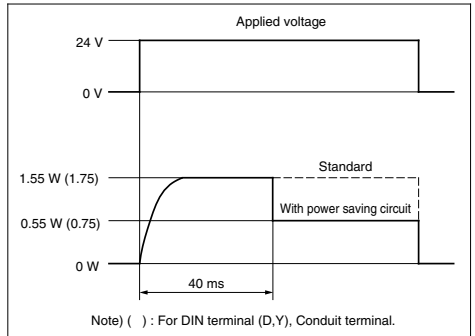

- Since the voltage will drop by approx. 0.5 V due to the transistor, pay attention to the allowable voltage fluctuation. (For details, refer to the solenoid specifications of each type of valve.)

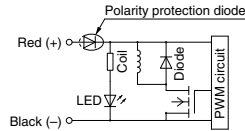

<AC>

There is no S option, since a rectifier prevents surge voltage generation.

● Grommet or L/M-type plug connector

With light/surge voltage suppressor (□Z)

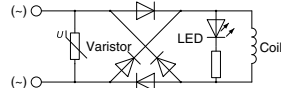

● DIN or Conduit terminal

With light/surge voltage suppressor (□Z)

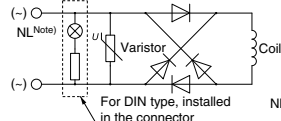

Note) LED for 24 VAC.

NL: Neon bulb



Low Wattage Specification (VP300/500) Specific Product Precautions 5

Be sure to read this before handling the products.

Refer to back page 50 for Safety Instructions and pages 3 to 9 for 3/4/5 Port Solenoid Valve Precautions.

Manual Override

⚠ Warning

1. Non-locking push type [Standard]

Press in the direction of the arrow.

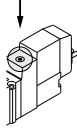

2. Push-turn locking slotted type [D type]

After pushing down, turn in the direction of the arrow. If it is not turned, it can be operated the same way as the non-locking push type.

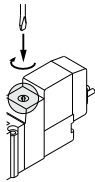

Locked position



⚠ Caution

When operating the D type, use a watchmakers' screwdriver and turn lightly.

[Torque: Less than 0.1 N·m]

3. Push-turn locking lever type [E type]

After pushing down, turn in the direction of the arrow. If it is not turned, it can be operated the same way as the non-locking push type.

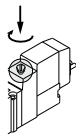

Locked position

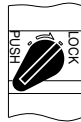

⚠ Caution

When locking the manual override with the push-turn locking type (D or E type), be sure to push it down before turning. Turning without first pushing it down can cause damage to the manual override and other trouble such as air leakage, etc.

Solenoid Valve for 200/220 VAC Specification

⚠ Warning

AC specification solenoid valves with grommet or L/M-type plug connector have a built-in rectifier circuit in the pilot section to operate the DC coil. With 200/220 VAC specification pilot valves, this built-in rectifier generates heat when energized. The surface may become hot depending on the energized condition; therefore, do not touch the solenoid valves.

How to Use L/M-Type Plug Connector

⚠ Caution

1. Connector attachment/detachment

- To attach a connector, hold the lever and connector unit between your fingers and insert straight onto the pins of the solenoid valve so that the lever's pawl is pushed into the groove and locks.
- To detach a connector, remove the pawl from the groove by pushing the lever downward with your thumb, and pull the connector straight out.

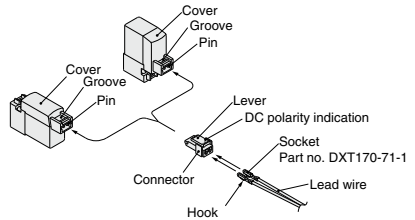

2. Crimping lead wire and socket connection

Strip 3.2 to 3.7 mm at the end of the lead wires, insert the ends of the core wires evenly into the sockets, and then crimp with a crimping tool. When this is done, take care that the coverings of the lead wires do not enter the core wire crimping area. (Please contact SMC for the dedicated crimping tools.)

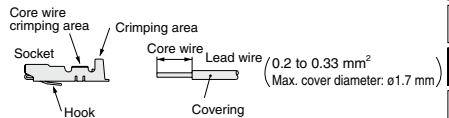

3. Socket with lead wire attachment/detachment

● Attachment

Insert the sockets into the square holes of the connector (with ⊕, ⊖ indication), and continue to push the sockets all the way in until they lock by hooking into the seats in the connector. (When they are pushed in, their hooks open and they are locked automatically.) Then, confirm that they are locked by pulling lightly on the lead wires.

● Detachment

To detach a socket from a connector, pull out the lead wire while pressing the socket's hook with a stick having a thin tip (approx. 1 mm). If the socket will be used again, first spread the hook outward.

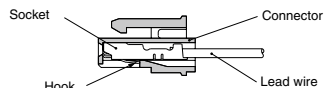

SYJ

VQZ

VP

VG

VP3



Low Wattage Specification (VP300/500) Specific Product Precautions 6

Be sure to read this before handling the products.

Refer to back page 50 for Safety Instructions and pages 3 to 9 for 3/4/5 Port Solenoid Valve Precautions.

Plug Connector Lead Wire Length

⚠ Caution

Plug connector lead wires have a standard length of 300 mm, however, the following lengths are also available.

How to Order Connector Assembly

DC: **SY100-30-4A** - []

100 VAC: **SY100-30-1A** - []

200 VAC: **SY100-30-2A** - []

Other AC voltages: **SY100-30-3A** - []

Without lead wire: **SY100-30-A**

(With a connector and 2 sockets)

How to Order

Specify the connector assembly part number together with the part number for the plug connector type solenoid valve without connector.

(Example) Lead wire length: 2000 mm

DC	AC
VP342Y-5LO1-01	VP342Y-1LO1-01
SY100-30-4A-20	SY100-30-1A-20

Lead wire length

Nil	300 mm
6	600 mm
10	1000 mm
15	1500 mm
20	2000 mm
25	2500 mm
30	3000 mm
50	5000 mm

Light/Surge Voltage Suppressor

⚠ Caution

<DC>

● Grommet or L/M-type plug connector

■ Polar type

With surge voltage suppressor (□S)

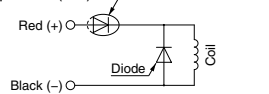

With light/surge voltage suppressor (□Z)

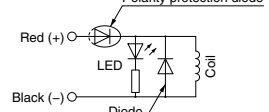

■ Non-polar type

With surge voltage suppressor (□R)

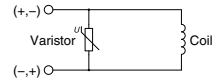

With light/surge voltage suppressor (□U)

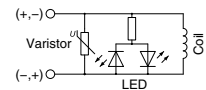

● DIN terminal

■ Non-polar type

With surge voltage suppressor (□S)

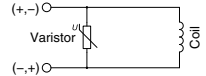

With light/surge voltage suppressor (□Z)

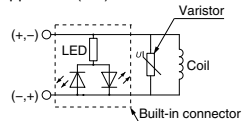



Low Wattage Specification (VP300/500) Specific Product Precautions 6-1

Be sure to read this before handling the products.

Refer to back page 50 for Safety Instructions and pages 3 to 9 for 3/4/5 Port Solenoid Valve Precautions.

Light/Surge Voltage Suppressor

⚠ Caution

<AC>

S type is not available, since a rectifier prevents surge voltage generation.

●Grommet or L/M-type plug connector

With light/surge voltage suppressor (□Z)

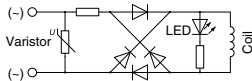

●DIN terminal

With light/surge voltage suppressor (□Z)

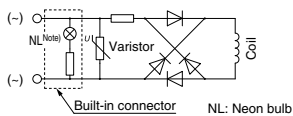

Note) LED for 24 VAC.

Residual voltage of the surge voltage suppressor

Note) If a varistor or diode surge voltage suppressor is used, there is some residual voltage to the protection element and rated voltage. Therefore, refer to the table below and pay attention to the surge voltage protection on the controller side. Also, since the response time does change, refer to the specifications on page 1279.

Residual Voltage

Surge voltage suppressor	DC		AC
	24	12	
Diode	Approx. 1 V		Approx. 1 V
Varistor	Approx. 47 V	Approx. 32 V	—

SYJ

VQZ

VP

VG

VP3



Low Wattage Specification (VP300/500) Specific Product Precautions 7

Be sure to read this before handling the products.

Refer to back page 50 for Safety Instructions and pages 3 to 9 for 3/4/5 Port Solenoid Valve Precautions.

How to Use DIN Terminal

⚠ Caution

Connection

- Loosen the holding screw and pull the connector out of the solenoid valve terminal block.
- After removing the holding screw, insert a flat head screwdriver, etc. into the notch on the bottom of the terminal block and pry it open, separating the terminal block and the housing.
- Loosen the terminal screws (slotted screws) on the terminal block, insert the cores of the lead wires into the terminals according to the connection method, and fasten them securely with the terminal screws.
- Secure the cord by fastening the gland nut.

⚠ Caution

When making connections, take note that using other than the supported size (ø3.5 to ø7) heavy duty cord will not satisfy IP65 (enclosure) standards. Also, be sure to tighten the gland nut and holding screw within their specified torque ranges.

Changing the entry direction

After separating the terminal block and housing, the cord entry can be changed by attaching the housing in the desired direction (4 directions at 90° intervals).

* When equipped with a light, be careful not to damage the light with the cord's lead wires.

Precautions

Plug in and pull out the connector vertically without tilting to one side.

Compatible cable

Cord O.D.: ø3.5 to ø7

(Reference) 0.5mm², 2-core or 3-core, equivalent to JIS C 3306

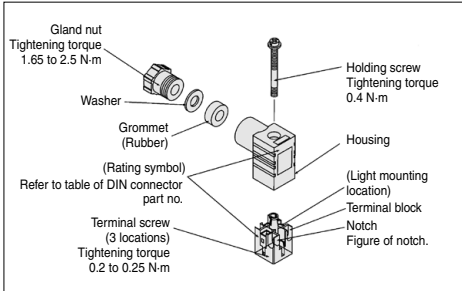

Type "Y"

DIN connector type Y is a DIN connector that conforms to the DIN pilot 8-mm standard.

- D type DIN connector with 9.4 mm pitch between terminals is not interchangeable.
- To distinguish from the D type DIN connector, "N" is listed at the end of voltage symbol. (For connector parts without lights, "N" is not indicated. Please refer to the name plate to distinguish.)
- Dimensions are completely the same as D type DIN connector.

DIN Connector Part No.

⚠ Caution

DIN terminal (D)

Without indicator light	SY100-61-1
-------------------------	------------

With indicator light

Rated voltage	Voltage symbol	Part no.
24 VDC	24 V	SY100-61-3-05
12 VDC	12 V	SY100-61-3-06
100 VAC	100 V	SY100-61-2-01
200 VAC	200 V	SY100-61-2-02
110 VAC	110 V	SY100-61-2-03
220 VAC	220 V	SY100-61-2-04

DIN terminal (Y)

Without indicator light

Rated voltage	Voltage symbol	Part no.
Common to all voltages	None	SY100-82-1

With indicator light

Rated voltage	Voltage symbol	Part no.
24 VDC	24 V	SY100-82-3-05
12 VDC	12 V	SY100-82-3-06
100 VAC	100 V	SY100-82-2-01
200 VAC	200 V	SY100-82-2-02
110 VAC (115 VAC)	110 V	SY100-82-2-03
220 VAC (230 VAC)	220 V	SY100-82-2-04

Circuit diagram with light

AC circuit diagram

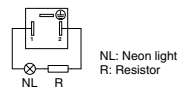

DC circuit diagram

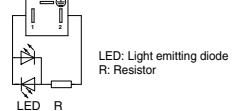

Pilot Valve

The mounting of the low wattage type pilot valve is not interchangeable with that of the standard type. Additionally, be aware that the pilot valve cannot be replaced.

SYJ

VQZ

VP

VG

VP3



Body Ported/Base Mounted Specification Specific Product Precautions 8

Be sure to read this before handling the products.

Refer to back page 50 for Safety Instructions and pages 3 to 9 for 3/4/5 Port Solenoid Valve Precautions.

Light/Surge Voltage Suppressor

⚠ Caution

Residual voltage of the surge voltage suppressor

Note) If a varistor or diode surge voltage suppressor is used, there is some residual voltage to the protection element and rated voltage. Therefore, refer to the table below and pay attention to the surge voltage protection on the controller side. Also, since the response time does change, refer to the specifications on pages 1265 and 1272.

Residual Voltage

Surge voltage suppressor	DC		AC
	24	12	
S, Z	Approx. 1 V		Approx. 1 V
R, U	Approx. 47 V	Approx. 32 V	—

Type of Actuation Changing

⚠ Warning

When changing the actuation or restarting the valve after the change, make sure that safety is fully assured and pay great attention.

Example: Changing from N.C. to N.O.

1) Base mounted

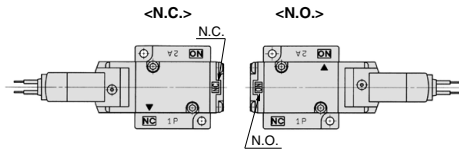

1. Remove the body from the sub-plate and reset the "▼" mark on the body corresponding to the "N.O." mark on the sub-plate as shown in the figure above.
2. Remove the end plate from the body and rotate the end plate by 180° so that the "N.O." mark on the end plate is at the top of the valve.

* It is not necessary to change the piping when this is done.

2) Body ported

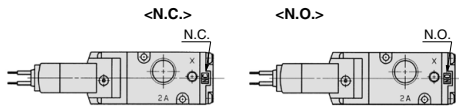

- Remove the end plate from the body and rotate the end plate by 180° to correspond the "N.O." mark on the end plate to the top of the valve.

* Piping should be arranged as follows.

Type of actuation \ Port	1P	2A	3R
N.C.	Inlet side	Outlet side	Exhaust side
N.O.	Exhaust side	Outlet side	Inlet side

Precautions when replacing the old VP series with new VP series

⚠ Caution

When replacing the built-in valve with the new VP series if the old VP series uses the external pilot manifold, be aware that the valve selection becomes different.

Manifold model no.	Mounting valve	
	New VP	Old VP
VV3P□ ⁴¹ / ₄₂ □□-□□ (Internal pilot)	Internal pilot	Internal pilot
VV3P□ ⁴³ R□□-□□ (External pilot)	External pilot	Internal pilot

<How to distinguish the external pilot manifold>

When the piping is connected to the external pilot port, this manifold is the external pilot manifold.

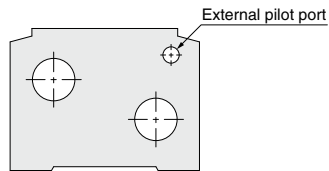

One-touch Fittings

⚠ Caution

When fittings are used, they may interfere with one another depending on their types and sizes. Therefore, the dimensions of the fittings to be used should first be confirmed in their respective catalogs.

Fittings whose compliance with the VP series is already confirmed are stated below. If the fitting within the applicable range is selected, there will not be any interference.

Applicable Fittings: KQ2H, KQ2S series

Series	Piping port	Port size	Applicable tubing O.D.					
			ø3.2	ø4	ø6	ø8	ø10	ø12
VP(A)300	1P, 2A, 3R	1/8, 1/4	[Shaded]					
	X	M5	[Shaded]					
VP(A)500	1P, 2A, 3R	1/4, 3/8	[Shaded]					
	X	1/8	[Shaded]					
VP(A)700	1P, 2A, 3R	3/8, 1/2	[Shaded]					
	X	1/8	[Shaded]					
VV3P(A)3 Manifold base	1P, 2A, 3R	1/4	[Shaded]					
	X	M5	[Shaded]					
VV3P(A)5 Manifold base	1P, 2A, 3R	3/8	[Shaded]					
	X	M5	[Shaded]					
VV3P(A)7 Manifold base	1P, 2A, 3R	1/2	[Shaded]					
	X	1/8	[Shaded]					