

Cylinder with Lock

MNB Series

ø32, ø40, ø50, ø63, ø80, ø100

A locking cylinder ideal for intermediate stops, emergency stops and drop prevention.

Simple construction

A force magnifying mechanism is employed based on the wedge effect of the taper ring and steel balls.

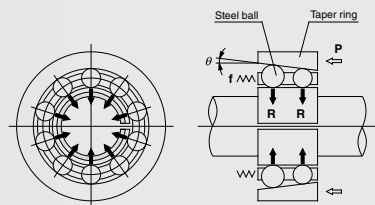

Maximum piston speed: 1000 mm/s

It can be used at 50 to 1000 mm/s provided that it is within the allowable kinetic energy range.

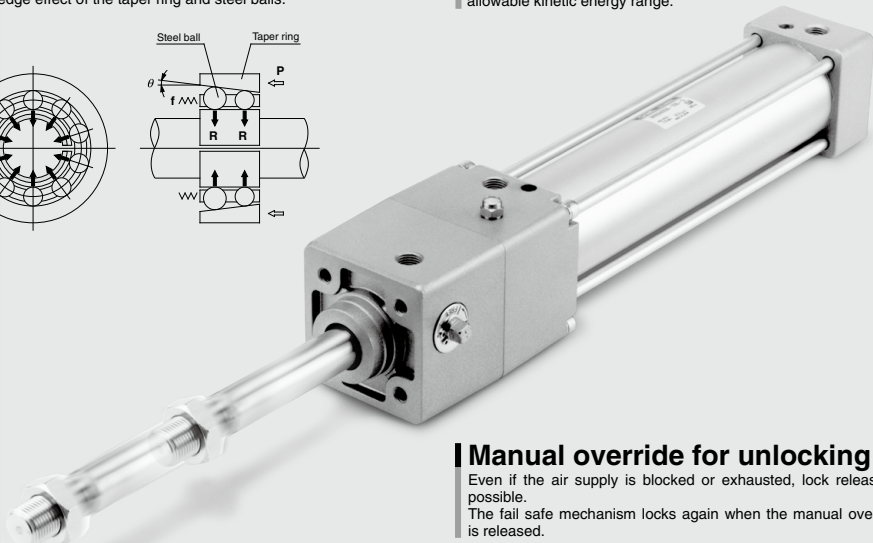

Manual override for unlocking

Even if the air supply is blocked or exhausted, lock release is possible.

The fail safe mechanism locks again when the manual override is released.

High locking efficiency

Greater locking efficiency as well as stable locking and unlocking operation has been achieved by arranging a large number of steel ball bearings in circular rows. (Unlocking pressure of 0.25 MPa 0.05 MPa lower than conventional SMC products) In addition, both alignability and stable locking force with respect to piston rod eccentricity are obtained by allowing the taper ring to float.

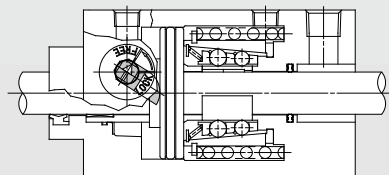

High reliability and stable holding force

Outstanding durability and stable holding force are maintained by the use of a brake shoe having superior wear resistance, which has also been substantially lengthened (double the conventional SMC product).

Design minimizes the influences of unlocking air quality

A construction which is strong against moisture and drainage in the compressed air has been realized by separating the locking mechanism and the unlocking chamber.

Can be locked in both directions

An equal holding force can be obtained on either reciprocating stroke of the cylinder.

Series Variations

Series	Action	Type	Standard variations	Bore size (mm)	Lock holding force (N)	Max. stroke (mm)
			With rod boot			
Cylinder with lock MNB series	Double acting	Single rod MNB series Double rod MNBW series	32	552	700	
			40	882	800	
			50	1370	1000	
			63	2160	1000	
			80	3430	1000	
			100	5390		

CLJ2

CLM2

CLG1

CL1

MLGC

CNG

MNB

CNA2

CNS

CLS

CLQ

RLQ

MLU

MLGP

ML1C

D-□

-X□

MNB Series Model Selection

Precautions on Model Selection

⚠ Caution

- In order that the originally selected maximum speed shall not be exceeded, be certain to use a speed controller to adjust the total movement distance of the load so that movement takes place in no less than the applicable movement time.
The movement time is the time that is necessary for the load to travel the total movement distance from the start without any intermediate stops.
- In cases where the cylinder stroke and the movement distance of the load are different (double speed mechanism, etc.), use the movement distance of the load for selection purposes.

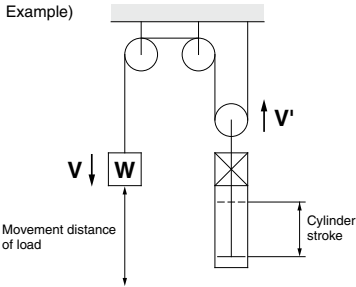

- The following selection example and procedures are based on use at the intermediate stop (including emergency stops during operation). However, when the cylinder is in a locked state, kinetic energy does not act upon it. Under these conditions, use the load mass at the maximum speed (V) of 100 mm/s shown in graphs (5) to (7) on page 889 depending on the operating pressure and select models.

Selection Example

- Load mass : $m = 50 \text{ kg}$
- Movement distance : $st = 500 \text{ mm}$
- Movement time : $t = 2 \text{ s}$
- Load condition : Vertical downward = Load in direction of rod extension
- Operating pressure : $P = 0.4 \text{ MPa}$

Step (1): From graph (1) find the maximum movement speed of the load

\therefore Maximum speed $V \cong 350 \text{ mm/s}$.

Step (2): Select graph (6) based upon the load conditions and operating pressure, and then from the intersection of the maximum speed $V = 350 \text{ mm/s}$ found in Step (1), and the load mass $m = 50 \text{ kg}$.

$\therefore \phi 63 \rightarrow$ select a MNB63 or larger bore size.

Step (1) Find the maximum load speed V .

Find the maximum load speed: V (mm/s) from the load movement time: t (s) and the movement distance: st (mm).

Graph (1)

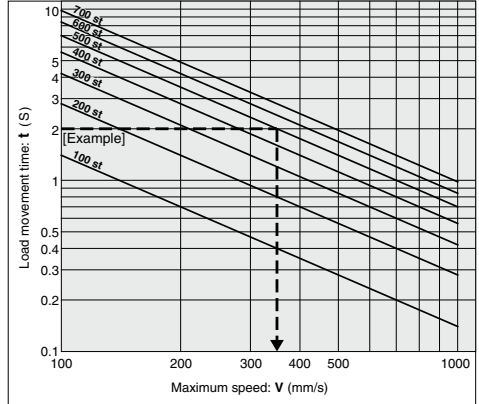

Step (2) Find the bore size.

Select a graph based upon the load condition and operating pressure, and then find the point of intersection for the maximum speed found in Step (1) and the load mass. Select the bore size on the above the point of intersection.

Load Condition

Operating pressure

Load in the direction at the right angle to rod

(* Being held by a guide)

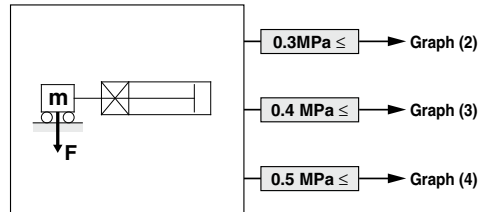

Load in the direction of rod extension

Load in the direction of rod retraction

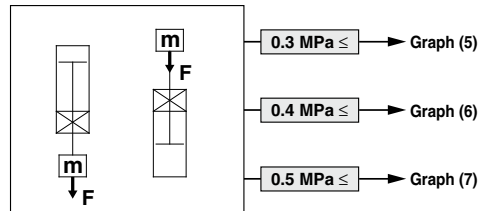

Selection Graph

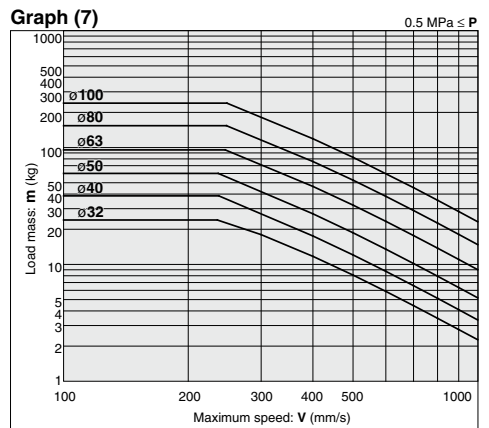
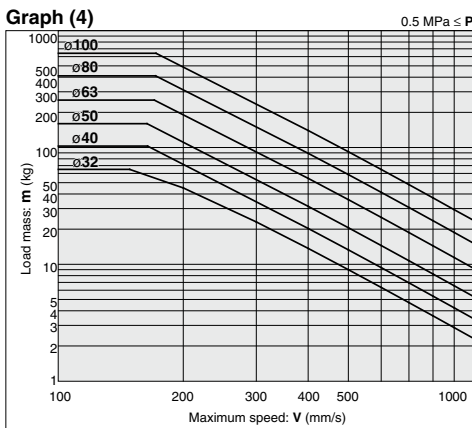
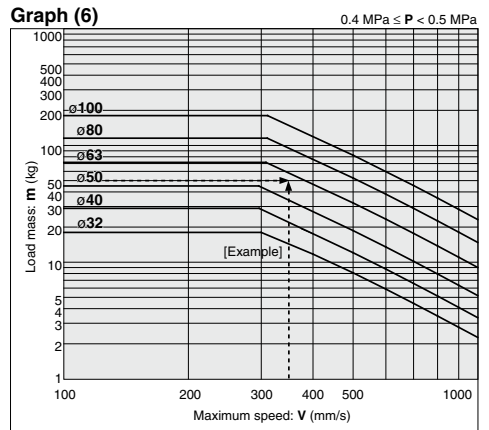
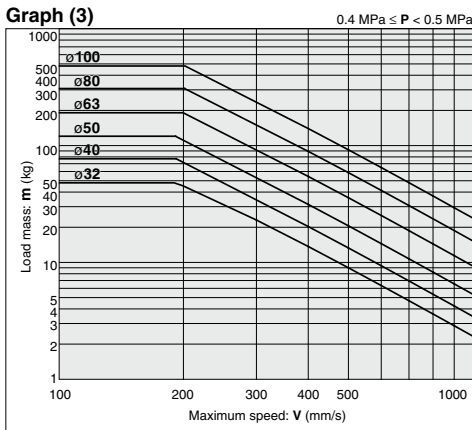
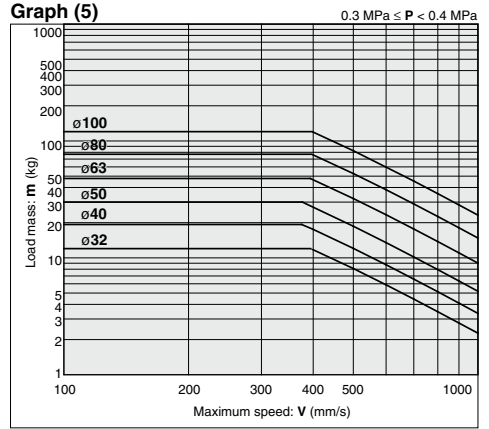
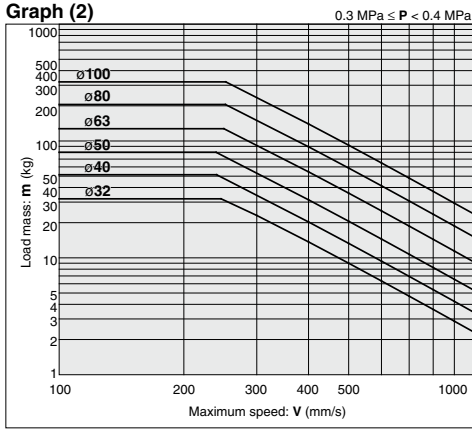

- CLJ2
- CLM2
- CLG1
- CL1
- MLGC
- CNG
- MNB**
- CNA2
- CNS
- CLS
- CLQ
- RLQ
- MLU
- MLGP
- ML1C

- D-□
- X□

Cylinder with Lock

Double Acting, Single Rod

MNB Series

ø32, ø40, ø50, ø63, ø80, ø100

How to Order

MNB L 50 - 100 - D -

With auto switch MDNB L 50 - 100 - D - M9BW -

With auto switch
(Built-in magnet)
Mounting type

B	Basic type
L	Axial foot type
F	Rod side flange type
G	Head side flange type
C	Single clevis type
D	Double clevis type

Bore size

32	32 mm
40	40 mm
50	50 mm
63	63 mm
80	80 mm
100	100 mm

Port thread type

Nil	Rc
TN	NPT
TF	G

Cylinder stroke (mm)

Refer to page 891 for the standard stroke.

Locking direction

D	Both directions
---	-----------------

Auto switch

Nil	Without auto switch
-----	---------------------

Number of auto switch

Nil	2 pcs.
S	1 pc.
n	"n" pcs.

Made to Order
Refer to page 891 for details.

With rod boot

Nil	None
J	Nylon tarpaulin
K	Heat resistant tarpaulin

Built-in Magnet Cylinder Model
If a built-in magnet cylinder without an auto switch is required, there is no need to enter the symbol for the auto switch.
(Example) MDNBL40-100-D

Locking direction
* For the applicable auto switch model, refer to the table below.

Applicable Auto Switches

Refer to pages 1119 to 1245 for further information on auto switches.

Type	Special function	Electrical entry	Indicator light	Wiring (Output)	Load voltage			Auto switch model		Lead wire length (m)					Pre-wired connector	Applicable load
					DC	AC		Tie-rod mounting	Band mounting	0.5 (Nil)	1 (M)	3 (L)	5 (Z)			
Solid state auto switch	—	Grommet	No	3-wire (NPN)	24 V	5 V, 12 V	—	M9N	—	●	●	○	○	○	IC circuit	Relay, PLC
				3-wire (PNP)				—	●	●	○	○				
		2-wire	—	●	●	○	○									
		M9B	—	●	●	○	○									
	Terminal conduit	Yes	3-wire (NPN)	24 V	5 V, 12 V	—	G39	—	●	●	○	○	○	—		
			2-wire				—	●	●	○	○					
	Diagnostic indication (2-color indicator)	Grommet	Yes	3-wire (NPN)	24 V	5 V, 12 V	—	M9NW	—	●	●	○	○	IC circuit		
				3-wire (PNP)				—	●	●	○	○				
				2-wire				—	●	●	○	○				
				M9BW				—	●	●	○	○				
M9PA*1				—				○	○	●	○	○				
M9BA*1				—				○	○	●	○	○				
Water resistant (2-color indicator)	Grommet	Yes	3-wire (NPN)	24 V	5 V, 12 V	—	F59F	—	●	—	●	○	○	IC circuit		
3-wire (PNP)			—				●	—	●	○	○					
With diagnostic output (2-color indicator)	Grommet	Yes	4-wire (NPN)	24 V	5 V, 12 V	—	P3DWA	—	●	—	●	○	—			
Magnetic field resistant (2-color indicator)			2-wire (Non-polar)				—	—	—	—	—					
Reed auto switch	—	Grommet	Yes	3-wire (NPN equivalent)	24 V	12 V	—	A96	—	●	—	●	—	IC circuit		
				100 V				A93	—	●	●	●	—			
				100 V or less				A90	—	●	—	●	—			
				100 V, 200 V				A54	—	●	—	●	—			
		Terminal conduit	Yes	No	2-wire	24 V	12 V	—	A64	—	●	—	●	—	—	
									—	A33	—	—	—	—		—
		DIN terminal	Grommet	Yes	2-wire	24 V	12 V	—	—	A34	—	—	—	—	PLC	
									—	A44	—	—	—	—		—
Diagnostic indication (2-color indicator)	Grommet	Yes	2-wire	24 V	—	—	A59W	—	●	—	●	—	Relay, PLC			

*1 Water resistant type auto switches can be mounted on the above models, but in such case SMC cannot guarantee water resistance. Consult with SMC regarding water resistant types with the above model numbers.

* Lead wire length symbols: 0.5 m Nil (Example) M9NW
1 m M (Example) M9NWM
3 m L (Example) M9NWL
5 m Z (Example) M9NWZ

* Solid state auto switches marked with "○" are produced upon receipt of order.

* Since there are other applicable auto switches than listed, refer to page 911 for details.

* D-A9□/M9□/P3DWA□ auto switches are shipped together (not assembled). (Only auto switch brackets are assembled at the time of shipment for D-A9□ and M9□.)



Cylinder Specifications

Bore size (mm)	32	40	50	63	80	100
Lubrication	Not required (Non-lube)					
Fluid	Air					
Proof pressure	1.5 MPa					
Max. operating pressure	1.0 MPa					
Min. operating pressure	0.08 MPa					
Piston speed	50 to 1000 mm/s*					
Ambient and fluid temperature	Without auto switch: -10 to 70°C (No freezing) With auto switch: -10 to 60°C (No freezing)					
Cushion	Air cushion on both ends					
Stroke length tolerance	Up to 250: $^{+1.0}_0$; 251 to 1000: $^{+1.4}_0$					
Mounting	Basic type, Axial foot type, Rod side flange type, Head side flange type, Single clevis type, Double clevis type					

* Load limits exist depending upon piston speed when locked, mounting direction and operating pressure.



Made to Order Specifications

[Click here for details](#)

Symbol	Specifications
-XA□	Change of rod end shape
-XC35	With coil scraper

Refer to pages 908 to 911 for cylinders with auto switches.

- Minimum auto switch mounting stroke
- Proper auto switch mounting position (detection at stroke end) and mounting height
- Operating range
- Auto switch mounting bracket: Part no.

Lock Specifications

Bore size (mm)	32	40	50	63	80	100
Locking action	Spring locking (Exhaust locking)					
Unlocking pressure	0.25 MPa or more					
Lock starting pressure	0.20 MPa or less					
Max. operating pressure	1.0 MPa					
Locking direction	Both directions					
Holding force (maximum static load) N*	552	882	1370	2160	3430	5390

* The holding force (max. static load) shows the maximum capability and does not show the normal holding capability. So, select an appropriate cylinder while referring to page 888.

Standard Stroke For cases with auto switches, refer to the table of minimum strokes for /mounting of auto switches (page 910).

Bore size (mm)	Standard stroke (mm) ⁽¹⁾	Maximum manufacturable stroke (mm)
32, 40	25, 50, 75, 100, 125, 150, 175, 200, 250, 300, 350, 400, 450, 500	ø32 : 700 ø40 : 800
50, 63	25, 50, 75, 100, 125, 150, 175, 200, 250, 300, 350, 400, 450, 500, 600	1000
80, 100	25, 50, 75, 100, 125, 150, 175, 200, 250, 300, 350, 400, 450, 500, 600, 700, 800	1000

Note 1) Intermediate strokes other than the above are produced upon receipt of order. Spacers are not used for intermediate strokes.

Note 2) When exceeding the stroke range for each bracket, determine the maximum strokes referring to the Selection Table (Best Pneumatics No. 2-1).

Stopping Accuracy

Lock type	Piston speed (mm/s)			
	100	300	500	1000
Spring locking	±0.3	±0.6	±1.0	±2.0

Condition: Lateral, Supply pressure P = 0.5 MPa

Load mass Upper limit of allowed value

Solenoid valve for locking mounted on the unlocking port

Maximum value of stopping position dispersion from 100 measurements

CLJ2

CLM2

CLG1

CL1

MLGC

CNG

MNB

CNA2

CNS

CLS

CLQ

RLQ

MLU

MLGP

ML1C

D-□

-X□

MNB Series

Mounting Bracket Part No.

Bore size (mm)	32	40	50	63	80	100
Foot ⁽¹⁾	MB-L03	MB-L04	MB-L05	MNB-L06*	MB-L08	MB-L10
Flange	MNB-F03*	MNB-F04*	MNB-F05*	MNB-F06*	MB-F08	MB-F10
Single clevis	MB-C03	MB-C04	MB-C05	MB-C06	MB-C08	MB-C10
Double clevis	MB-D03	MB-D04	MB-D05	MB-D06	MB-D08	MB-D10

Note 1) When ordering foot bracket, order 2 pieces per cylinder.

Note 2) Accessories for each mounting bracket are as follows.

Foot, Flange, Single clevis: Body mounting bolts

Double clevis: Clevis pin, Cotter pin, Flat washer, Body mounting bolts

Note 3) All are common to the MB series air cylinders, except the sections marked with a "*".

Rod Boot Material

Symbol	Rod boot material	Max. ambient temperature
J	Nylon tarpaulin	20°C
K	Heat resistant tarpaulin	110°C*

* Maximum ambient temperature for the rod boot itself.

Accessory

Mounting		Basic type	Foot type	Rod side flange type	Head side flange type	Single clevis type	Double clevis type
Standard equipment	Rod end nut	●	●	●	●	●	●
	Clevis pin	—	—	—	—	—	●
Option	Single knuckle joint	●	●	●	●	●	●
	Double knuckle joint (With pin)	●	●	●	●	●	●
	With rod boot	●	●	●	●	●	●

Single Rod Weight/Aluminum Tube

Bore size (mm)		32	40	50	63	80	100
Basic weight	Basic type	1.20	1.72	2.76	4.06	6.85	10.26
	Foot type	1.30	1.84	2.94	4.32	7.28	10.85
	Flange type	1.44	2.04	3.29	4.80	8.30	13.57
	Single clevis type	1.45	1.98	3.10	4.69	7.96	13.43
	Double clevis type	1.46	1.99	3.19	4.85	8.25	13.95
Additional weight per each 50 mm of stroke	All mounting brackets	0.11	0.16	0.26	0.27	0.42	0.56
	Accessory	0.15	0.23	0.26	0.26	0.60	0.83
	Double knuckle (with pin)	0.22	0.37	0.43	0.43	0.87	1.27

Calculation:

(Example) **MNBB32-100-D** (Basic type, ø32, 100 st)

• Basic weight:.....1.20 (Basic type, ø32)

• Additional weight 0.11/50 stroke

• Cylinder stroke 100 stroke

$$1.20 + 0.11 \times 100/50 = 1.42 \text{ kg}$$

Construction Principle

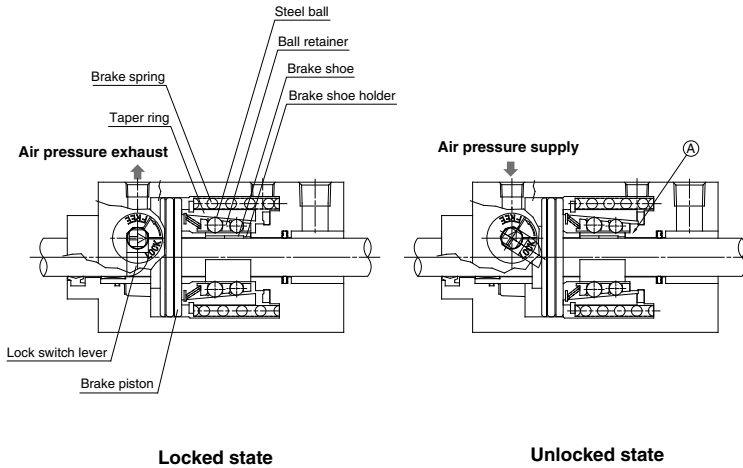

Spring locking (Exhaust locking)

The spring force which acts upon the taper ring is magnified by a wedge effect, and is conveyed to all of the numerous steel balls which are arranged in two circles. These act on the brake shoe holder and brake, which locks the piston rod by tightening against it with a large force.

Unlocking is accomplished when air pressure is supplied to the unlocking port. The brake piston and taper ring oppose the spring force, moving to the right side, and the ball retainer strikes the cover section A. The braking force is released as the steel balls are removed from the taper ring by the ball retainer.

CLJ2
CLM2
CLG1
CL1
MLGC
CNG
MNB
CNA2
CNS
CLS
CLQ
RLQ
MLU
MLGP
ML1C

D-□
-X□

MNB Series

Construction

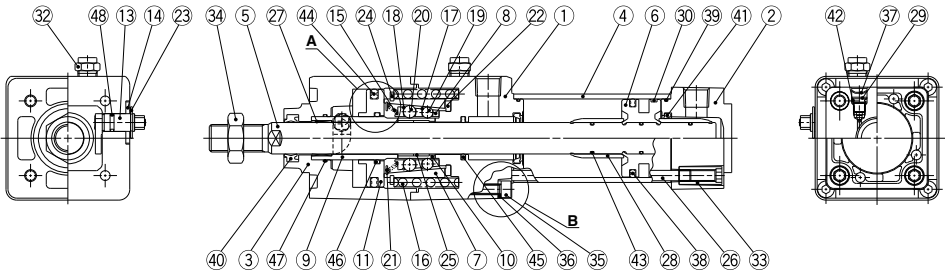

A section

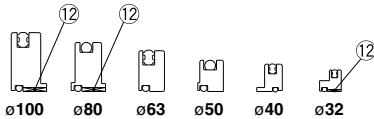

B section

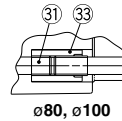

Component Parts

No.	Description	Material	Note
①	Rod cover	Aluminum alloy	Hard anodized and metallic painted
②	Head cover	Aluminum die-casted	Chromated and metallic painted
③	Cover	Aluminum alloy	Hard anodized and metallic painted
④	Cylinder tube	Aluminum alloy	Hard anodized
⑤	Piston rod	Carbon steel	Hard chrome plated
⑥	Piston	Aluminum alloy	Chromated
⑦	Taper ring	Carbon steel	Heat treated
⑧	Ball retainer	Special resin	
⑨	Piston guide	Carbon steel	Zinc chromated
⑩	Brake shoe holder	Special steel	
⑪	Release piston	Aluminum alloy	Chromated
	ø32, ø80, ø100 ø40, ø50, ø63		Hard anodized
⑫	Release piston bushing	Steel + Special resin	ø32, ø80, ø100 only
⑬	Unlocking cam	Chromium molybdenum steel	Glossy chromated
⑭	Washer	Carbon steel	Colorless zinc chromated
⑮	Retainer pre-load spring	ø32	Steel wire Zinc chromated
		ø40 to ø100	Stainless steel wire
⑯	Brake spring	Steel wire	Zinc chromated
⑰	Clip A	Stainless steel	
⑱	Clip B	Stainless steel	
⑲	Steel ball A	Carbon steel	
⑳	Steel ball B	Carbon steel	
㉑	Tooth ring	Stainless steel	
㉒	Bumper	Polyurethane rubber	
㉓	Type C retaining ring for unlocking cam shaft	Carbon steel	
㉔	Type C retaining ring for taper ring	Carbon steel	
㉕	Brake shoe	Babbitt	
㉖	Tie-rod	Carbon steel	Zinc chromated
㉗	Bushing	Bearing alloy	
㉘	Cushion ring	Aluminum alloy	Anodized

Component Parts

No.	Description	Material	Note
㉙	Cushion valve	Steel wire	
㉚	Wear ring	Resin	
㉛	Unit holding tie-rod	Carbon steel	Chromated ø80, ø100 only
㉜	BC element		
㉝	Tie-rod nut	Carbon steel	
㉞	Rod end nut	Carbon steel	
㉟	Hexagon socket head cap screw	Chromium molybdenum steel	ø32 to ø63
㊱	Spring washer for hex. socket head cap screw	Steel wire	ø32 to ø63
㊲	Retaining ring	Spring steel	
㊳	Piston seal	NBR	
㊴	Cylinder tube gasket	NBR	
㊵	Rod seal A	NBR	
㊶	Cushion seal	NBR	
㊷	Cushion valve seal	NBR	
㊸	Piston gasket	NBR	
㊹	Release piston seal	NBR	
㊺	Rod seal B	NBR	
㊻	Release piston gasket	NBR	
㊼	Piston guide gasket	NBR	
㊽	Unlocking cam gasket	NBR	

Replacement Parts: Seal Kit

Bore size (mm)	Kit no.	Contents
32	MB32Z-PS	A set of ㉙, ㉚, ㉛ and ㉜ above
40	MB1-40Z-PS	
50	MB1-50Z-PS	
63	MB1-63Z-PS	
80	MB1-80Z-PS	
100	MB1-100Z-PS	

* Since the lock section for the MNB series is normally replaced as a unit, kits are for the cylinder section only. These can be ordered using the order number for each bore size.

* Seal kit includes a grease pack (ø32 to ø50: 10 g, ø63 and ø80: 20 g, ø100: 30 g). Order with the following part number when only the grease pack is needed.
Grease pack part number: GR-S-010 (10 g), GR-S-020 (20 g)

MNB Series

Dimensions

Axial foot type (L): MNBL

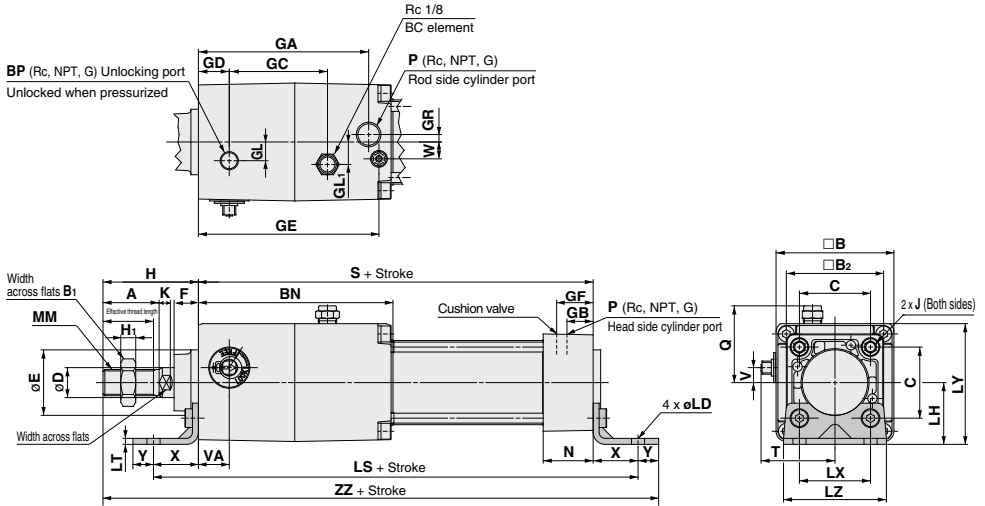

(mm)

Bore size (mm)	Stroke range (mm)	Effective thread length (mm)	Width across flats	A	B	B ₁	H ₁	B ₂	BN	BP	C	D	Ee ₁₁	F	GA	GB	GC	GD	GL	GL ₁	GR	GE	GF
32	Up to 700	19.5	10	22	54	17	6	46	97	1/8	32.5	12	30	13	83	13	45.5	13	8.5	12	4	88.5	18.3
40	Up to 800	27	14	30	63	22	8	52	104	1/8	38	16	35	13	91	14	52.5	16.5	10	12	4	96.5	19.5
50	Up to 1000	32	18	35	75	27	11	65	120.5	1/4	46.5	20	40	14	104.5	15.5	58.5	19	12.5	15	5	111.2	22.4
63	Up to 1000	32	18	35	90	27	11	75	134.5	1/4	56.5	20	45	14	119.5	16.5	68	23	17.5	12	9	123.5	20.7
80	Up to 1000	37	22	40	102	32	13	95	169	1/4	72	25	45	20	150	19	81	33	22	18	11.5	157	26
100	Up to 1000	37	26	40	116	41	16	114	189	1/4	89	30	55	20	170	19	96	37.5	25	20	17	177	26

Bore size (mm)	J	LD	LH	LS	LT	LX	LY	LZ	K	MM	N	P	Q	H	S	T	V	VA	W	X	Y	ZZ
32	M6 x 1.0	7	30	198	3.2	32	57	50	6	M10 x 1.25	27	1/8	37	47	154	34	6.5	13	6.5	22	9	232
40	M6 x 1.0	9	33	209	3.2	38	64.5	55	6	M14 x 1.5	27	1/4	41.5	51	161	39.5	8	16.5	9	24	11	247
50	M8 x 1.25	9	40	237	3.2	46	77.5	70	7	M18 x 1.5	31.5	1/4	47.5	58	183	47	9	20	10.5	27	11	279
63	M8 x 1.25	12	48	251	3.6	56	93	80	7	M18 x 1.5	31.5	3/8	55	58	197	55.5	8.5	23	12	27	14	296
80	M10 x 1.5	12	55	305	4.5	72	106	100	10	M22 x 1.5	38	3/8	61	72	245	61.5	10.5	33	14	30	14	361
100	M10 x 1.5	14	65	329	4.5	89	123	120	10	M26 x 1.5	38	1/2	68	72	265	69.5	10.5	37.5	15	32	16	385

* Refer to page 895 for cylinders with a rod boot.

Rod side flange type (F): MNB F

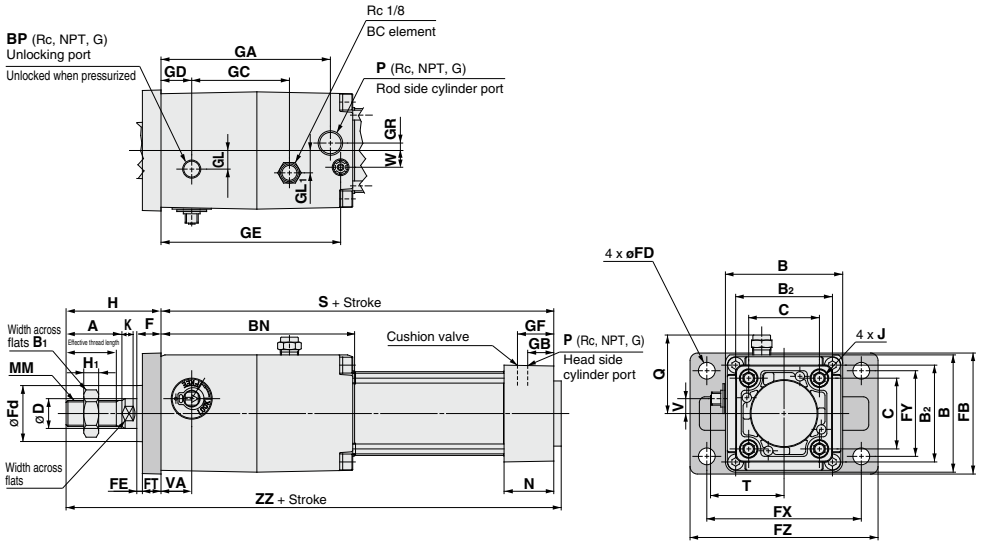

- CLJ2
- CLM2
- CLG1
- CL1
- MLGC
- CNG
- MNB**
- CNA2
- CNS
- CLS
- CLQ
- RLQ
- MLU
- MLGP
- ML1C

Bore size (mm)	Stroke range (mm)	Effective thread length (mm)	Width across flats	A	FB	B	B ₁	H ₁	B ₂	BN	BP	C	D	F	F _d	FD	FE	FT	FX	FY	FZ	GA	GB
32	Up to 700	19.5	10	22	56	54	17	6	46	97	1/8	32.5	12	13	25	7	3	10	72	38	87	83	13
40	Up to 800	27	14	30	65	63	22	8	52	104	1/8	38	16	13	31	9	3	10	83	46	101	91	14
50	Up to 1000	32	18	35	77	75	27	11	65	120.5	1/4	46.5	20	14	38.5	9	2	12	100	52	120	104.5	15.5
63	Up to 1000	32	18	35	92	90	27	11	75	134.5	1/4	56.5	20	14	39.5	9	2	12	115	62	135	119.5	16.5
80	Up to 1000	37	22	40	100	102	32	13	95	169	1/4	72	25	20	45.5	12	4	16	126	63	153	150	19
100	Up to 1000	37	26	40	120	116	41	16	114	189	1/4	89	30	20	54	14	4	16	150	75	178	170	19

Bore size (mm)	GC	GD	GL	GL ₁	GR	GE	GF	J	K	MM	N	P	Q	H	S	T	V	VA	W	ZZ
32	45.5	13	8.5	12	4	88.5	18.3	M6 x 1.0	6	M10 x 1.25	27	1/8	37	47	154	34	6.5	13	6.5	205
40	52.5	16.5	10	12	4	96.5	19.5	M6 x 1.0	6	M14 x 1.5	27	1/4	41.5	51	161	39.5	8	16.5	9	216
50	58.5	19	12.5	15	5	111.2	22.4	M8 x 1.25	7	M18 x 1.5	31.5	1/4	47.5	58	183	47	9	20	10.5	245
63	68	23	17.5	12	9	123.5	20.7	M8 x 1.25	7	M18 x 1.5	31.5	3/8	55	58	197	55.5	8.5	23	12	259
80	81	33	22	18	11.5	157	26	M10 x 1.5	10	M22 x 1.5	38	3/8	61	72	245	61.5	10.5	33	14	321
100	96	37.5	25	20	17	177	26	M10 x 1.5	10	M26 x 1.5	38	1/2	68	72	265	69.5	10.5	37.5	15	341

* Refer to page 895 for cylinders with a rod boot.

- D-□
- X□

MNB Series

Dimensions

Head side flange type (G): MNBG

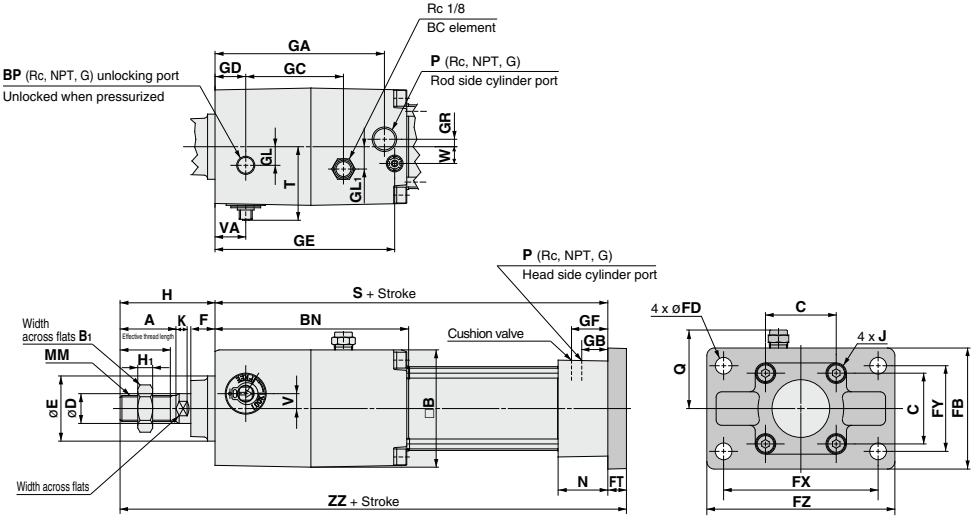

Bore size (mm)	Stroke range (mm)	Effective thread length (mm)	Width across flats	(mm)																			
				A	FB	B	B ₁	H ₁	BN	BP	C	D	Ee ₁₁	F	FD	FT	FX	FY	FZ	GA	GB	GC	GD
32	Up to 500	19.5	10	22	56	54	17	6	97	1/8	32.5	12	30	13	7	10	72	38	87	83	13	45.5	13
40	Up to 500	27	14	30	65	63	22	8	104	1/8	38	16	35	13	9	10	83	46	101	91	14	52.5	16.5
50	Up to 600	32	18	35	77	75	27	11	120.5	1/4	46.5	20	40	14	9	12	100	52	120	104.5	15.5	58.5	19
63	Up to 600	32	18	35	92	90	27	11	134.5	1/4	56.5	20	45	14	9	12	115	62	135	119.5	16.5	68	23
80	Up to 800	37	22	40	100	102	32	13	169	1/4	72	25	45	20	12	16	126	63	153	150	19	81	33
100	Up to 800	37	26	40	120	116	41	16	189	1/4	89	30	55	20	14	16	150	75	178	170	19	96	37.5

Bore size (mm)	GL	GL ₁	GR	GE	GF	J	K	MM	N	P	Q	H	S	T	V	VA	W	ZZ
32	8.5	12	4	88.5	18.3	M6 x 1.0	6	M10 x 1.25	27	1/8	37	47	154	34	6.5	13	6.5	211
40	10	12	4	96.5	19.5	M6 x 1.0	6	M14 x 1.5	27	1/4	41.5	51	161	39.5	8	16.5	9	222
50	12.5	15	5	111.2	22.4	M8 x 1.25	7	M18 x 1.5	31.5	1/4	47.5	58	183	47	9	20	10.5	253
63	17.5	12	9	123.5	20.7	M8 x 1.25	7	M18 x 1.5	31.5	3/8	55	58	197	55.5	8.5	23	12	267
80	22	18	11.5	157	26	M10 x 1.5	10	M22 x 1.5	38	3/8	61	72	245	61.5	10.5	33	14	333
100	25	20	17	177	26	M10 x 1.5	10	M26 x 1.5	38	1/2	68	72	265	69.5	10.5	37.5	15	353

* Refer to page 895 for cylinders with a rod boot.

Single clevis type (C): MNBC

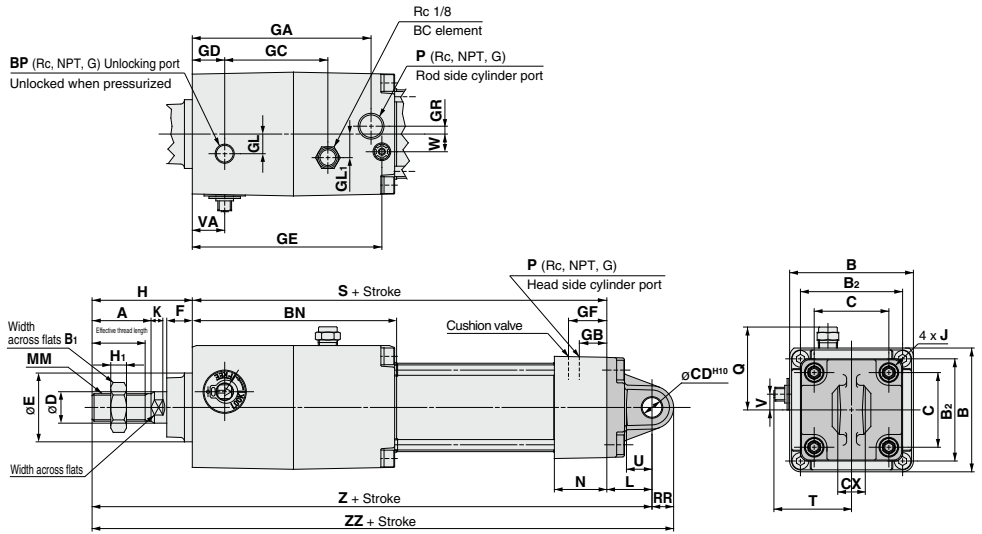

Bore size (mm)	Stroke range (mm)	Effective thread length (mm)	Width across flats	(mm)																			
				A	B	B ₁	H ₁	B ₂	BN	BP	C	CD ^{H10}	CX ^{-0.1/0.2}	D	Ee ₁₁	F	GA	GB	GC	GD	GL	GL ₁	GR
32	Up to 500	19.5	10	22	54	17	6	46	97	1/8	32.5	10	14	12	30	13	83	13	45.5	13	8.5	12	4
40	Up to 500	27	14	30	63	22	8	52	104	1/8	38	10	14	16	35	13	91	14	52.5	16.5	10	12	4
50	Up to 600	32	18	35	75	27	11	65	120.5	1/4	46.5	14	20	20	40	14	104.5	15.5	58.5	19	12.5	15	5
63	Up to 600	32	18	35	90	27	11	75	134.5	1/4	56.5	14	20	20	45	14	119.5	16.5	68	23	17.5	12	9
80	Up to 800	37	22	40	102	32	13	95	169	1/4	72	22	30	25	45	20	150	19	81	33	22	18	11.5
100	Up to 800	37	26	40	116	41	16	114	189	1/4	89	22	30	30	55	20	170	19	96	37.5	25	20	17

Bore size (mm)	GE	GF	J	K	L	MM	N	P	Q	RR	H	S	T	U	V	VA	W	Z	ZZ
32	88.5	18.3	M6 x 1.0	6	23	M10 x 1.25	27	1/8	37	10.5	47	154	34	13	6.5	13	6.5	224	234.5
40	96.5	19.5	M6 x 1.0	6	23	M14 x 1.5	27	1/4	41.5	11	51	161	39.5	13	8	16.5	9	235	246
50	111.2	22.4	M8 x 1.25	7	30	M18 x 1.5	31.5	1/4	47.5	15	58	183	47	17	9	20	10.5	271	286
63	123.5	20.7	M8 x 1.25	7	30	M18 x 1.5	31.5	3/8	55	15	58	197	55.5	17	8.5	23	12	285	300
80	157	26	M10 x 1.5	10	42	M22 x 1.5	38	3/8	61	23	72	245	61.5	26	10.5	33	14	359	382
100	177	26	M10 x 1.5	10	42	M26 x 1.5	38	1/2	68	23	72	265	69.5	26	10.5	37.5	15	379	402

* Refer to page 895 for cylinders with a rod boot.

- CLJ2
- CLM2
- CLG1
- CL1
- MLGC
- CNG
- MNB**
- CNA2
- CNS
- CLS
- CLQ
- RLQ
- MLU
- MLGP
- ML1C

- D-
- X

MNB Series

Dimensions

Double clevis type (D): MNBD

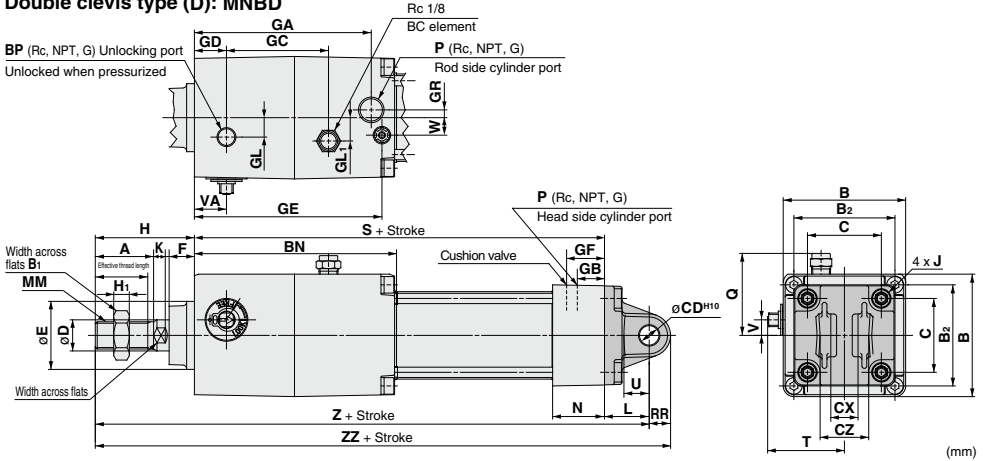

Bore size (mm)	Stroke range (mm)	Effective thread length (mm)	Width across flats	A	B	B ₁	H ₁	B ₂	BN	BP	C	Cp ^{H10}	CX ^{0.03/0.1}	CZ	D	Ee ₁₁	F	GA	GB	GC	GD	GL	GL ₁
32	Up to 500	19.5	10	22	54	17	6	46	97	1/8	32.5	10	14	28	12	30	13	83	13	45.5	13	8.5	12
40	Up to 500	27	14	30	63	22	8	52	104	1/8	38	10	14	28	16	35	13	91	14	52.5	16.5	10	12
50	Up to 600	32	18	35	75	27	11	65	120.5	1/4	46.5	14	20	40	20	40	14	104.5	15.5	58.5	19	12.5	15
63	Up to 600	32	18	35	90	27	11	75	134.5	1/4	56.5	14	20	40	20	45	14	119.5	16.5	68	23	17.5	12
80	Up to 800	37	22	40	102	32	13	95	169	1/4	72	22	30	60	25	45	20	150	19	81	33	22	18
100	Up to 800	37	26	40	116	41	16	114	189	1/4	89	22	30	60	30	55	20	170	19	96	37.5	25	20

Bore size (mm)	GR	GE	GF	J	K	L	MM	N	P	Q	RR	H	S	T	U	V	VA	W	Z	ZZ
32	4	88.5	18.3	M6 x 1.0	6	23	M10 x 1.25	27	1/8	37	10.5	47	154	34	13	6.5	13	6.5	224	234.5
40	4	96.5	19.5	M6 x 1.0	6	23	M14 x 1.5	27	1/4	41.5	11	51	161	39.5	13	8	16.5	9	235	246
50	5	111.2	22.4	M8 x 1.25	7	30	M18 x 1.5	31.5	1/4	47.5	15	58	183	47	17	9	20	10.5	271	286
63	9	123.5	20.7	M8 x 1.25	7	30	M18 x 1.5	31.5	3/8	55	15	58	197	55.5	17	8.5	23	12	285	300
80	11.5	157	26	M10 x 1.5	10	42	M22 x 1.5	38	3/8	61	23	72	245	61.5	26	10.5	33	14	359	382
100	17	177	26	M10 x 1.5	10	42	M26 x 1.5	38	1/2	68	23	72	265	69.5	26	10.5	37.5	15	379	402

* Refer to page 895 for cylinders with a rod boot.

Double Clevis Pivot Bracket

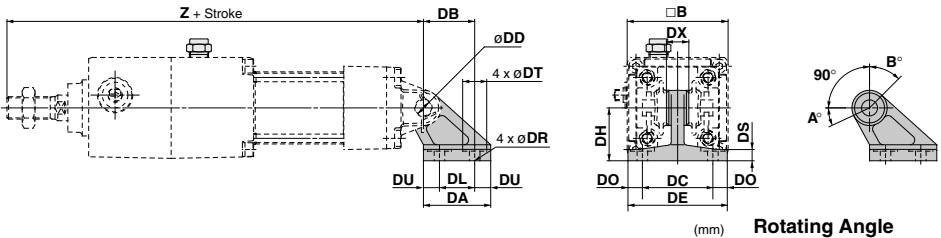

Part no.	Bore size (mm)	B	DA	DB	DL	DU	DC	DX	DE	DO	DR	DT	DS	DH	Z	DD _{H10} (Hole)
MB-B03	32	54	42	32	22	10	44	14	62	9	6.6	15	7	33	224	10 ^{+0.058/0}
	40	63	42	32	22	10	44	14	62	9	6.6	15	7	33	235	10 ^{+0.058/0}
MB-B05	50	75	53	43	30	11.5	60	20	81	10.5	9	18	8	45	271	14 ^{+0.070/0}
	63	90	53	43	30	11.5	60	20	81	10.5	9	18	8	45	285	14 ^{+0.070/0}
MB-B08	80	102	73	64	45	14	86	30	111	12.5	11	22	10	65	359	22 ^{+0.084/0}
	100	116	73	64	45	14	86	30	111	12.5	11	22	10	65	379	22 ^{+0.084/0}

Rotating Angle

Bore size (mm)	A°	B°	A° + B° + 90°
32, 40	25°	45°	160°
50, 63	40°	60°	190°
80, 100	30°	55°	175°

MNB Series

Accessory Bracket Dimensions

Accessory Bracket Dimensions

Rod End Nut
(Standard equipment)

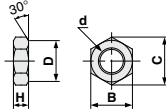

Part no.	Bore size (mm)	B	C	D	H	d
NT-03	32	17	19.6	16.5	6	M10 x 1.25
NT-04	40	22	25.4	21	8	M14 x 1.5
NT-05	50, 63	27	31.2	26	11	M18 x 1.5
NT-08	80	32	37.0	31	13	M22 x 1.5
NT-10	100	41	47.3	39	16	M26 x 1.5

I Type Single Knuckle Joint

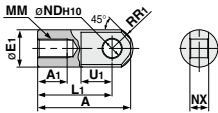

Part no.	Bore size (mm)	A	A ₁	E ₁	L ₁	MM	R ₁	U ₁	NDH ₁₀	NX
I-03M	32	40	14	20	30	M10 x 1.25	12	16	10 ^{+0.058} ₀	14 ^{+0.10} _{-0.30}
I-04M	40	50	19	22	40	M14 x 1.5	12.5	19	10 ^{+0.058} ₀	14 ^{+0.10} _{-0.30}
I-05M	50, 63	64	24	28	50	M18 x 1.5	16.5	24	14 ^{+0.070} ₀	20 ^{+0.10} _{-0.30}
I-08M	80	80	26	40	60	M22 x 1.5	23.5	34	22 ^{+0.084} ₀	30 ^{+0.10} _{-0.30}
I-10M	100	80	26	40	60	M26 x 1.5	23.5	34	22 ^{+0.084} ₀	30 ^{+0.10} _{-0.30}

Knuckle Joint Pin,
Clevis Pin

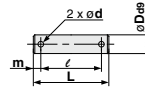

Part no.	Bore size (mm)		D _{ø8}	L	ℓ	m	d (Drill through)	Cotter pin (Note)
	Clevis	Knuckle						
CD-M03	32, 40	10 ^{-0.040} _{-0.076}	44	36	4	3	ø3 x 18 ℓ	
CD-M05	50, 63	14 ^{-0.060} _{-0.093}	60	51	4.5	4	ø4 x 25 ℓ	
CD-M08	80, 100	22 ^{-0.095} _{-0.117}	82	72	5	4	ø4 x 35 ℓ	

Note) Cotter pins and flat washers are included.

Y Type Double Knuckle Joint

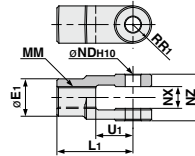

Part no.	Bore size (mm)	E ₁	L ₁	MM	R ₁	U ₁	NDH ₁₀	NX	NZ
Y-03M	32	20	30	M10 x 1.25	10	16	10 ^{+0.058} ₀	14 ^{+0.30} _{-0.10}	28 ^{+0.10} _{-0.30}
Y-04M	40	22	40	M14 x 1.5	11	19	10 ^{+0.058} ₀	14 ^{+0.30} _{-0.10}	28 ^{+0.10} _{-0.30}
Y-05M	50, 63	28	50	M18 x 1.5	14	24	14 ^{+0.070} ₀	20 ^{+0.30} _{-0.10}	40 ^{+0.10} _{-0.30}
Y-08M	80	40	65	M22 x 1.5	20	34	22 ^{+0.084} ₀	30 ^{+0.30} _{-0.10}	60 ^{+0.10} _{-0.30}
Y-10M	100	40	65	M26 x 1.5	20	34	22 ^{+0.084} ₀	30 ^{+0.30} _{-0.10}	60 ^{+0.10} _{-0.30}

Note) Pin, cotter pin and plain washer are attached with double knuckle joint.

CLJ2

CLM2

CLG1

CL1

MLGC

CNG

MNB

CNA2

CNS

CLS

CLQ

RLQ

MLU

MLGP

ML1C

D-□

-X□

Cylinder with Lock

Double Acting, Double Rod

MNBW Series

ø32, ø40, ø50, ø63, ø80, ø100

How to Order

MNBW L 50 - 100 - D

With auto switch **MDNBW L 50 - 100 - D - M9BW**

Mounting type

B	Basic type
L	Axial foot type
F	Rod side flange type

Bore size

32	32 mm
40	40 mm
50	50 mm
63	63 mm
80	80 mm
100	100 mm

Port thread type

Nil	Rc
TN	NPT
TF	G

Cylinder stroke (mm)

Refer to page 903 for the standard stroke.

Locking direction

D Both directions

Number of auto switches

Nil	2 pcs.
S	1 pc.
n	"n" pcs.

Auto switch

Nil	Without auto switch
-----	---------------------

* For the applicable auto switch model, refer to the table below.

Built-in Magnet Cylinder Model

If a built-in magnet cylinder without an auto switch is required, there is no need to enter the symbol for the auto switch. (Example) MDNBWL40-100-D

With rod boot

Rod boot	Nil	None
	J	Nylon tarpaulin
	K	Heat resistant tarpaulin

* Rod boot comes with both sides. If only single-sided is required, please consult with SMC.

Applicable Auto Switches

Refer to pages 1119 to 1245 for further information on auto switches.

Type	Special function	Electrical entry	Indicator light	Wiring (Output)	Load voltage			Auto switch model		Lead wire length (m)				Pre-wired connector	Applicable load					
					DC	AC		Tie-rod mounting	Band mounting	0.5 (Nil)	1 (M)	3 (L)	5 (Z)							
Solid state auto switch	—	Grommet	Yes	3-wire (NPN)	24 V	5 V, 12 V	—	M9N	—	●	●	○	○	IC circuit	Relay, PLC					
				3-wire (PNP)				M9P	—	●	●	○	○							
				2-wire				M9B	—	●	●	○	○							
		Terminal conduit		3-wire (NPN)				—	G39	—	—	—	—			—	—	—	—	—
				2-wire				—	K39	—	—	—	—			—	—	—	—	
				3-wire (NPN)				M9NW	—	●	●	○	○			IC circuit				
	3-wire (PNP)	M9PW	—	●	●	○	○	IC circuit												
	2-wire	M9BW	—	●	●	○	○													
	Diagnostic indication (2-color indicator)	Grommet	Yes	3-wire (NPN)	24 V	5 V, 12 V	—		M9NA*1	—	○	○	●	○		IC circuit				
				3-wire (PNP)				M9PA*1	—	○	○	●	○							
				2-wire				M9BA*1	—	○	○	●	○							
		Water resistant (2-color indicator)		4-wire (NPN)				F59F	—	●	—	●	○	IC circuit						
2-wire (Non-polar)				P3DWA				—	●	—	●	○								
—				P4DW				—	—	—	—	—	—							
Reed auto switch	—	Grommet	Yes	3-wire (NPN equivalent)	24 V	5 V	—	A96	—	●	—	●	—	IC circuit	Relay, PLC					
				Terminal conduit				100 V	A93	—	●	●	●			—	IC circuit			
								100 V or less	A90	—	●	—	●			—				
								100 V, 200 V	A54	—	●	—	●			—				
								200 V or less	A64	—	●	—	●			—				
				DIN terminal				—	A33	—	—	—	—			—	—			
		—						A34	—	—	—	—	—							
		—						A44	—	—	—	—	—							
		100 V, 200 V						—	—	—	—	—	—							
		—						A59W	—	●	—	●	—	IC circuit						
		—						—	—	—	—	—	—							

*1 Water resistant type auto switches can be mounted on the above models, but in such case SMC cannot guarantee water resistance. Consult with SMC regarding water resistant types with the above model numbers.

* Lead wire length symbols: 0.5 m.....Nil (Example) M9NW
 1 m.....M (Example) M9NWM
 3 m.....L (Example) M9NWL
 5 m.....Z (Example) M9NWZ

* Solid state auto switches marked with "○" are produced upon receipt of order.

* Since there are other applicable auto switches than listed, refer to page 911 for details.

* D-A9□/M9□/P3DWA□ auto switches are shipped together (not assembled). (Only auto switch brackets are assembled at the time of shipment for D-A9□ and M9□.)



Cylinder Specifications

Bore size (mm)	32	40	50	63	80	100
Lubrication	Not required (Non-lube)					
Fluid	Air					
Proof pressure	1.5 MPa					
Max. operating pressure	1.0 MPa					
Min. operating pressure	0.08 MPa					
Piston speed	50 to 1000 mm/s*					
Ambient and fluid temperature	Without auto switch: -10 to 70°C (No freezing) With auto switch: -10 to 60°C (No freezing)					
Cushion	Air cushion on both ends					
Stroke length tolerance	Up to 250: $^{+10}_0$, 251 to 1000: $^{+14}_0$					
Mounting	Basic type, Axial foot type, Rod side flange type					

* Load limits exist depending upon piston speed when locked, mounting direction and operating pressure.

Lock Specifications

Bore size (mm)	32	40	50	63	80	100
Locking action	Spring locking (Exhaust locking)					
Unlocking pressure	0.25 MPa or more					
Lock starting pressure	0.20 MPa or less					
Max. operating pressure	1.0 MPa					
Locking direction	Both directions					
Holding force (maximum static load) N*	552	882	1370	2160	3430	5390

* The holding force (max. static load) shows the maximum capability and does not show the normal holding capability. So, select an appropriate cylinder while referring to page 888.

For cases with auto switches, refer to the table of minimum strokes for /mounting of auto switches (page 910).

Bore size (mm)	Standard stroke (mm)
32	25, 50, 75, 100, 125, 150, 175, 200, 250, 300, 350, 400, 450, 500
40	25, 50, 75, 100, 125, 150, 175, 200, 250, 300, 350, 400, 450, 500
50	25, 50, 75, 100, 125, 150, 175, 200, 250, 300, 350, 400, 450, 500, 600
63	25, 50, 75, 100, 125, 150, 175, 200, 250, 300, 350, 400, 450, 500, 600
80	25, 50, 75, 100, 125, 150, 175, 200, 250, 300, 350, 400, 450, 500, 600, 700, 800
100	25, 50, 75, 100, 125, 150, 175, 200, 250, 300, 350, 400, 450, 500, 600, 700, 800

* Intermediate strokes other than the above are produced upon receipt of order. Spacers are not used for intermediate strokes.

Stopping Accuracy

Lock type	Piston speed (mm/s)			
	100	300	500	1000
Spring locking	±0.3	±0.6	±1.0	±2.0

Condition: Lateral, Supply pressure P = 0.5 MPa
Load mass Upper limit of allowed value
Solenoid valve for locking mounted on the unlocking port
Maximum value of stopping position dispersion from 100 measurements

Refer to pages 908 to 911 for cylinders with auto switches.

- Minimum auto switch mounting stroke
- Proper auto switch mounting position (detection at stroke end) and mounting height
- Operating range
- Auto switch mounting bracket: Part no.

CLJ2
CLM2
CLG1
CL1
MLGC
CNG
MNB
CNA2
CNS
CLS
CLQ
RLQ
MLU
MLGP
ML1C

D-□
-X□

MNBW Series

Mounting Bracket Part No.

Bore size (mm)	32	40	50	63	80	100
Foot (1)	MB-L03	MB-L04	MB-L05	MNB-L*	MB-L08	MB-L10
Flange	MNB-F03*	MNB-F04*	MNB-F05*	MNB-F06*	MB-F08	MB-F10

Note 1) When ordering foot bracket, order 2 pieces per cylinder.

Note 2) Accessories for each mounting bracket are as follows.

Foot, Flange: Body mounting bolts

Note 3) All are common to the MB series air cylinders, except the sections marked with a *.

Rod Boot Material

Symbol	Rod boot material	Max. ambient temperature
J	Nylon tarpaulin	70°C
K	Heat resistant tarpaulin	110°C *

* Maximum ambient temperature for the rod boot itself.

Accessory

Mounting		Basic type	Foot type	Rod side flange type
Standard equipment	Rod end nut	●	●	●
Option	With rod boot	●	●	●

Double Rod Weight/Aluminum Tube

Bore size (mm)		32	40	50	63	80	100		
Basic weight	Basic type	1.26	1.82	2.91	4.24	7.23	10.70		
	Foot type	1.36	1.94	3.09	4.50	7.66	11.29		
	Flange type	1.50	2.14	3.44	4.98	8.68	14.01		
Additional weight per each 50 mm of stroke		All mounting brackets		0.15	0.24	0.34	0.35	0.61	0.84
Accessory	Single knuckle		0.15	0.23	0.26	0.26	0.60	0.83	
	Double knuckle (With pin)		0.22	0.37	0.43	0.43	0.87	1.27	

Calculation:

(Example) **MNBWB32-100-D** (Basic type, ø32, 100 st)

• Basic weight 1.26 (Basic type, ø32)

• Additional weight 0.11/50 stroke

• Cylinder stroke 100 stroke

$$1.26 + 0.11 \times 100/50 = 1.48 \text{ kg}$$

Construction

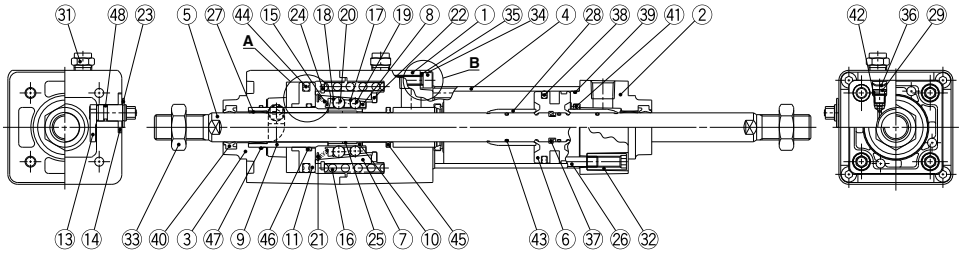

A section

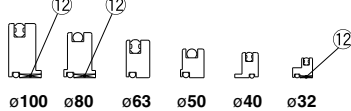

B section

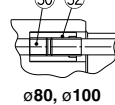

Component Parts

No.	Description	Material	Note
1	Rod cover A	Aluminum alloy	Hard anodized and metallic painted
2	Rod cover B	Aluminum die-casted	Chromated and metallic painted
3	Cover	Aluminum alloy	Hard anodized and metallic painted
4	Cylinder tube	Aluminum alloy	Hard anodized
5	Piston rod	Carbon steel	Hard chrome plated
6	Piston	Aluminum alloy	Chromated
7	Taper ring	Carbon steel	Heat treated
8	Ball retainer	Special resin	
9	Piston guide	Carbon steel	Zinc chromated
10	Brake shoe holder	Special steel	Heat treated
11	Release piston	Aluminum alloy	Chromated
	ø32, ø80, ø100 ø40, ø50, ø63		Hard anodized
12	Release piston bushing	Steel + Special resin	ø32, ø80, ø100 only
13	Unlocking cam	Chromium molybdenum steel	Glossy chromated
14	Washer	Carbon steel	Colorless zinc chromated
15	Retainer pre-load spring	ø32	Steel wire Zinc chromated
		ø40 to ø100	Stainless steel wire
16	Brake spring	Steel wire	Zinc chromated
17	Clip A	Stainless steel	
18	Clip B	Stainless steel	
19	Steel ball A	Carbon steel	
20	Steel ball B	Carbon steel	
21	Tooth ring	Stainless steel	
22	Bumper	Polyurethane rubber	
23	Type C retaining ring for unlocking cam shaft	Carbon steel	
24	Type C retaining ring for taper ring	Carbon steel	
25	Brake shoe	Babbitt	
26	Tie-rod	Carbon steel	Zinc chromated
27	Bushing	Bearing alloy	
28	Cushion ring	Aluminum alloy	Anodized

Component Parts

No.	Description	Material	Note
29	Cushion valve	Steel wire	
30	Unit holding tie-rod	Carbon steel	ø80, ø100 only
31	BC element		
32	Tie-rod nut	Carbon steel	
33	Rod end nut	Carbon steel	
34	Hexagon socket head cap screw	Chromium molybdenum steel	ø32 to ø63
35	Spring washer for hex. socket head cap screw	Steel wire	ø32 to ø63
36	Retaining ring	Spring steel	
37	Piston holder	Urethane	
38	Piston seal	NBR	
39	Cylinder tube gasket	NBR	
40	Rod seal A	NBR	
41	Cushion seal	NBR	
42	Cushion valve seal	NBR	
43	Piston gasket	NBR	
44	Release piston seal	NBR	
45	Rod seal B	NBR	
46	Release piston gasket	NBR	
47	Piston guide gasket	NBR	
48	Unlocking cam gasket	NBR	

Replacement Parts: Seal Kit

Bore size (mm)	Kit no.	Contents
32	MBW32-PS	A set of 39, 39, 40 and 41 above
40	MBW40-PS	
50	MBW50-PS	
63	MBW63-PS	
80	MBW80-PS	
100	MBW100-PS	

* As a general rule, the lock section of the MNBW series is replaced as a unit, and therefore, the replacement seal kits are for the cylinder section only. These can be ordered using the order number for each bore size.

* Seal kit includes a grease pack (ø32 to ø50: 10 g, ø63 and ø80: 20 g, ø100: 30 g). Order with the following part number when only the grease pack is needed.
Grease pack part number: GR-S-010 (10 g), GR-S-020 (20 g)

CLJ2

CLM2

CLG1

CL1

MLGC

CNG

MNB

CNA2

CNS

CLS

CLQ

RLQ

MLU

MLGP

ML1C

D-□

-X□

Dimensions

Axial foot type (L):

MNBWL

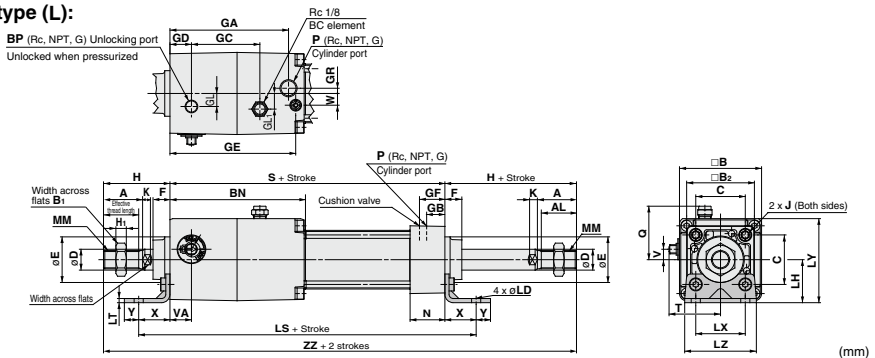

Bore size (mm)	Stroke range (mm)	Effective thread length (mm)	Width across flats	A	B	B1	H1	B2	BN	BP	C	D	Ee11	F	GA	GB	GC	GD	GL	GL1	GR	GE	GF
32	Up to 500	19.5	10	22	54	17	6	46	97	1/8	32.5	12	30	13	83	13	45.5	13	8.5	12	4	88.5	18.3
40	Up to 500	27	14	30	63	22	8	52	104	1/8	38	16	35	13	91	14	52.5	16.5	10	12	4	96.5	19.5
50	Up to 600	32	18	35	75	27	11	65	120.5	1/4	46.5	20	40	14	104.5	15.5	58.5	19	12.5	15	5	111.2	22.4
63	Up to 600	32	18	35	90	27	11	75	134.5	1/4	56.5	20	45	14	119.5	16.5	68	23	17.5	12	9	123.5	20.7
80	Up to 800	37	22	40	102	32	13	95	169	1/4	72	25	45	20	150	19	81	33	22	18	11.5	157	26
100	Up to 800	37	26	40	116	41	16	114	189	1/4	89	30	55	20	170	19	96	37.5	25	20	17	177	26

Bore size (mm)	J	LD	LH	LS	LT	LX	LY	LZ	K	MM	N	P	Q	H	S	T	V	VA	W	X	Y	ZZ
32	M6 x 1.0	7	30	198	3.2	32	57	50	6	M10 x 1.25	27	1/8	37	47	154	34	6.5	13	6.5	22	9	248
40	M6 x 1.0	9	33	209	3.2	38	64.5	55	6	M14 x 1.5	27	1/4	41.5	51	161	39.5	8	16.5	9	24	11	263
50	M8 x 1.25	9	40	237	3.2	46	77.5	70	7	M18 x 1.5	31.5	1/4	47.5	58	183	47	9	20	10.5	27	11	299
63	M8 x 1.25	12	48	251	3.6	56	93	80	7	M18 x 1.5	31.5	3/8	55	58	197	55.5	8.5	23	12	27	14	313
80	M10 x 1.5	12	55	305	4.5	72	106	100	10	M22 x 1.5	38	3/8	61	72	245	61.5	10.5	33	14	30	14	389
100	M10 x 1.5	14	65	329	4.5	89	123	120	10	M26 x 1.5	38	1/2	68	72	265	69.5	10.5	37.5	15	32	16	409

* Refer to page 906 for cylinders with a rod boot.

Rod side flange type (F):

MNBWF

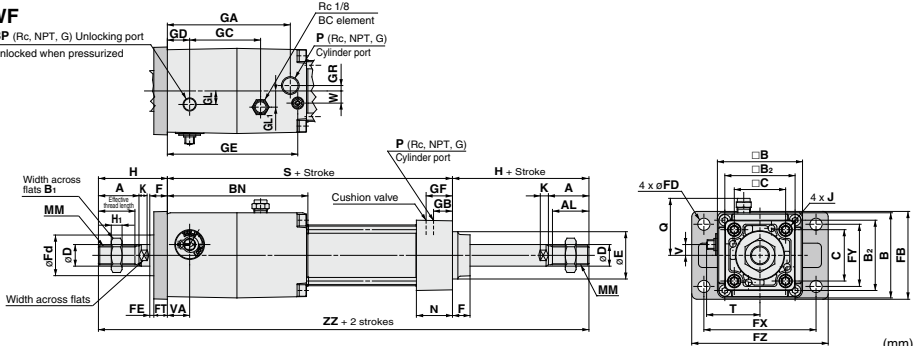

Bore size (mm)	Stroke range (mm)	Effective thread length (mm)	Width across flats	A	FB	B	B1	H1	B2	BN	BP	C	D	Ee11	F	Fd	FD	FE	FT	FX	FY	FZ
32	Up to 500	19.5	10	22	56	54	17	6	46	97	1/8	32.5	12	30	13	25	7	3	10	72	38	87
40	Up to 500	27	14	30	65	63	22	8	52	104	1/8	38	16	35	13	31	9	3	10	83	46	101
50	Up to 600	32	18	35	77	75	27	11	65	120.5	1/4	46.5	20	40	14	38.5	9	2	12	100	52	120
63	Up to 600	32	18	35	92	90	27	11	75	134.5	1/4	56.5	20	45	14	39.5	9	2	12	115	62	135
80	Up to 800	37	22	40	100	102	32	13	95	169	1/4	72	25	45	20	45.5	12	4	16	126	63	153
100	Up to 800	37	26	40	120	116	41	16	114	189	1/4	89	30	55	20	54	14	4	16	150	75	178

Bore size (mm)	GA	GB	GC	GD	GL	GL1	GR	GE	GF	J	K	MM	N	P	Q	H	S	T	V	VA	W	ZZ
32	83	13	45.5	13	8.5	12	4	88.5	18.3	M6 x 1.0	6	M10 x 1.25	27	1/8	37	47	154	34	6.5	13	6.5	248
40	91	14	52.5	16.5	10	12	4	96.5	19.5	M6 x 1.0	6	M14 x 1.5	27	1/4	41.5	51	161	39.5	8	16.5	9	263
50	104.5	15.5	58.5	19	12.5	15	5	111.2	22.4	M8 x 1.25	7	M18 x 1.5	31.5	1/4	47.5	58	183	47	9	20	10.5	299
63	119.5	16.5	68	23	17.5	12	9	123.5	20.7	M8 x 1.25	7	M18 x 1.5	31.5	3/8	55	58	197	55.5	8.5	23	12	313
80	150	19	81	33	22	18	11.5	157	26	M10 x 1.5	10	M22 x 1.5	38	3/8	61	72	245	61.5	10.5	33	14	389
100	170	19	96	37.5	25	20	17	177	26	M10 x 1.5	10	M26 x 1.5	38	1/2	68	72	265	69.5	10.5	37.5	15	409

* Refer to page 906 for cylinders with a rod boot.

- CLJ2
- CLM2
- CLG1
- CL1
- MLGC
- CNG
- MNB
- CNA2
- CNS
- CLS
- CLQ
- RLQ
- MLU
- MLGP
- ML1C

- D-□
- X□

Auto Switch Mounting 1

Auto Switch Proper Mounting Position (Detection at Stroke End) and Its Mounting Height

<Band mounting type>

D-A3□/G39/K39

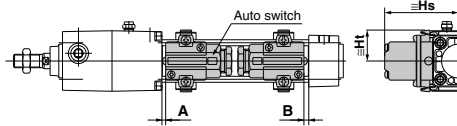

D-A44

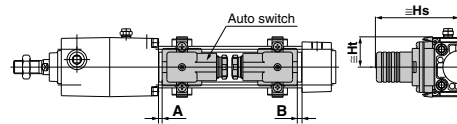

<Tie-rod mounting type>

D-M9□/M9□V

D-M9□W/M9□WV

D-M9□A/M9□AV

D-A9□/A9□V

D-Z7□/Z80

D-Y59/Y69/Y7P/Y7PV

D-Y7□W/Y7□WV/Y7BA

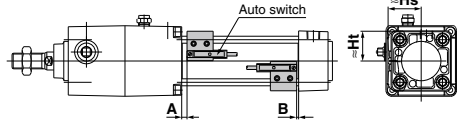

D-A5□/A6□

D-A59W

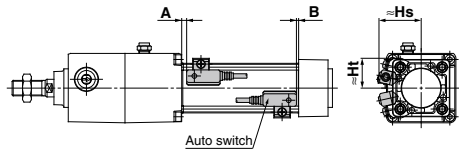

D-F5□/J59

D-F5□W/J59W/F5BA

D-F59F/F5NT

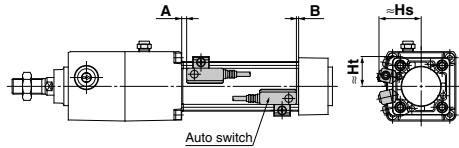

D-P3DWA

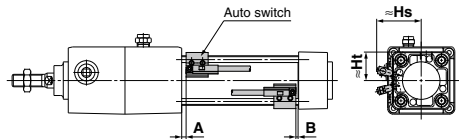

D-P4DW

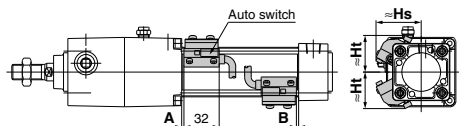

Auto Switch Proper Mounting Position (Detection at Stroke End) and Mounting Height

Auto Switch Proper Mounting Position (mm)

Auto switch model	D-M9□ D-M9□V D-M9□W D-M9□WV D-M9□A D-M9□AV		D-A9□ D-A9□V		D-A5□ D-A6□		D-A59W		D-F5□W D-J59W D-F5□ D-J59 D-F5BA D-F59F		D-F5NT		D-A3□ D-A44 D-G39 D-K39		D-Z7□ D-Z80 D-Y59□ D-Y69□ D-Y7P D-Y7PV D-Y7□WV D-Y7□WV D-Y7BA		D-P3DWA		D-P4DW	
	A	B	A	B	A	B	A	B	A	B	A	B	A	B	A	B	A	B	A	B
32	10.5	8	6.5	4	0.5	0	4.5	2	7	4.5	12	9.5	0.5	0	4	1.5	6	3	3.5	1
40	10.5	8	6.5	4	0.5	0	4.5	2	7	4.5	12	9.5	0.5	0	4	1.5	6	3.5	3.5	1
50	11	8.5	7	4.5	1	0	5	2.5	7.5	5	12.5	10	1	0	4.5	2	6.5	4	4	1.5
63	11	8.5	7	4.5	1	0	5	2.5	7.5	5	12.5	10	1	0	4.5	2	6.5	4	4	1.5
80	14	12.5	10	8.5	4	2.5	8	6.5	10.5	9	15.5	14	4	2.5	7.5	6	9.5	8	7	5.5
100	14	12.5	10	8.5	4	2.5	8	6.5	10.5	9	15.5	14	4	2.5	7.5	6	9.5	8	7	5.5

Note) Adjust the auto switch after confirming the operating conditions in the actual setting.

Auto Switch Mounting Height (mm)

Auto switch model	D-M9□ D-M9□V D-M9□W D-M9□A D-A9□		D-M9□V D-M9□WV D-M9□AV		D-A9□V		D-A5□ D-A6□ D-A59W		D-F5□ D-J59 D-F59F D-F5□W D-J59W D-F5BA D-F5NT		D-A3□ D-G39 D-K39		D-A44		D-Z7□ D-Z80 D-Y59□ D-Y7P D-Y7PV D-Y7□W D-Y7BA		D-Y69□ D-Y7PV D-Y7□WV		D-P3DWA		D-P4DW	
	Hs	Ht	Hs	Ht	Hs	Ht	Hs	Ht	Hs	Ht	Hs	Ht	Hs	Ht	Hs	Ht	Hs	Ht	Hs	Ht	Hs	Ht
32	24.5	23	30.5	23	27.5	23	35	24.5	32.5	25	67	27.5	77	27.5	25.5	23	26.5	23	38	31	38	31
40	28.5	25.5	34	25.5	31.5	25.5	38.5	27.5	36.5	27.5	71.5	27.5	81.5	27.5	29.5	26	30	26	39	25.5	42	33
50	33.5	31	38.5	31	36	31	43.5	34.5	41	34	77	—	87	—	33.5	31	34.5	31	43	31	46.5	39
63	38.5	36	43	36	40.5	36	48.5	39.5	46	39	83.5	—	93.5	—	39	36	40	36	48	36	51.5	44
80	46.5	45	52	45	49	45	55	46.5	52.5	46.5	92.5	—	103	—	47.5	45	48.5	45	56.5	45	58	51.5
100	54	53.5	59.5	53.5	57	53.5	62	55	59.5	55	103	—	113.5	—	55.5	53.5	56.5	53.5	64.5	53.5	65.5	60.5

Operating Range (mm)

Auto switch model	Bore size (mm)					
	32	40	50	63	80	100
D-M9□/M9□V D-M9□W/M9□WV D-M9□A/M9□AV	4	4.5	5	6	6	6
D-A9□/A9□V	7	7.5	8.5	9.5	9.5	10.5
D-Z7□/Z80	7.5	8.5	7.5	9.5	9.5	10.5
D-A5□/A6□	9	9	10	11	11	11
D-A59W	13	13	13	14	14	15
D-A3□/A44	9	9	10	11	11	11
D-Y59□/Y69□ D-Y7P/Y7□V D-Y7□W/Y7□WV D-Y7BA	5.5	5.5	7	7.5	6.5	5.5
D-F5□/J59 D-F5□W/J59W D-F5BA/F5NT D-F59F	3.5	4	4	4.5	4.5	4.5
D-G39/K39	9	9	10	11	11	11
D-P3DWA	3	4.5	4.5	5	5	5.5
D-P4DW	4	4	4	4.5	4	4.5

* Since this is a guideline including hysteresis, not meant to be guaranteed.
(Assuming approximately ±30% dispersion.)
There may be the case it will vary substantially depending on an ambient environment.

- CLJ2
- CLM2
- CLG1
- CL1
- MLGC
- CNG
- MNB
- CNA2
- CNS
- CLS
- CLQ
- RLQ
- MLU
- MLGP
- ML1C

- D-□
- X□

Auto Switch Mounting 2

Minimum Stroke for Auto Switch Mounting

Auto switch model	No. of auto switches mounted	ø32, ø40, ø50, ø63, ø80, ø100
D-M9□ D-M9□W D-M9□A	2 (Different surfaces, same surface), 1	15
	n	$15 + 40 \frac{(n-2)}{2}$ (n=2, 4, 6, 8... Note)
D-M9□VV D-M9□WV D-M9□AV	2 (Different surfaces, same surface), 1	10
	n	$10 + 30 \frac{(n-2)}{2}$ (n=2, 4, 6, 8... Note)
D-A9□	2 (Different surfaces, same surface), 1	15
	n	$15 + 40 \frac{(n-2)}{2}$ (n = 2, 4, 6, 8... Note)
D-A9□V	2 (Different surfaces, same surface), 1	10
	n	$10 + 30 \frac{(n-2)}{2}$ (n=2, 4, 6, 8... Note)
D-A3□ D-G39 D-K39	2 (Different surfaces)	35
	2 (Same surface)	100
	n (Different surfaces)	$35 + 30 (n-2)$ (n = 2, 3, 4...)
	n (Same surface)	$100 + 100 (n-2)$ (n = 2, 3, 4...)
D-A44	1	10
	2 (Different surfaces)	35
	2 (Same surface)	55
	n (Different surfaces)	$35 + 30 (n-2)$ (n = 2, 3, 4...)
	n (Same surface)	$55 + 50 (n-2)$ (n = 2, 3, 4...)
1	10	

Note) When "n" is an odd number, an even number that is one larger than this odd number is used for the calculation.

n: No. of auto switches (mm)

Auto switch model	No. of auto switches mounted	ø32, ø40, ø50, ø63	ø80, ø100
D-A5□ D-A6□	2 (Different surfaces, same surface), 1	15	20
	n (Same surface)	$15 + 55 \frac{(n-2)}{2}$ (n=2, 4, 6, 8... Note)	$20 + 55 \frac{(n-2)}{2}$ (n=2, 4, 6, 8... Note)
D-A59W	2 (Different surfaces, same surface)	20	25
	n (Same surface)	$20 + 55 \frac{(n-2)}{2}$ (n=2, 4, 6, 8... Note)	$25 + 55 \frac{(n-2)}{2}$ (n=2, 4, 6, 8... Note)
	1	15	25
D-F5□/J59 D-F5□W D-J59W D-F5BA D-F59F D-F5NT	2 (Different surfaces, same surface)	15	25
	n (Same surface)	$15 + 55 \frac{(n-2)}{2}$ (n=2, 4, 6, 8... Note)	$25 + 55 \frac{(n-2)}{2}$ (n=2, 4, 6, 8... Note)
	1	10	25
	1	10	25
D-Z7□ D-Z80 D-Y59□ D-Y7P D-Y7□W	2 (Different surfaces, same surface), 1	15	
	n	$15 + 40 \frac{(n-2)}{2}$ (n=2, 4, 6, 8... Note)	
	1	10	
D-Y69□ D-Y7PV D-Y7□WV	2 (Different surfaces, same surface), 1	10	
	n	$10 + 30 \frac{(n-2)}{2}$ (n=2, 4, 6, 8... Note)	
D-Y7BA	2 (Different surfaces, same surface), 1	20	
	n	$20 + 45 \frac{(n-2)}{2}$ (n=2, 4, 6, 8... Note)	
D-P3DWA	2 (Different surfaces, same surface), 1	15	
	n	$15 + 50 \frac{(n-2)}{2}$ (n=2, 4, 6, 8... Note)	
D-P4DW	2 (Different surfaces, same surface), 1	15	
	n	$15 + 65 \frac{(n-2)}{2}$ (n=2, 4, 6, 8... Note)	

Auto Switch Mounting Bracket Part No.

Auto switch model	Bore size (mm)					
	ø32	ø40	ø50	ø63	ø80	ø100
D-M9□/M9□V D-M9□W/M9□WV D-M9□A/M9□AV D-A9□/A9□V	BMB5-032	BMB5-032	BA7-040	BA7-040	BA7-063	BA7-063
D-A3□/A44 D-G39/K39	BMB2-032	BMB2-040	BMB1-050	BMB1-063	BMB1-080	BMB1-100
D-A5□/A6□ D-A59W D-F5□/J59 D-F5□W/J59W D-F5□F D-F5BA D-F5NT	BT-03	BT-03	BT-05	BT-05	BT-06	BT-06
D-P3DWA	BA10-032S	BA10-040S	BA10-050S	BA10-050S	BA10-063S	BA10-063S
D-P4DW	BMB3T-040	BMB3T-040	BMB3T-050	BMB3T-050	BMB3T-080	BMB3T-080
D-Z7□/Z80 D-Y59□/Y69□ D-Y7P/Y7PV D-Y7□W D-Y7□WV D-Y7BA	BMB4-032	BMB4-032	BMB4-050	BMB4-050	BA4-063	BA4-063

* The above figure shows the mounting example of D-A9□(V)/M9□(V)/M9□W(V)/M9□A(V).

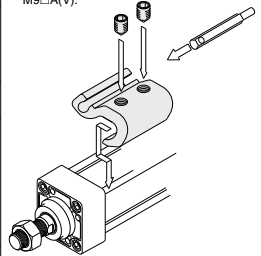

-Mounting example for ø32, D-P3DWA-

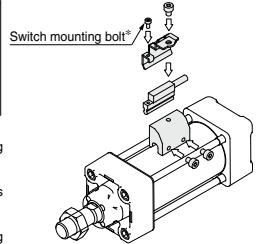

* The switch mounting bolt is supplied with the switch.

[Mounting screws set made of stainless steel]

The following set of mounting screws made of stainless steel is also available. Use it in accordance with the operating environment. (Please order the auto switch mounting bracket separately, since it is not included.)

- BBA1: For D-A5/A6/F5/J5 types
- D-F5BA auto switch is set on the cylinder with the stainless steel screws above when shipped. When an auto switch is shipped independently, BBA1 is attached.
- Note 1) Refer to page 1233 for the details of BBA1.
- Note 2) When using D-M9□A(V)/Y7BA, do not use the steel set screws which is included with the auto switch mounting brackets above (BMB5-032, BA7-□□□, BMB4-□□□, BA4-□□□). Order a stainless steel screw set (BBA1) separately, and select and use the M4 x 6L stainless steel set screws included in the BBA1.

- CLJ2
- CLM2
- CLG1
- CL1
- MLGC
- CNG
- MNB**
- CNA2
- CNS
- CLS
- CLQ
- RLQ
- MLU
- MLGP
- ML1C

Besides the models listed in How to Order, the following auto switches are applicable. For detailed specifications, refer to pages 1119 to 1245.

Auto switch type	Model	Electrical entry (Fetching direction)	Features
Reed	D-A93V, A96V	Grommet (Perpendicular)	—
	D-A90V		Without indicator light
	D-A53, A56, Z73, Z76	Grommet (In-line)	—
	D-A67, Z80		Without indicator light
Solid state	D-M9NV, M9PV, M9BV	Grommet (Perpendicular)	—
	D-Y69A, Y69B, Y7PV		Diagnostic indication (2-color indicator)
	D-M9NWV, M9PWV, M9BWW		Water resistant (2-color indicator)
	D-Y7NWV, Y7PWV, Y7BWW		—
	D-M9NAV, M9PAV, M9BAV		Diagnostic indication (2-color indicator)
	D-F59, F5P, J59		Water resistant (2-color indicator)
	D-Y59A, Y59B, Y7P	Grommet (In-line)	—
	D-F59W, F5PW, J59W		Diagnostic indication (2-color indicator)
	D-Y7NW, Y7PW, Y7BW		Water resistant (2-color indicator)
	D-F5BA, Y7BA		With timer
	D-F5NT		Magnetic field resistant (2-color indicator)
	D-P5DW		—

* With pre-wired connector is available for solid state auto switches. For details, refer to pages 1192 and 1193.
 * Normally closed (NC = b contact), solid state auto switch (D-F9G/F9H/Y7G/Y7H type) are also available. For details, refer to pages 1137 and 1139.

- D-□
- X□



MNB Series

Specific Product Precautions 1

Be sure to read this before handling the products. Refer to back page 50 for Safety Instructions and pages 3 to 12 for Actuator and Auto Switch Precautions.

Design of Equipment and Machinery

⚠ Warning

1. Construct so that the human body will not come into direct contact with driven objects or the moving parts of the cylinders with lock.

Devise a safe structure by attaching protective covers that prevent direct contact with the human body, or in cases where there is a danger of contact, provide sensors or other devices to perform an emergency stop, etc., before contact occurs.

2. Use a balance circuit, taking cylinder lurching into consideration.

In cases such as an intermediate stop, where a lock is operated at a desired position within the stroke and air pressure is applied from only one side of the cylinder, the piston will lurch at high speed when the lock is released. In such situations, there is a danger of causing human injury by having hands or feet, etc. caught, and also a danger for causing damage to the equipment. In order to prevent this lurching, a balance circuit such as the recommended pneumatic circuits (pages 914 and 915) should be used.

Selection

⚠ Warning

1. When in the locked state, do not apply a load accompanied by an impact shock, strong vibration or turning force, etc.

Use caution, because an external action such as an impacting load, strong vibration or turning force, may damage the locking mechanism or reduce its life.

2. Consider stopping accuracy and the amount of over-run when an intermediate stop is performed.

Due to the nature of a mechanical lock, there is a momentary lag with respect to the stop signal, and a time delay occurs before stopping. The cylinder stroke resulting from this delay is the overrun amount. The difference between the maximum and minimum overrun amounts is the stopping accuracy.

- Place a limit switch before the desired stopping position, at a distance equal to the overrun amount.
- The limit switch must have a detection length (dog length) of the overrun amount + ΔL .
- SMC's auto switches have operating ranges from 8 to 14 mm (depending on the auto switch model).

When the overrun amount exceeds this range, self-holding of the contact should be performed at the auto switch load side.

* For stopping accuracy, refer to page 891.

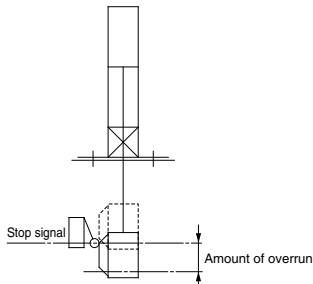

Selection

⚠ Warning

3. In order to further improve stopping accuracy, the time from the stop signal to the operation of the lock should be shortened as much as possible.

To accomplish this, use a device such as a highly responsive electric control circuit or solenoid valve driven by direct current, and place the solenoid valve as close as possible to the cylinder.

4. Note that the stopping accuracy will be influenced by changes in piston speed.

When piston speed changes during the course of the cylinder stroke due to variations in the load or disturbances, etc., the dispersion of stopping positions will increase. Therefore, consideration should be given to establishing a standard speed for the piston just before it reaches the stopping position.

Moreover, the dispersion of stopping positions will increase during the cushioned portion of the stroke and during the accelerating portion of the stroke after the start of operation, due to the large changes in piston speed.

5. The holding force (max. static load) indicates the maximum capability to hold a static load without loads, vibration and impact. This does not indicate a load that can be held in ordinary conditions.

Select the most suitable bore sizes for the operating conditions in accordance with the selection procedures. The Model Selection (pages 888 and 889) is based on use at the intermediate stop (including emergency stops during operation). However, when the cylinder is in a locked state, kinetic energy does not act upon it. Under these conditions, use the load mass at the maximum speed (V) of 100 mm/s shown in graphs (5) to (7) on page 889 depending on the operating pressure and select models.

Mounting

⚠ Warning

1. Be certain to connect the rod end to the load with the lock released.

If connected in the locked state, a load greater than the turning force or holding force, etc. may operate on the piston rod and cause damage to the lock mechanism. MNB series is equipped with an emergency unlocking mechanism, however, when connecting the rod end to the load, this should be done with the lock released. This can be accomplished by simply connecting an air line to the unlocking port and supplying air pressure of 0.25 MPa or more.

2. Do not apply offset loads to the piston rod.

Particular care should be taken to match the load's center of gravity with the center of the cylinder shaft. When there is a large discrepancy, the piston rod may be subjected to uneven wear or damage due to the inertial moment during locking stops.

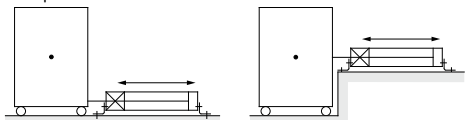

X Load center of gravity and cylinder shaft center are not matched.

O Load center of gravity and cylinder shaft center are matched.

Note) Can be used if all of the generated moment is absorbed by an effective guide.



MNB Series

Specific Product Precautions 2

Be sure to read this before handling the products. Refer to back page 50 for Safety Instructions and pages 3 to 12 for Actuator and Auto Switch Precautions.

Mounting

⚠ Caution

1. Use the hexagon wrenches shown below when replacing brackets.

Bore size (mm)	Bolt	Width across flats	Tightening torque (N·m)
32, 40	MB-32-48-C1247	4	5.1
50, 63	MB-50-48-C1249	5	11
80, 100	Foot	MB-80-48AC1251	6
	Others	MB-80-48BC1251	

2. When replacing the head side bracket, the tie-rod nut on the cylinder body also loosens.

After retightening the tie-rod nut at the proper tightening torque (Refer to Adjustment 1. below.), install the bracket.

3. Do not turn the piston rod with the rod boot kept locked.

When turning the piston rod, loosen the band once and do not twist the rod boot.

Set the breathing hole in the rod boot downward or in the direction that prevents entry of dust or water content.

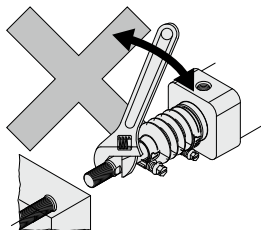

Adjustment

⚠ Warning

1. Do not open the cushion valve beyond the stopper.

As a retaining mechanism for the cushion valve, a crimped section ($\phi 32$ head cover) or retaining ring is installed ($\phi 40$ to $\phi 100$), and the cushion valve should not be opened beyond that point.

If not operated in accordance with the above precautions, the cushion valve may be ejected from the cover when air pressure is supplied.

Bore size (mm)	Cushion valve	Hexagon wrench
32, 40	2.5	JIS 4648 Hexagon wrench key 2.5
50, 63	3.0	JIS 4648 Hexagon wrench key 3
80, 100	4.0	JIS 4648 Hexagon wrench key 4

2. Use the air cushion at the end of cylinder stroke.

If this is not done, the tie-rod or piston assembly will be damaged.

⚠ Caution

1. Adjust the cylinder's air balance.

Balance the load by adjusting the air pressure in the rod and head sides of the cylinder with the load connected to the cylinder and the lock released. Lurching of the cylinder when unlocked can be prevented by carefully adjusting this air balance.

2. Adjust the mounting positions of the detectors on auto switches, etc.

When intermediate stops are to be performed, adjust the mounting positions of detectors on auto switches, etc., taking into consideration the overrun amount with respect to the desired stopping positions.

CLJ2

CLM2

CLG1

CL1

MLGC

CNG

MNB

CNA2

CNS

CLS

CLQ

RLQ

MLU

MLGP

ML1C

D-□

-X□



MNB Series

Specific Product Precautions 3

Be sure to read this before handling the products. Refer to back page 50 for Safety Instructions and pages 3 to 12 for Actuator and Auto Switch Precautions.

Pneumatic Circuit

Warning

1. Be certain to use an pneumatic circuit which will apply balancing pressure to both sides of the piston when in a locked stop.

In order to prevent cylinder lurching after a lock stop, when restarting or when manually unlocking, a circuit should be used to which will apply balancing pressure to both sides of the piston, thereby canceling the force generated by the load in the direction of piston movement.

2. The effective area of the unlocking solenoid valve should be at least 50% of the effective area of the cylinder driving solenoid valve, and it should be installed as close to the cylinder as possible so that it is closer than the cylinder driving solenoid valve.

If the effective area of the unlocking solenoid valve is small or if it is installed at a distance from the cylinder, the time required for exhausting air for unlocking will be longer, which may cause a delay in the locking operation.

The delay in the locking operation may result in problems such as increase of overruning when performing intermediate stop or emergency stop during operation, or if maintaining position from the operation stop state such as drop prevention, workpieces may be dropped depending on the timing of the load action to the operation delay of the lock.

3. Avoid backflow of the exhaust pressure when there is a possibility of interference of exhaust air, for example for a common exhaust type valve manifold.

The lock may not operate properly when the exhaust air pressure backflows due to interference of the exhaust air when exhausting air for lock release. It is recommended to use an individual exhaust type manifold or individual valves.

4. Allow at least 0.5 seconds from a locked stop (intermediate stop of the cylinder) until release of the lock.

When the locked stop time is too short, the piston rod (and load) may lurch at a speed greater than the control speed of the speed controller.

5. When restarting, control the switching signal for the unlocking solenoid valve so that it acts before or at the same time as the cylinder drive solenoid valve.

If the signal is delayed, the piston rod (and load) may lurch at a speed greater than the control speed of the speed controller.

6. Carefully check for dew condensation due to repeated air supply and exhaust of the locking solenoid valve.

The operating stroke of the lock part is very small. So, if the piping is long and the air supply and exhaust are repeated, the dew condensation caused by the adiabatic expansion accumulates in the lock part. This may corrode internal parts, causing air leak or lock release fault.

7. Basic circuit

1. [Horizontal]

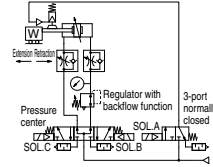

SOLA	SOLB	SOLC	Action
ON	ON	OFF	Extension
OFF	OFF	OFF	Locked stop
ON	OFF	OFF	Unlocked
ON	ON	OFF	Extension
ON	OFF	ON	Retraction
OFF	OFF	OFF	Locked stop
ON	OFF	OFF	Unlocked
ON	OFF	ON	Retraction

0.5 s or more
0 to 0.5 s
0.5 s or more
0 to 0.5 s

2. [Vertical]

[Load in the direction of rod extension]

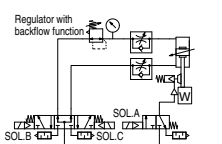

[Load in the direction of rod retraction]

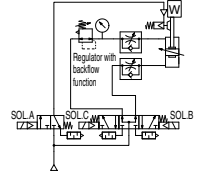

* The symbol for the cylinder with lock in the basic circuit uses SMC original symbol.

Caution

1. 3-position pressure center solenoid valve and regulator with backflow function can be replaced with two 3-port normally open valves and a regulator with relief function.

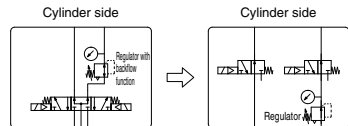

[Example]

1. [Horizontal]

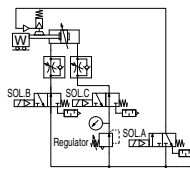

2. [Vertical]

[Load in the direction of rod extension]

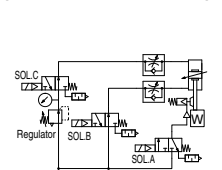

[Load in the direction of rod retraction]

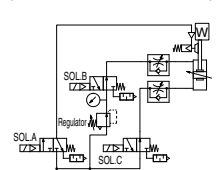

* The symbol for the cylinder with lock in the pneumatic circuit uses SMC original symbol.



MNB Series

Specific Product Precautions 4

Be sure to read this before handling the products. Refer to back page 50 for Safety Instructions and pages 3 to 12 for Actuator and Auto Switch Precautions.

Manually Unlocking

⚠ Warning

1. **Never operate the unlocking cam until safety has been confirmed. (Do not turn to the FREE side.)**
 - When unlocking is performed with air pressure applied to only one side of the cylinder, the moving parts of the cylinder will lurch at high speed causing a serious hazard.
 - When unlocking is performed, be sure to confirm that personnel are not within the load movement range and that no other problems will occur if the load moves.
2. **Before operating the unlocking cam, exhaust any residual pressure which is in the system.**
3. **Take measures to prevent the load from dropping when unlocking is performed.**
 - Perform work with the load in its lowest position.
 - Take measures for drop prevention by strut, etc.

⚠ Caution

1. **The unlocking cam is an emergency unlocking mechanism only.**
During an emergency when the air supply is stopped or cut off, this is used to alleviate a problem by forcibly pushing back the release piston and brake spring to release the lock.
2. **When installing the cylinder into equipment or performing adjustments, etc., be sure to apply air pressure of 0.25 MPa or more to the unlocking port, and do not perform work using the unlocking cam.**
3. **When releasing the lock with the unlocking cam, it must be noted that the internal resistance of the cylinder will be high, unlike normally unlocking with air pressure.**

Bore size (mm)	Cylinder internal resistance (N)	Cam unlocking torque (standard) (N·m)	Width across flats (mm)
32	69	2.0	5.5
40	108	5.9	7
50	275	11.8	8
63	432	12.8	10
80	686	20.6	10
100	765	23.5	12

4. **Do not turn the unlocking cam (the arrow or mark on the unlocking cam head) past the position marked FREE.**
If it is turned too far there is a danger of damaging the unlocking cam.

⚠ Caution

5. **For safety reasons, the unlocking cam is constructed so that it cannot be fixed in the unlocked condition.**

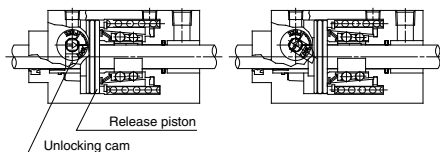

Locked state

Manually unlocked state

[Principle]

If the unlocking cam is turned counterclockwise with a tool such as an adjustable angle wrench, the release piston is pushed back and the lock is released. Since the lever will return to its original position when released and become locked again, it should be held in this position for as long as unlocking is needed.

CLJ2

CLM2

CLG1

CL1

MLGC

CNG

MNB

CNA2

CNS

CLS

CLQ

RLQ

MLU

MLGP

ML1C

D-□

-X□



MNB Series Specific Product Precautions 5

Be sure to read this before handling the products. Refer to back page 50 for Safety Instructions and pages 3 to 12 for Actuator and Auto Switch Precautions.

Maintenance

⚠ Caution

1. The lock units for MNB series are replaceable.

To order replacement lock units for MNB series, use the order numbers given in the table below.

Bore size (mm)	Lock unit part no.
32	MNB 32D-UA
40	MNB 40D-UA
50	MNB 50D-UA
63	MNB 63D-UA
80	MNB 80D-UA
100	MNB100D-UA

2. How to replace lock unit

- Loosen the tie-rod nuts (4 pcs.) on the cylinder head cover side by using a hexagon wrench.
For the applicable hexagon wrench, refer to the table below.

Bore size (mm)	Tie-rod nut socket width across flats (mm)
32, 40	6
50, 63	8
80, 100	10

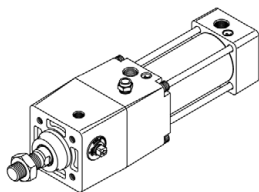

- Remove the tie-rods, head cover and cylinder tube.

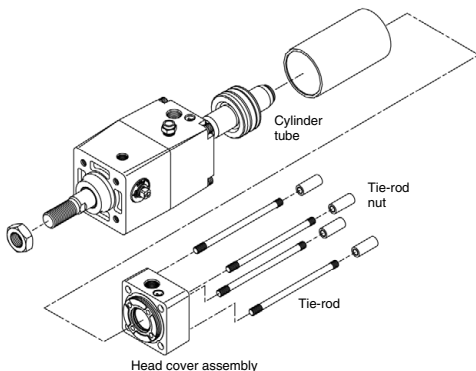

- Apply 0.3 MPa or more of compressed air to the unlocking port, and pull out the piston rod assembly.

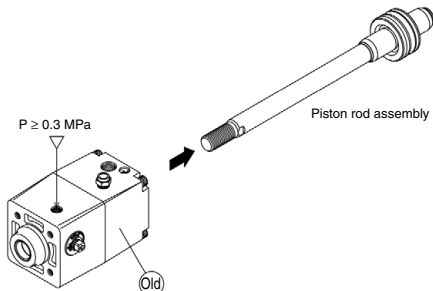

- Similarly, apply 0.3 MPa or more of compressed air to the unlocking port of the new lock unit, and replace the new lock unit's temporary axis with the previous piston rod assembly.

Note) Be sure to keep applying compressed air with a pressure of at least 0.3 MPa to the lock releasing port when replacing the temporary axis of a new lock unit and a piston rod assembly.
If the compressed air applied to the unlocking port is released (when it is in the lock condition) while the temporary axis and the piston rod assembly are removed from the lock unit, the brake shoe will be deformed and it will become impossible to insert the piston rod assembly, which will make the lock unit impossible to use.

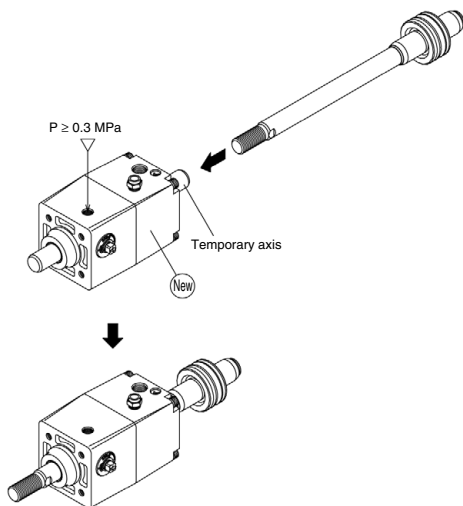

- Reassemble in reverse order from steps 2) and 1).