

Non-rotating Double Power Cylinder

MGZ Series

Double Power Cylinder

MGZR Series (without non-rotating mechanism)

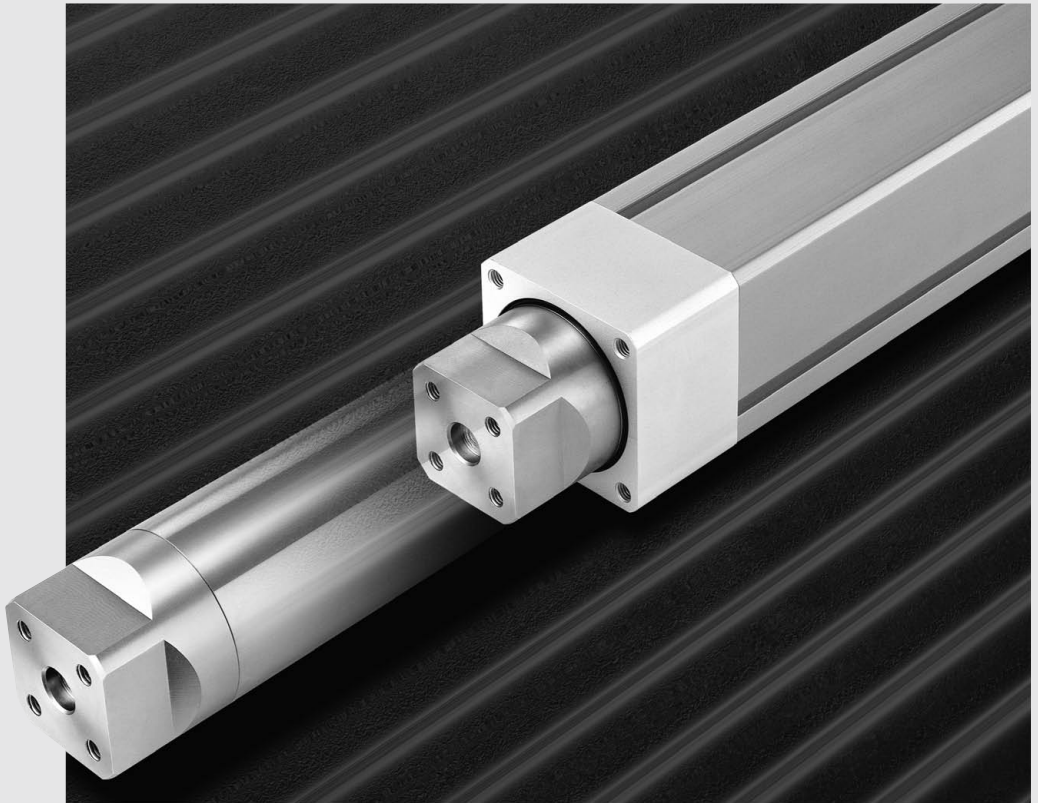

MGJ

JMGP

MGP

MGPW

MGQ

MGG

MGC

MGF

MGZ

MGT



D-□

-X□

Non-rotating Double Power Cylinder

MGZ Series

Double extension output power!!

ø20, ø25, ø32, ø40, ø50, ø63, ø80

Our unique construction doubles the extended piston area. An ideal cylinder for lifting and press applications.

Air pressure supplied from A operates on both surfaces ① and ②. (Extension)

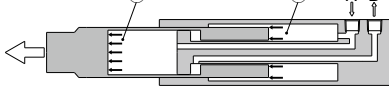

Air pressure supplied from B operates on surfaces ③. (Retraction)

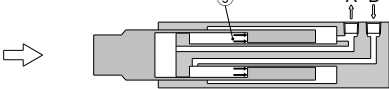

Improved workpiece mounting accuracy

Positioning holes on the workpiece mounting surface allow easy alignment.

Say goodbye to non-rotating guides!! (MGZ Series)

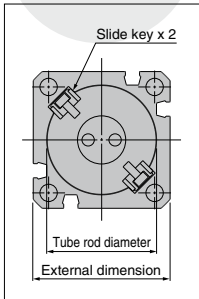

MGZ series employs a slide bearing and a large bore tube rod that accounts for approximately 80% of the cylinder's external diameter. In addition, a built-in non-rotating mechanism using slide keys allows loads to be mounted directly.

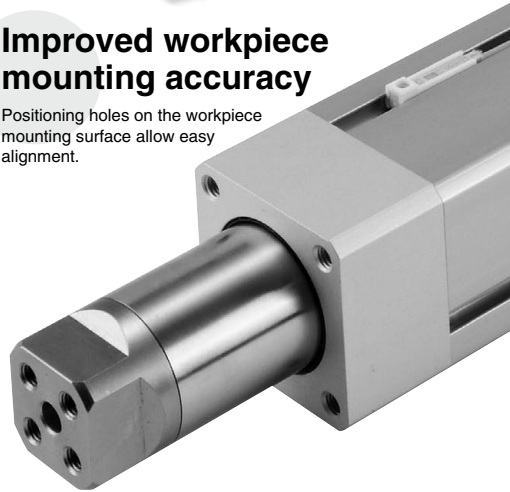

Regulator with check valve is not required.

A regulator with check valve, normally required for a lifting circuit, is no longer necessary.

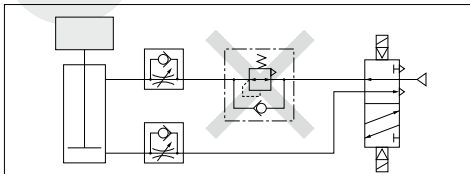

Excellent strength delivered in a small package.

Although moment resistance is equivalent to that of a guided cylinder (cylinder + 2 guide shafts), the installation area has been reduced by approximately 40% (for MGZ series).

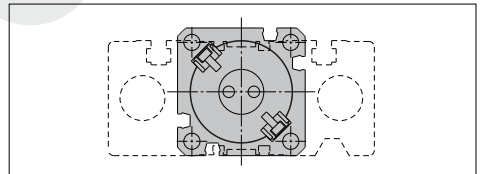

Double Power Cylinder

MGZR Series

(without non-rotating mechanism)

ø20, ø25, ø32, ø40, ø50, ø63, ø80



Flush, unencumbered appearance

Auto switches can be housed in grooves on 4 sides.



Piping is concentrated in the head cover.

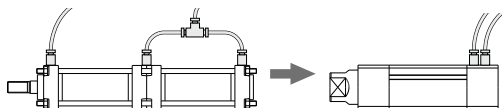

Long stroke available Space-saving

Note)

Strokes up to 1,000 mm are available. Unlike current tandem type double output cylinders, whose length is more than twice the stroke length, our double output cylinders are markedly more compact.

Note) Strokes up to 800 mm are available in bore sizes ø20 and ø25.

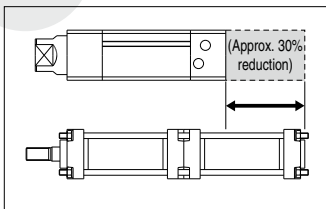

Application Example

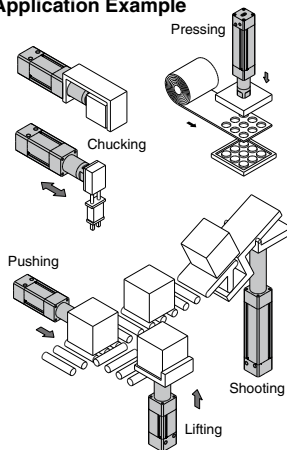

MGJ

JMGP

MGP

MGPW

MGQ

MGG

MGC

MGF

MGZ

MGT

Series Variations

Name	Model	Bore size (mm)	With end lock	With coil scraper	Mounting bracket			
					Transaxial foot type	Front flange type	Rear flange type	Double clevis
Non-rotating double power cylinder	MGZ	20, 25, 32, 40 50, 63, 80	● Note)	●	●	●	●	—
Double power cylinder	MGZR (without non-rotating mechanism)		—	●	●	●	●	●

Note) Except ø20, ø25, ø32 and ø80.

With front end lock on rod side
For drop protection
(MGZ only)



Double clevis type
For rotating applications.
(MGZR only)



With coil scraper

D-□

-X□

MGZ/MGZR Series Model Selection



Theoretical output must be confirmed separately.
Refer to the theoretical output table on page 615.

MGZ Series

1. Confirmation of Allowable Load Mass by Each Application

Selection conditions: Determine which of the conditions below matches your intended application, then choose one of the selection graphs that follow.

Vertical upward: Lifter			Vertical downward: Press		Horizontal: Chucking		
Maximum speed (mm/s)			Maximum speed (mm/s)		Load center of gravity position L (mm)		
Up to 300	Up to 500	Up to 700	Up to 300	Up to 500	Up to 100	Up to 200	Up to 300
Graph (1)	Graph (2)	Graph (3)	Graph (4)	Graph (5)	Graph (6)	Graph (7)	Graph (8)

* L: This dimension indicates the position of the load center of gravity when the cylinder is retracted.
Note) When using with piston rod extended, use caution as it may exceed the allowable energy.

Selection Graph (1) to (3) (Vertical Upward Mounting)

Graph (1) up to 300 mm/s

Solid line: Operating pressure 0.4 MPa or more
Dotted line: Operating pressure 0.5 MPa or more

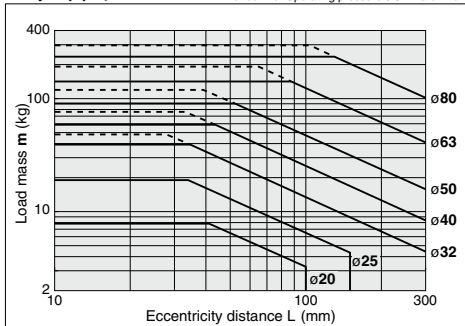

Graph (2) up to 500 mm/s

Solid line: Operating pressure 0.4 MPa or more
Dotted line: Operating pressure 0.5 MPa or more

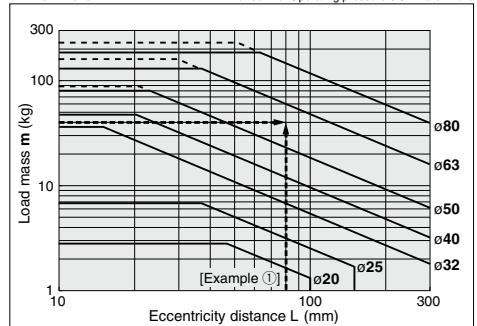

Graph (3) up to 700 mm/s

Solid line: Operating pressure 0.4 MPa or more

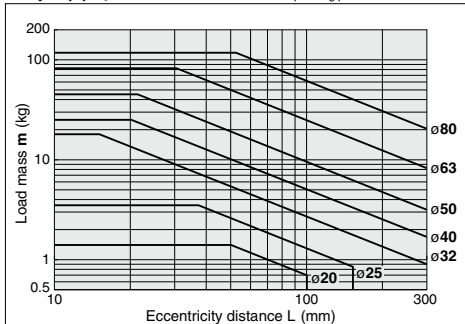

Selection Example:

Vertical Upward Mounting

- ① Selection conditions
- (Mounting: Vertical upward (Lifter)
 - Maximum speed: 500 mm/s
 - Load mass: 40 kg
 - Eccentricity distance: 80 mm

Since the conditions are vertical upward mounting with a speed of 500 mm/s, use graph (2). In the graph, find where the lines representing a load mass of 40 kg and an eccentric distance of 80 mm intersect. From the graph, a ø63 bore size is selected.

Selection Graph (4) and (5) (Vertical Downward Mounting)

Graph (4) up to 300 mm/s

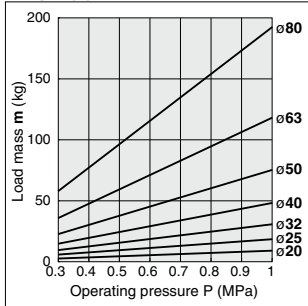

Graph (5) up to 500 mm/s

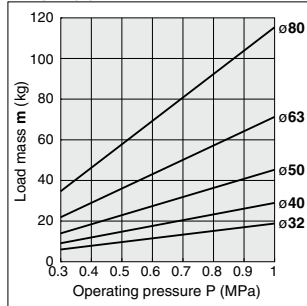

Selection Example: Horizontal Mounting

- ② Selection conditions
 (Mounting: Horizontal (Chucking)
 Stroke: 300 mm
 Load center of gravity position: 100 mm
 Load mass: 10 kg
 Operating pressure: 0.5 MPa

Refer to graph (6) based on the horizontal mounting and the load center of gravity position. In the graph, find where the lines representing a load mass of 10 kg and a stroke of 300 mm intersect. A $\phi 50$ bore size is selected.

The theoretical output for the extension stroke is **1924 N**, from the theoretical out-put table on page 615.

Selection Graph (6) to (8) (Horizontal Mounting)

Graph (6) L: 100 mm or less

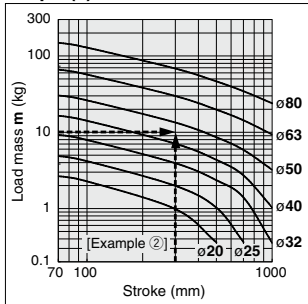

Graph (7) L: 101 to 200 mm

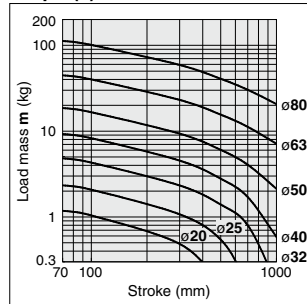

Graph (8) L: 201 to 300 mm

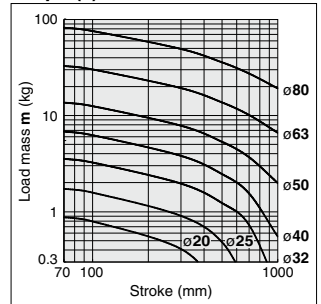

2. Confirmation of allowable rotating torque

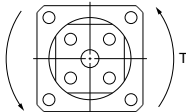

Allowable Rotating Torque

Bore size (mm)	Allowable rotating torque T (Nm)
20	2.7
25	4
32	5
40	7
50	15
63	20
80	30

3. Confirmation of non-rotating accuracy

3-1 Rolling direction

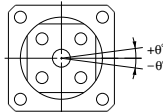

Non-rotating Accuracy

Bore size (mm)	Non-rotating accuracy ($\pm\theta^\circ$)
20	$\pm 0.4^\circ$ or less
25	
32	
40	$\pm 0.3^\circ$ or less
50	
63	
80	

3-2 Pitching direction

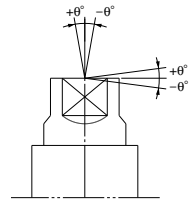

Deflection Angle of Eccentric Load

Bore size (mm)	Non-rotating accuracy ($\pm\theta^\circ$)
20	$\pm 0.12^\circ$ or less
25	
32	
40	
50	
63	
80	

MGJ

JMGP

MGP

MGPW

MGQ

MGG

MGC

MGF

MGZ

MGT

D-□

-X□

MGZR Series

MGZR Series (without non-rotating mechanism)

1. Find the Bore Size of the Cylinder Tube

Selection conditions: Determine which of the conditions below matches your intended application, then choose one of the selection graphs that follow.

Vertical upward load			Load extended horizontally			Load retracted horizontally	
Maximum speed (mm/s)			Maximum speed (mm/s)			Maximum speed (mm/s)	
Up to 300	Up to 500	Up to 700	Up to 300	Up to 500	Up to 700	Up to 300	Up to 450
Graph (1)	Graph (2)	Graph (3)	Graph (4)	Graph (5)	Graph (6)	Graph (7)	Graph (8)

Selection Graph (1) to (3) (Vertical Upward Load)

Graph (1) up to 300 mm/s

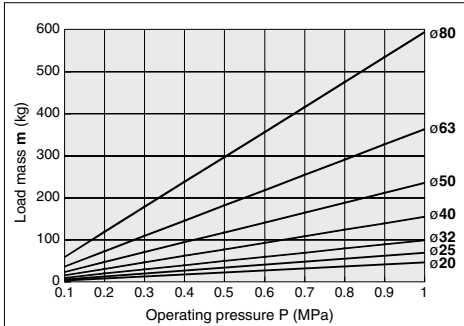

Graph (2) up to 500 mm/s

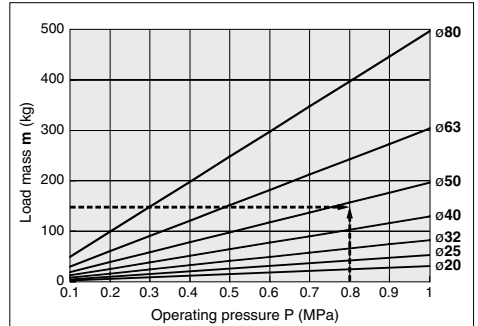

Graph (3) up to 700 mm/s

Solid line: Operating pressure 0.4 MPa or more

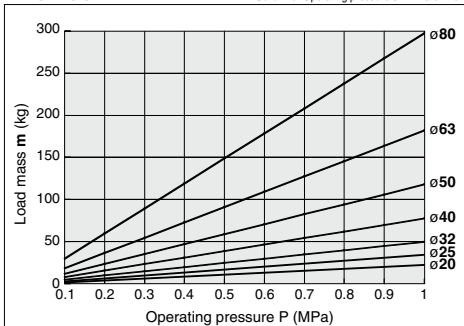

Selection Example: Vertical Upward Load

- ① Selection conditions
- Mounting: Vertical upward
 - Maximum speed: 500 mm/s
 - Operating pressure: 0.8 MPa
 - Load mass: 150 kg

Since the conditions are vertical upward mounting with a speed of 500 mm/s, use graph (2). In the graph, find where the lines representing an operating pressure of 0.8 MPa and a load mass of 150 kg intersect. A ø50 bore size is selected.

**Selection Graph (4), (5), and (6)
(Load Extended Horizontally)**

Graph (4) up to 300 mm/s

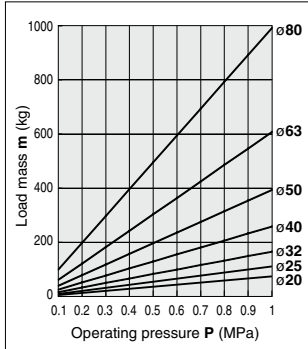

Graph (5) up to 500 mm/s

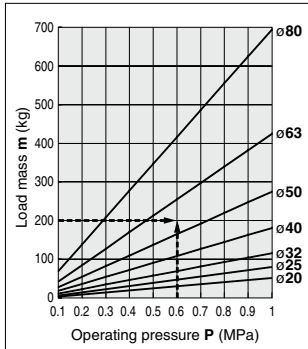

Graph (6) up to 700 mm/s

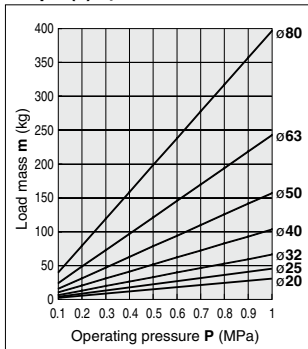

**Selection Graph (7) and (8)
(Load Retracted Horizontally)**

Graph (7) up to 300 mm/s

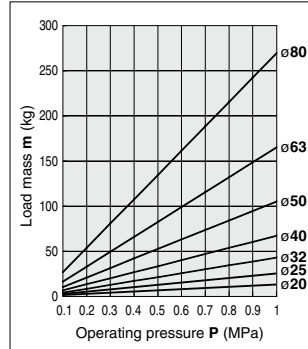

Graph (8) up to 450 mm/s

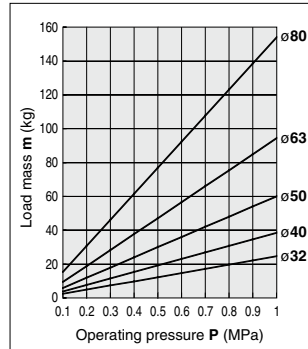

**Selection Example:
Load Extended Horizontally**

② Selection conditions

Mounting: Horizontal extension
Maximum speed: 500 mm/s
Operating pressure: 0.6 MPa
Load mass: 200 kg

Since the conditions are horizontal extension with a speed of 500 mm/s, use graph (5). In the graph, find where the lines representing an operating pressure of 0.6 MPa and a load mass of 200 kg intersect. A ø63 bore size is selected.

2. Confirmation of allowable kinetic energy

Confirm the strength of the built-in stopper (rubber bumper) based on the correlation of load mass and the maximum speed. If the value is

Above the line in the graph: A built-in stopper can be used.

Below the line in the graph: Either use a cylinder with a larger bore size or install an external stopper

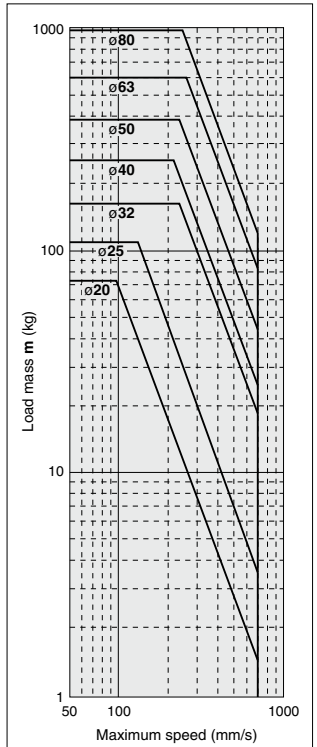

- MGJ
- JMGP
- MGP
- MGPW
- MGQ
- MGG
- MGC
- MGF
- MGZ
- MGT

- D-□
- X□

Non-rotating Double Power Cylinder

MGZ Series

ø20, ø25, ø32, ø40, ø50, ø63, ø80

How to Order

MGZ **40** **Z** - **100** - **M9BW** -

Mounting type

Nil	Basic type
L	Transaxial foot type
F	Rod flange type
G	Head flange type

Bore size

20	20 mm
25	25 mm
32	32 mm
40	40 mm
50	50 mm
63	63 mm
80	80 mm

Thread type

Nil	M5 x 0.8	ø20
	Rc	ø25
TN	NPT	ø32
		ø40
TF	G	ø50
		ø63
		ø80

Made to Order
For details, refer to page 615.

Number of auto switches

Nil	2 pcs.
S	1 pc.
n	"n" pcs.

Auto switch

Nil	Without auto switch (Built-in magnet)
-----	---------------------------------------

* For the applicable auto switch model, refer to the table below.

Cylinder stroke (mm)
Refer to "Standard Stroke" on page 615.

Coil scraper

Nil	None
Z	Yes

Applicable Auto Switches

Refer to pages 1119 to 1245 for detailed specifications of auto switches.

Type	Special function	Electrical entry	Indicator light	Wiring (Output)	Load voltage		Auto switch model		Lead wire length (m)				Pre-wired connector	Applicable load			
					DC	AC	Perpendicular	In-line	0.5 (Nil)	1 (M)	3 (L)	5 (Z)		IC circuit	Relay, PLC		
																M9NV	M9N
Solid state auto switch	—	Grommet	Yes	3-wire (NPN)	24 V	5 V, 12 V	—	M9NV	M9N	●	●	●	○	○	Relay, PLC		
				3-wire (PNP)				M9PV	M9P	●	●	●	○	○			
				2-wire	M9BV	M9B	●	●	●	○	○						
	3-wire (NPN)			M9NWV	M9NW	●	●	●	○	○							
	3-wire (PNP)			M9PWV	M9PW	●	●	●	○	○							
	2-wire			M9B WV	M9B W	●	●	●	○	○							
Reed auto switch	—	Grommet	Yes	3-wire (NPN equiv.)	24 V	12 V	100 V 100 V or less	A96V	A96	●	—	●	—	—	IC circuit	—	
				2-wire				A93V ^{*2}	A93	●	●	●	●	—	—	Relay, PLC	
				No	3-wire (NPN equiv.)	A90V	A90	●	—	●	—	—	—	IC circuit	—		
					2-wire	A93V ^{*2}	A93	●	●	●	●	—	—	Relay, PLC			
					3-wire (NPN equiv.)	A96V	A96	●	—	●	—	—	—	IC circuit	—		
					2-wire	A93V ^{*2}	A93	●	●	●	●	—	—	Relay, PLC			

*1 Water resistant type auto switches can be mounted on the above models, but in such case SMC cannot guarantee water resistance. Consult with SMC regarding water resistant types with the above model numbers.

*2 1 m type lead wire is only applicable to D-A93.

* Lead wire length symbols: 0.5 m Nil (Example) M9NW
 1 m M (Example) M9NWM
 3 m L (Example) M9NWL
 5 m Z (Example) M9NWX

* Solid state auto switches marked "○" are produced upon receipt of order.

* Refer to page 631 for applicable auto switches other than listed above.

* Refer to pages 1192 and 1193 for details of auto switches with a pre-wired connector.

* Auto switches are shipped together (not assembled).

Non-rotating Double Power Cylinder **MGZ Series**

Specifications

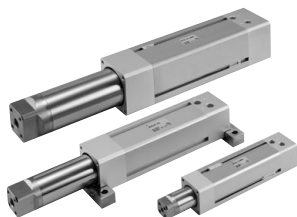

Bore size (mm)		20	25	32	40	50	63	80
Action		Double acting, Single rod						
Fluid		Air						
Proof pressure		1.5 MPa						
Max. operating pressure		1.0 MPa						
Min. operating pressure		Standard stroke: 0.08 MPa						
		Long stroke: 0.12 MPa						
Ambient and fluid temperature		Without auto switch: -10° to 70°C (With no freezing)						
		With auto switch: -10° to 60°C (With no freezing)						
Lubrication		Non-lube						
Piston speed	OUT	50 to 700 mm/s						
	IN	50 to 350 mm/s		50 to 450 mm/s				
Stroke length tolerance		Up to 250 ^{+1.0} ₀ , 251 to 1000 ^{+1.0} ₀						
Cushion		Rubber bumper						
Mounting		Basic type, Transaxial foot type, Rod flange type, Head flange type						



Made to Order: Individual Specifications
(Refer to page 632 for details.)

Symbol	Specifications
-X1247	Rod end female thread: 1 pc.

Standard Stroke

Bore sizes (mm)	Standard stroke (mm)	Long stroke (mm)
20, 25	75, 100, 125, 150, 175 200, 250, 300	350, 400, 450, 500 600, 700, 800
32, 40, 50 63, 80	75, 100, 125, 150, 175 200, 250, 300	350, 400, 450, 500, 600 700, 800, 900, 1000

Intermediate strokes and strokes shorter than 75 mm are also available.

Weight

Bore size (mm)		20	25	32	40	50	63	80	
Standard weight	Basic type	0.47	0.69	1.04	1.90	3.03	4.83	8.63	
	Foot type	0.63	0.86	1.34	2.39	3.92	6.08	10.61	
	Flange type	0.58	0.83	1.32	2.34	3.79	5.83	9.92	
Weight per each 50 mm of stroke		All mounting brackets	0.18	0.21	0.28	0.39	0.59	0.78	1.17

Theoretical Output

Model	Bore size (mm)	Rod size (mm)	Operating direction	Piston area (mm ²)	Operating pressure (MPa)									
					0.2	0.3	0.4	0.5	0.6	0.7	0.8	0.9	1.0	
MGZ20	20 x 25	10	OUT	726	145	218	290	363	436	508	581	653	726	
	20		IN	236	47	71	94	118	141	165	189	212	236	
MGZ25	25 x 30	12	OUT	1085	217	326	434	543	651	760	868	977	1085	
	25		IN	378	76	113	151	189	227	265	302	340	378	
MGZ32	36 x 32	16	OUT	1621	324	486	648	811	973	1135	1297	1459	1621	
	32		IN	603	121	181	241	302	362	422	482	543	603	
MGZ40	45 x 40	20	OUT	2533	507	760	1013	1267	1520	1773	2026	2280	2533	
	40		IN	942	188	283	377	471	565	659	754	848	942	
MGZ50	55 x 50	25	OUT	3848	770	1154	1539	1924	2309	2694	3078	3463	3848	
	50		IN	1473	295	442	589	737	884	1031	1178	1326	1473	
MGZ63	68 x 63	32	OUT	5945	1189	1784	2378	2973	3567	4162	4756	5351	5945	
	63		IN	2313	463	694	925	1157	1388	1619	1850	2082	2313	
MGZ80	87 x 80	40	OUT	9715	1943	2915	3886	4858	5829	6801	7772	8744	9715	
	80		IN	3770	754	1131	1508	1885	2262	2639	3016	3393	3770	

Mounting Bracket Part No.

Bore size (mm)	20	25	32	40	50	63	80
Foot	MGZ-L02	MGZ-L25	MGZ-L03	MGZ-L04	MGZ-L05	MGZ-L06	MGZ-L08
Flange	MGZ-F02	MGZ-F25	MGZ-F03	MGZ-F04	MGZ-F05	MGZ-F06	MGZ-F08

Note) Accessories for each mounting bracket are as follows.
Foot, Flange: Body mounting bolts

MGJ

JMGP

MGP

MGPW

MGQ

MGG

MGC

MGF

MGZ

MGT

D-□

-X□

MGZ Series

Construction

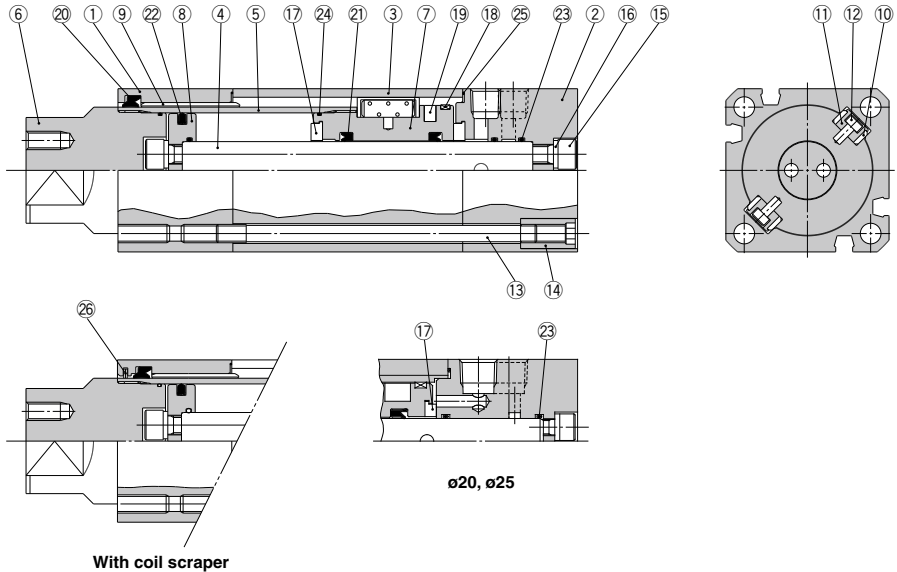

Component Parts

No.	Description	Material	Note
1	Rod cover	Aluminum alloy	Clear anodized
2	Head cover	Aluminum alloy	Clear anodized
3	Cylinder tube	Aluminum alloy	Hard anodized
4	Piston rod	Aluminum alloy	Hard anodized
5	Tube rod	Carbon steel tube	Hard chromium electroplated
6	Tube rod cover	Carbon steel	Electroless nickel plated
7	Piston	Aluminum alloy	Chromated
8	Stationary piston	Aluminum alloy	Chromated
9	Bushing	Bearing alloy	
10	Thrust plate	Bearing alloy	
11	Holder	Aluminum alloy	Chromated
12	Pin	Carbon steel	Zinc chromated
13	Tie-rod	Carbon steel	Corrosion resistant chromated

No.	Description	Material	Note
14	Tie-rod nut	Carbon steel	Nickel plated
15	Hexagon socket head screw	Chrome molybdenum steel	Zinc trivalent chromated
16	Spring washer	Steel wire	Zinc trivalent chromated
17	Bumper	Urethane rubber	
18	Wear ring	Resin	
19	Magnet	—	
20*	Rod seal A	NBR	
21	Rod seal B	NBR	
22	Piston seal	NBR	
23	Piston gasket	NBR	
24	Tube rod gasket	NBR	
25*	Cylinder tube gasket	NBR	
26	Coil scraper	Metal	

Replacement Parts/Seal Kit

Bore size (mm)	Kit no.	Contents
20	MGZ20-PS	Items 20 and 25 from the above chart
25	MGZ25-PS	
32	MGZ32-PS	
40	MGZ40-PS	
50	MGZ50-PS	
63	MGZ63-PS	
80	MGZ80-PS	

* Seal kits consist of items 20 and 25, and can be ordered by using the seal kit number corresponding to each bore size.

* Seal kit includes a grease pack (ø20 to ø50: 10 g, ø63, 80: 20 g).

Order with the following part number when only the grease pack is needed.

Grease pack part no.: GR-S-010 (10 g), GR-S-020 (20 g)

Dimensions

Basic type

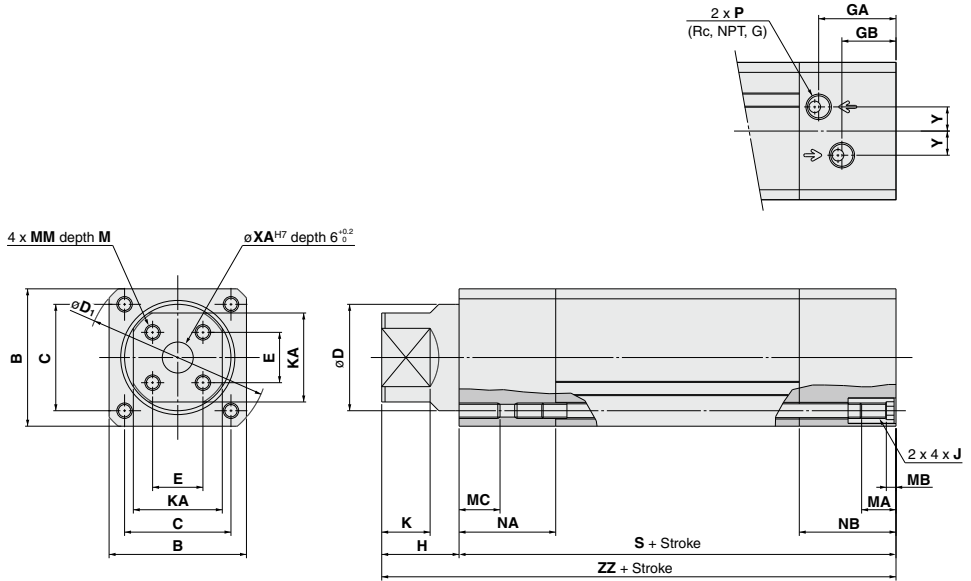

Bore size (mm)	Stroke range	B	C	D	E	KA	GA	GB	H	D ₁	J	K	M
20	Up to 800	39	29	25	11	21	16	12.5	20	51	M5 x 0.8	11	8
25	Up to 800	43	33	30	12	24	26	18	21	57	M5 x 0.8	12	8
32	Up to 1000	49	38	36	16	30	28.5	19.5	35	66	M6 x 1	22	10
40	Up to 1000	59	46	45	21	36	34.5	23.5	40	78	M6 x 1	25	10
50	Up to 1000	71	55	55	26	46	40	28	45	92	M8 x 1.25	25	14
63	Up to 1000	82	66	68	32	53	46.5	34.5	50	110	M8 x 1.25	25	14
80	Up to 1000	106	86	87	36	65	54	36	50	144	M12 x 1.75	25	20

Bore size (mm)	Stroke range	MA	MB	MC	MM	NA	NB	P	S	XA	Y	ZZ
20	Up to 800	11	4	10	M5 x 0.8	19	21	M5 x 0.8	86	6	5	106
25	Up to 800	11	4	10	M5 x 0.8	26	34	1/8	107	6	6.5	128
32	Up to 1000	16	4	12	M6 x 1		37	1/8	120	12	8.5	155
40	Up to 1000	16	4	12	M6 x 1		44	1/4	138	12	9.5	178
50	Up to 1000	16	5	15	M8 x 1.25		50	1/4	150	16	12.5	195
63	Up to 1000	16	5	15	M8 x 1.25		56	1/4	171	16	15	221
80	Up to 1000	20	6	23	M12 x 1.75		66	3/8	198	20	20	248

MGJ

JMGP

MGP

MGPW

MGQ

MGG

MGC

MGF

MGZ

MGT

D-□

-X□

MGZ Series

Dimensions: With Mounting Bracket

Transaxial foot type: (L)

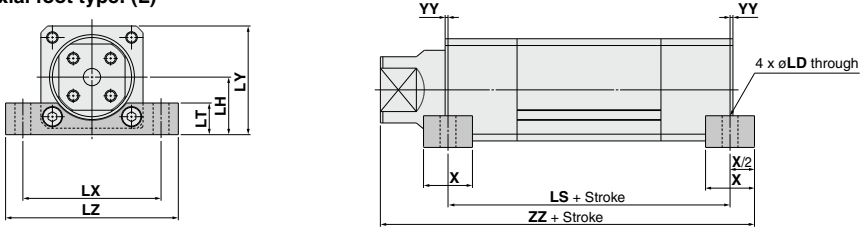

Bore size (mm)	Stroke range	X	YY	LD	LH	LT	LX	LY	LZ	LS	ZZ
20	Up to 800	16	0	6.6	22	13	58	41.5	72	86	114
25	Up to 800	16	0	6.6	24	14	62	45.5	75	107	136
32	Up to 1000	22	0	9	27.5	16	70	52	88	120	166
40	Up to 1000	24	0	9	34	19	80	63.5	100	138	190
50	Up to 1000	32	1	11	40	22	96	75.5	120	148	210
63	Up to 1000	36	3	13	47	24	110	88	140	165	236
80	Up to 1000	40	3	17	59	30	146	112	180	192	265

Rod flange type: (F)

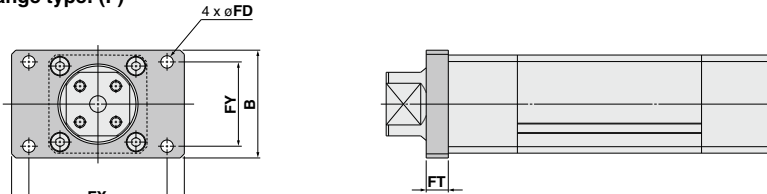

Bore size (mm)	Stroke range	B	FD	FT	FX	FY	FZ
20	Up to 800	44	5.5	8	50	34	60
25	Up to 800	48	6.6	8	57	36	70
32	Up to 1000	60	9	12	64	46	78
40	Up to 1000	74	9	12	80	58	100
50	Up to 1000	78	9	16	100	61	125
63	Up to 1000	100	12	16	112	75	138
80	Up to 1000	120	14	16	132	95	155

Head flange type: (G)

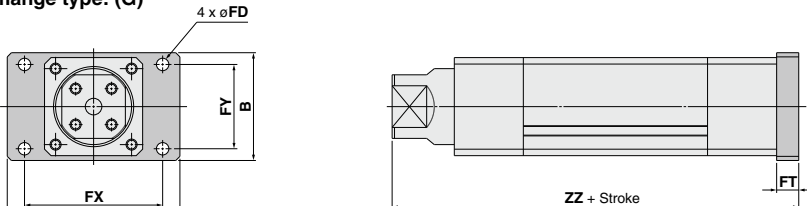

Bore size (mm)	Stroke range	B	FD	FT	FX	FY	FZ	ZZ
20	Up to 800	44	5.5	8	50	34	60	114
25	Up to 800	48	6.6	8	57	36	70	136
32	Up to 1000	60	9	12	64	46	78	167
40	Up to 1000	74	9	12	80	58	100	190
50	Up to 1000	78	9	16	100	61	125	211
63	Up to 1000	100	12	16	112	75	138	237
80	Up to 1000	120	14	16	132	95	155	264

Non-rotating Double Power Cylinder With End Lock on Rod Side

MGZ Series

ø40, ø50, ø63

How to Order

With end lock

MGZ 40 - 100R - M9BW -

Mounting type

Nil	Basic type
L	Transaxial foot type
F	Rod flange type
G	Head flange type

Bore size

40	40 mm
50	50 mm
63	63 mm

Thread type

Nil	Rc
TN	NPT
TF	G

Made to Order

For details, refer to page 620.

Number of auto switches

Nil	2 pcs.
S	1 pc.
n	"n" pcs.

Auto switch

Nil	Without auto switch (Built-in magnet)
-----	---------------------------------------

* For the applicable auto switch model, refer to the table below.

With end lock on rod side

Cylinder stroke (mm)

Refer to "Standard Stroke" on page 620.

Applicable Auto Switches

Refer to pages 1119 to 1245 for detailed specifications of auto switches.

Type	Special function	Electrical entry	Indicator light	Wiring (Output)	Load voltage		Auto switch model		Lead wire length (m)				Pre-wired connector	Applicable load			
					DC	AC	Perpendicular	In-line	0.5 (Nil)	1 (M)	3 (L)	5 (Z)					
															24 V	5 V, 12 V	M9NV
Solid state auto switch	—	Grommet	Yes	3-wire (NPN)	5 V, 12 V	—	—	M9PV	M9P	●	●	●	○	○	IC circuit		
				3-wire (PNP)				M9BV	M9B	●	●	●	○	○			
				2-wire	M9NV			M9N	●	●	●	○	○				
	3-wire (NPN)			M9PWV	M9PW			●	●	●	○	○	IC circuit				
	3-wire (PNP)			M9BWW	M9BW			●	●	●	○	○					
	2-wire			M9NAV ^{*1}	M9NA ^{*1}			○	○	●	○	○		IC circuit			
Water resistant (2-color indicator)	Grommet	No	3-wire (NPN)	5 V, 12 V	—	—	M9PAV ^{*1}	M9PA ^{*1}	○	○	●	○	○		IC circuit		
			3-wire (PNP)				M9BAV ^{*1}	M9BA ^{*1}	○	○	●	○	○				
			2-wire	A96V			A96	●	—	●	—	—	IC circuit				
—	Grommet	Yes	3-wire (NPN equiv.)	24 V			12 V	100 V	A93V ^{*2}	A93	●	—		●		—	Relay, PLC
			2-wire						A90V	A90	●	—		●		—	
			100 V or less														

*1 Water resistant type auto switches can be mounted on the above models, but in such case SMC cannot guarantee water resistance.

*2 Consult with SMC regarding water resistant types with the above model numbers.

*2 1 m type lead wire is only applicable to D-A93.

* Lead wire length symbols: 0.5 m Nil (Example) M9NV
 1 m M (Example) M9NWM
 3 m L (Example) M9NWL
 5 m Z (Example) M9NWX

* Solid state auto switches marked "○" are produced upon receipt of order.

* Refer to page 631 for applicable auto switches other than listed above.

* Refer to pages 1192 and 1193 for details of auto switches with a pre-wired connector.

* Auto switches are shipped together (not assembled).

MGJ

JMGP

MGP

MGPW

MGQ

MGG

MGC

MGF

MGZ

MGT

D-□

-X□

MGZ Series



Cylinder Specifications

Bore size (mm)	40	50	63
Action	Double acting, Single rod		
Fluid	Air		
Proof pressure	1.5 MPa		
Max. operating pressure	1.0 MPa		
Min. operating pressure	0.2 MPa*		
Ambient and fluid temperature	Without auto switch: -10° to 70°C (With no freezing)		
	With auto switch: -10° to 60°C (With no freezing)		
Lubrication	Non-lube		
Piston speed	OUT 50 to 700 mm/s		
	IN 50 to 450 mm/s		
Stroke length tolerance	Up to 250 ^{+1.0} ₀ , 251 to 1000 ^{+1.4} ₀		
Cushion	Rubber bumper		
Mounting	Basic type, Transaxial foot type, Rod flange type, Head flange type		

* 0.08 MPa (or 0.12 MPa for long strokes) except the lock part.



Made to Order; Individual Specifications
(Refer to page 632 for details.)

Symbol	Specifications
-X1247	Rod end female thread: 1 pc.

Lock Specifications

End lock position	Rod side only		
Holding force (max) N	ø40	ø50	ø63
	1770	2690	4160
Backlash	2 mm or less		
Manual release	Non-locking type		

Adjust the switch position so that it operates upon movement to both the stroke end and backlash (2 mm) position.

Standard Stroke

Bore sizes (mm)	Standard strokes (mm)	Long strokes (mm)
40, 50, 63	75, 100, 125, 150, 175 200, 250, 300	350, 400, 450, 500, 600 700, 800, 900, 1000

Intermediate strokes and strokes shorter than 75 mm are also available.

Weight

(kg)

Bore sizes (mm)		40	50	63
Standard weight	Basic type	2.80	4.08	6.13
	Foot type	3.29	4.97	7.39
	Flange type	3.24	4.84	7.13
Weight per each 50 mm of stroke	All mounting brackets	0.41	0.61	0.80

Theoretical Output

(N)

Model	Bore size (mm)	Rod size (mm)	Operating direction	Piston area (mm ²)	Operating pressure (MPa)								
					0.2	0.3	0.4	0.5	0.6	0.7	0.8	0.9	1.0
MGZ40	45 x 40	20	OUT	2533	507	760	1013	1267	1520	1773	2026	2280	2533
	40		IN	942	188	283	377	471	565	659	754	848	942
MGZ50	55 x 50	25	OUT	3848	770	1154	1539	1924	2309	2694	3078	3463	3848
	50		IN	1473	295	442	589	737	884	1031	1178	1326	1473
MGZ63	68 x 63	32	OUT	5945	1189	1784	2378	2973	3567	4162	4756	5351	5945
	63		IN	2313	463	694	925	1157	1388	1619	1850	2082	2313

Mounting Bracket Part No.

Bore size (mm)	40	50	63
Foot	MGZ-L04	MGZ-L05	MGZ-L06
Flange	MGZ-F04	MGZ-F05	MGZ-F06

(Note) Accessories for each mounting bracket are as follows.
Foot, Flange: Body mounting bolts

Non-rotating Double Power Cylinder With End Lock on Rod Side **MGZ Series**

Construction

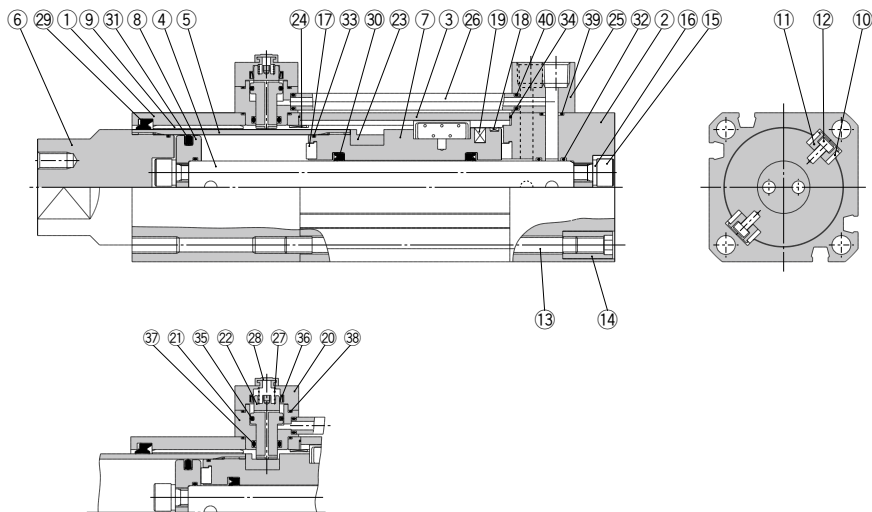

End lock

Component Parts

No.	Description	Material	Note
1	Rod cover	Aluminum alloy	Clear anodized
2	Head cover	Aluminum alloy	Clear anodized
3	Cylinder tube	Aluminum alloy	Hard anodized
4	Piston rod	Aluminum alloy	Hard anodized
5	Tube rod	Carbon steel tube	Hard chromium electroplated
6	Tube rod cover	Carbon steel	Electroless nickel plated
7	Piston	Aluminum alloy	Chromated
8	Stationary piston	Aluminum alloy	Chromated
9	Bushing		
10	Thrust plate		
11	Holder	Aluminum alloy	Chromated
12	Pin	Carbon steel	Zinc chromated
13	Tie-rod	Carbon steel	Corrosion resistant chromated
14	Tie-rod nut	Carbon steel	Nickel plated
15	Hexagon socket head screw	Chrome molybdenum steel	Zinc trivalent chromated
16	Spring washer	Steel wire	Zinc trivalent chromated
17	Bumper	Urethane rubber	
18	Wear ring	Resin	
19	Magnet	—	
20	Cap	Bronze alloy	Electroless nickel plated

No.	Description	Material	Note
21	Lock holder	Stainless steel	
22	Lock piston	Carbon steel	Quenched, hard chromium electroplated
23	Stopper	Carbon steel	Quenched
24	Collar	Steel piping	Zinc trivalent chromated
25	Port block	Bronze alloy	Electroless nickel plated
26	Pipe	Bronze alloy	
27	Lock spring	Steel wire	
28	Rubber cap	Synthetic rubber	
29 [§]	Rod seal A	NBR	
30	Rod seal B	NBR	
31	Piston seal	NBR	
32	Piston gasket	NBR	
33	Tube rod gasket	NBR	
34 [§]	Cylinder tube gasket	NBR	
35 [§]	Locking piston seal A	NBR	
36 [§]	Locking piston seal B	NBR	
37 [§]	Locking piston seal C	NBR	
38 [§]	Lock holder gasket	NBR	
39 [§]	Port block gasket	NBR	
40 [§]	Pipe gasket	NBR	

Replacement Parts/Seal Kit

Bore size (mm)	Kit no.	Contents
40	MGZ40R-PS	Items 29, and 34 to 40 from the above chart
50	MGZ50R-PS	
63	MGZ63R-PS	

* Seal kits consist of items 29 and 34 to 40, and can be ordered by using the seal kit number corresponding to each bore size.

* Seal kit includes a grease pack (10 g).

Order with the following part number when only the grease pack is needed.

Grease pack part no.: GR-S-010 (10 g)

MGJ

JMGP

MGP

MGPW

MGQ

MGG

MGC

MGF

MGZ

MGT

D-□

-X□

MGZ Series

Dimensions

Basic type

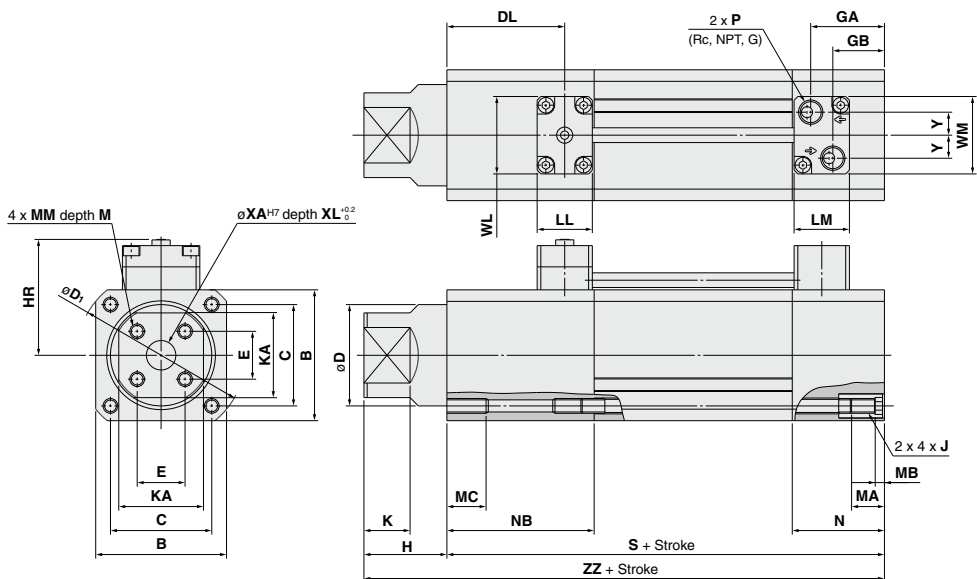

(mm)

Bore size (mm)	Stroke range	B	C	D	DL	E	GA	GB	H	HR	D ₁	J	K	KA	LL	LM
40	Up to 1000	59	46	45	58	21	34.5	23.5	40	57.5	78	M6 x 1	25	36	30	30
50	Up to 1000	71	55	55	67	26	40	28	45	63.5	92	M8 x 1.25	25	46	30	30
63	Up to 1000	82	66	68	73	32	46.5	34.5	50	69	110	M8 x 1.25	25	53	30	30

Bore size (mm)	Stroke range	M	MA	MB	MC	MM	N	NB	P	S	XA	XL	Y	WL	WM	ZZ
40	Up to 1000	10	16	4	12	M6 x 1	44	74	1/4	168	12	6	9.5	42	39	208
50	Up to 1000	14	16	5	15	M8 x 1.25	50	83	1/4	183	16	6	12.5	42	42	228
63	Up to 1000	14	16	5	15	M8 x 1.25	56	89	1/4	204	16	6	15	52	52	254

Dimensions: With Mounting Bracket

Transaxial foot type: (L)

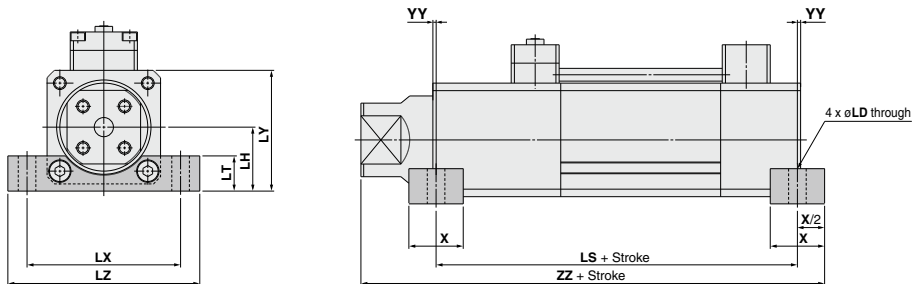

(mm)

Bore size (mm)	Stroke range	X	YY	LD	LH	LT	LX	LY	LZ	LS	ZZ
40	Up to 1000	24	0	9	34	19	80	63.5	100	168	220
50	Up to 1000	32	1	11	40	22	96	75.5	120	181	243
63	Up to 1000	36	3	13	47	24	110	88	140	198	269

Rod flange type: (F)

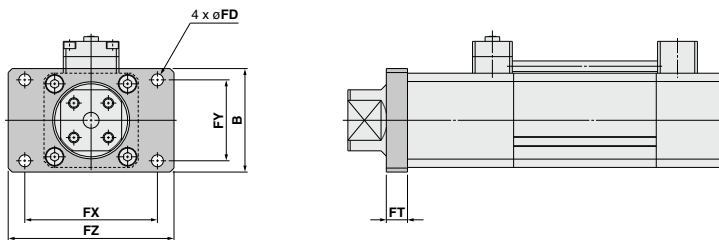

(mm)

Bore size (mm)	Stroke range	B	FD	FT	FX	FY	FZ
40	Up to 1000	74	9	12	80	58	100
50	Up to 1000	78	9	16	100	61	125
63	Up to 1000	100	12	16	112	75	138

Head flange type: (G)

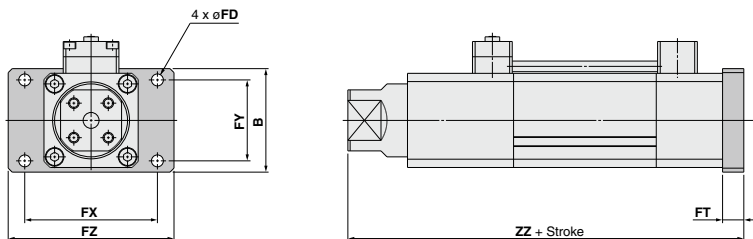

(mm)

Bore size (mm)	Stroke range	B	FD	FT	FX	FY	FZ	ZZ
40	Up to 1000	74	9	12	80	58	100	220
50	Up to 1000	78	9	16	100	61	125	244
63	Up to 1000	100	12	16	112	75	138	270

MGJ

JMGP

MGP

MGPW

MGQ

MGG

MGC

MGF

MGZ

MGT

D-□

-X□

Double Power Cylinder/ Without Non-rotating Mechanism

MGZR Series

ø20, ø25, ø32, ø40, ø50, ø63, ø80

How to Order

MGZR 40 Z - 100 - M9BW - -

Without non-rotating mechanism

Mounting type

Nil	Basic type
L	Transaxial foot type
F	Rod flange type
G	Head flange type
D	Double clevis type

Bore size

20	20 mm
25	25 mm
32	32 mm
40	40 mm
50	50 mm
63	63 mm
80	80 mm

Thread type

Nil	M5 x 0.8	ø20
	Rc	ø25
TN	NPT	ø32
		ø40
TF	G	ø50
		ø63
		ø80

Made to Order
For details, refer to page 625.

Number of auto switches

Nil	2 pcs.
S	1 pc.
n	"n" pcs.

Auto switch

Nil	Without auto switch (Built-in magnet)
-----	---------------------------------------

* For the applicable auto switch model, refer to the table below.

Cylinder stroke (mm)

Refer to "Standard Stroke" on page 625.

Coil scraper

Nil	Without coil scraper
Z	With coil scraper

Applicable Auto Switches

Refer to pages 1119 to 1245 for detailed specifications of auto switches.

Type	Special function	Electrical entry	Indicator light	Wiring (Output)	Load voltage		Auto switch model		Lead wire length (m)				Pre-wired connector	Applicable load			
					DC	AC	Perpendicular	In-line	0.5 (Nil)	1 (M)	3 (L)	5 (Z)		IC circuit	Relay, PLC		
Solid state auto switch	—	Grommet	Yes	3-wire (NPN)	24 V	5 V, 12 V	—	M9NV	M9N	●	●	●	○	○	Relay, PLC		
				3-wire (PNP)				M9PV	M9P	●	●	●	○	○			
				2-wire				M9BV	M9B	●	●	●	○	○			
	3-wire (NPN)			M9NWV				M9NW	●	●	●	○	○	IC circuit			
	3-wire (PNP)			M9PWV				M9PW	●	●	●	○	○				
	2-wire			M9BKV				M9B	●	●	●	○	○				
Reed auto switch	—	Grommet	Yes	3-wire (NPN equiv.)	24 V	12 V	100 V 100 V or less	A96V	A96	●	—	●	—	—	Relay, PLC		
				2-wire				A93V ^{*2}	A93	●	●	●	●	—		—	
				—				A90V	A90	●	—	●	—	—		—	—
				—				—	—	—	—	—	—	—		—	—
				—				—	—	—	—	—	—	—		—	—
				—				—	—	—	—	—	—	—		—	—

*1 Water resistant type auto switches can be mounted on the above models, but in such case SMC cannot guarantee water resistance.

Consult with SMC regarding water resistant types with the above model numbers.

*2 1 m type lead wire is only applicable to D-A93.

* Lead wire length symbols: 0.5 m Nil (Example) M9NV
1 m M (Example) M9NW
3 m L (Example) M9NWL
5 m Z (Example) M9NWZ

* Solid state auto switches marked "○" are produced upon receipt of order.

* Refer to page 631 for applicable auto switches other than listed above.

* Refer to pages 1192 and 1193 for details of auto switches with a pre-wired connector.

* Auto switches are shipped together (not assembled).

Double Power Cylinder/ Without Non-rotating Mechanism **MGZR Series**



Made to Order

Made to Order: Individual Specifications
(Refer to page 632 for details.)

Symbol	Specifications
-X1248	Rod end female thread: 4 pcs.

Specifications

Bore size (mm)		20	25	32	40	50	63	80
Action		Double acting, Single rod						
Fluid		Air						
Proof pressure		1.5 MPa						
Max. operating pressure		1.0 MPa						
Min. operating pressure		Standard stroke: 0.08 MPa						
		Long stroke: 0.12 MPa						
Ambient and fluid temperature		Without auto switch: -10° to 70°C (With no freezing)						
		With auto switch: -10° to 60°C (With no freezing)						
Lubrication		Non-lube						
Piston speed	OUT	50 to 700 mm/s						
	IN	50 to 350 mm/s		50 to 450 mm/s				
Stroke length tolerance		Up to 250 ^{+1.0} ₀ , 251 to 1000 ^{+1.4} ₀						
Cushion		Rubber bumper						
Mounting		Basic type, Transaxial foot type, Rod flange type Head flange type, Double clevis type						

Standard Stroke

Bore sizes (mm)	Standard strokes (mm)	Long strokes (mm)
20, 25	75, 100, 125, 150, 175 200, 250, 300	350, 400, 450, 500 600, 700, 800
32, 40, 50 63, 80	75, 100, 125, 150, 175 200, 250, 300	350, 400, 450, 500, 600 700, 800, 900, 1000

Intermediate strokes and strokes shorter than 75mm are also available.

Weight

Bore sizes (mm)		20	25	32	40	50	63	80	(kg)
Standard weight	Basic type	0.48	0.70	1.09	1.91	3.03	4.83	8.85	
	Foot type	0.63	0.86	1.34	2.39	3.92	6.08	10.61	
	Flange type	0.59	0.83	1.32	2.34	3.79	5.83	9.92	
	Double clevis type	0.58	0.83	1.32	2.19	3.47	5.62	10.66	
Weight per each 50 mm of stroke	All mounting brackets	0.19	0.22	0.29	0.39	0.59	0.78	1.21	

Theoretical Output

Model	Bore size (mm)	Rod size (mm)	Operating direction	Piston area (mm ²)	Operating pressure (MPa)									
					0.2	0.3	0.4	0.5	0.6	0.7	0.8	0.9	1.0	
MGZ20	20 x 25	10	OUT	726	145	218	290	363	436	508	581	653	726	
			IN	236	47	71	94	118	141	165	189	212	236	
MGZ25	25 x 30	12	OUT	1085	217	326	434	543	651	760	868	977	1085	
			IN	378	76	113	151	189	227	265	302	340	378	
MGZ32	36 x 32	16	OUT	1621	324	486	648	811	973	1135	1297	1459	1621	
			IN	603	121	181	241	302	362	422	482	543	603	
MGZ40	45 x 40	20	OUT	2533	507	760	1013	1267	1520	1773	2026	2280	2533	
			IN	942	188	283	377	471	565	659	754	848	942	
MGZ50	55 x 50	25	OUT	3848	770	1154	1539	1924	2309	2694	3078	3463	3848	
			IN	1473	295	442	589	737	884	1031	1178	1326	1473	
MGZ63	68 x 63	32	OUT	5945	1189	1784	2378	2973	3567	4162	4756	5351	5945	
			IN	2313	463	694	925	1157	1388	1619	1850	2082	2313	
MGZ80	87 x 80	40	OUT	9715	1943	2915	3886	4858	5829	6801	7772	8744	9715	
			IN	3770	754	1131	1508	1885	2262	2639	3016	3393	3770	

Mounting Bracket Part No.

Bore size (mm)	20	25	32	40	50	63	80
Foot	MGZ-L02	MGZ-L25	MGZ-L03	MGZ-L04	MGZ-L05	MGZ-L06	MGZ-L08
Flange	MGZ-F02	MGZ-F25	MGZ-F03	MGZ-F04	MGZ-F05	MGZ-F06	MGZ-F08
Double clevis	MGZ-D02	MGZ-D25	MGZ-D03	MGZ-D04	MGZ-D05	MGZ-D06	MGZ-D08

Note) Accessories for each mounting bracket are as follows.

Foot, Flange: Body mounting bolts, Double clevis: Body mounting bolt, clevis pins, cotter pins.

MGJ

JMGF

MGP

MGPW

MGQ

MGG

MGC

MGF

MGZ

MGT

D-□

-X□

MGZR Series

Construction: MGZR

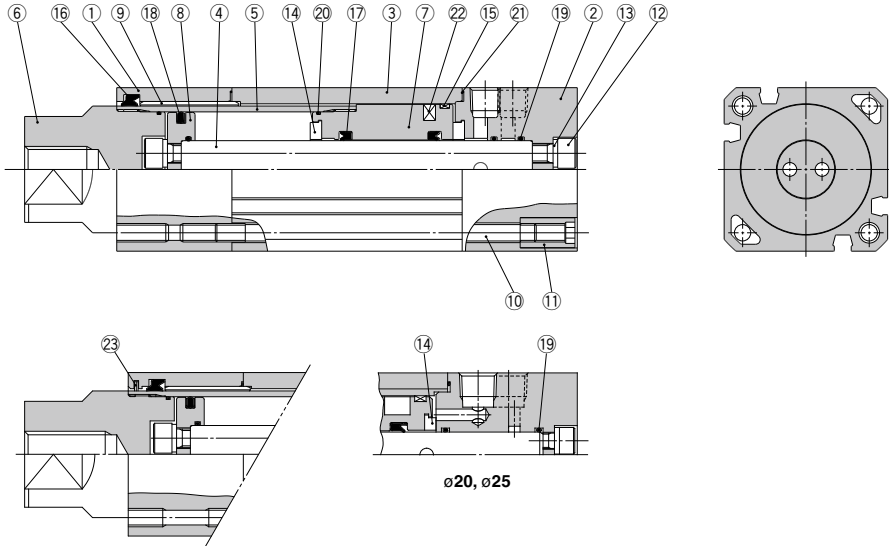

Component Parts

No.	Description	Material	Note
1	Rod cover	Aluminum alloy	Clear anodized
2	Head cover	Aluminum alloy	Clear anodized
3	Cylinder tube	Aluminum alloy	Hard anodized
4	Piston rod	Aluminum alloy	Hard anodized
5	Tube rod	Carbon steel	Hard chromium electroplated
6	Tube rod cover	Carbon steel	Electroless nickel plated
7	Piston	Aluminum alloy	Chromated
8	Stationary piston	Aluminum alloy	Chromated
9	Bushing		
10	Tie-rod	Carbon steel	Corrosion resistant chromated
11	Tie-rod nut	Carbon steel	Nickel plated
12	Hexagon socket head screw	Chrome molybdenum steel	Zinc trivalent chromated

No.	Description	Material	Note
13	Spring washer	Steel wire	Zinc trivalent chromated
14	Bumper	Urethane rubber	
15	Wear ring	Resin	
16*	Rod seal A	NBR	
17	Rod seal B	NBR	
18	Piston seal	NBR	
19	Piston gasket	NBR	
20	Tube rod gasket	NBR	
21*	Cylinder tube gasket	NBR	
22	Magnet	—	
23	Coil scraper	Metal	

Replacement Parts/Seal Kit

Bore size (mm)	Kit no.	Contents
20	MGZ20-PS	Items 16 and 21 from the above chart
25	MGZ25-PS	
32	MGZ32-PS	
40	MGZ40-PS	
50	MGZ50-PS	
63	MGZ63-PS	
80	MGZ80-PS	

* Seal kits consist of items 16 and 21, and can be ordered by using the seal kit number corresponding to each bore size.

* Seal kit includes a grease pack (ø20 to ø50: 10 g, ø63, 80: 20 g).

Order with the following part number when only the grease pack is needed.
Grease pack part no.: GR-S-010 (10 g), GR-S-020 (20 g)

Dimensions

Basic type

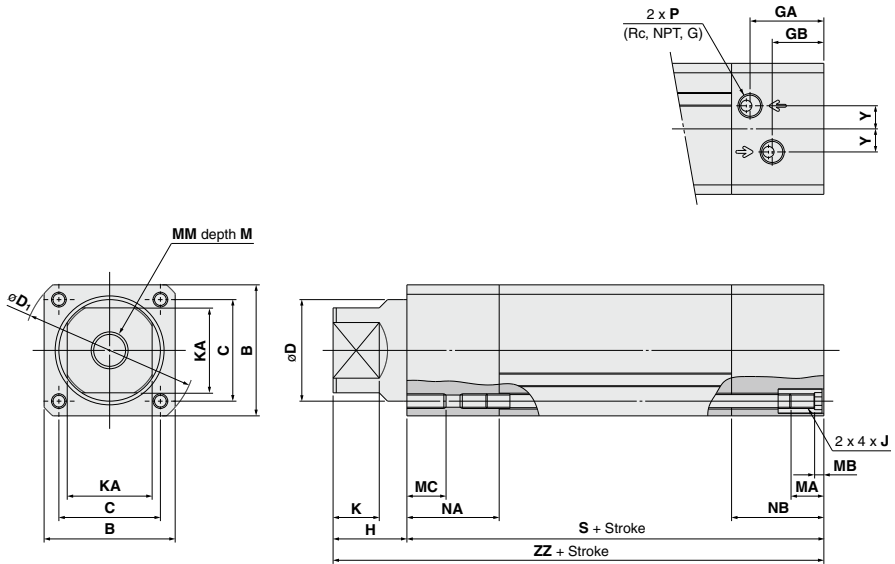

Bore size (mm)	Stroke range	B	C	D	KA	GA	GB	H	D ₁	J	K	M	MA	MB	MC	MM	NA	NB	P	S	Y	ZZ
20	Up to 800	39	29	25	21	16	12.5	20	51	M5 x 0.8	11	17	11	4	10	M8 x 1.25	19	21	M5 x 0.8	86	5	106
25	Up to 800	43	33	30	24	26	18	21	57	M5 x 0.8	12	17	11	4	10	M8 x 1.25	26	34	1/8	107	6.5	128
32	Up to 1000	49	38	36	30	28.5	19.5	35	66	M6 x 1	22	22	16	4	12	M10 x 1.5	37	1/8	120	8.5	155	
40	Up to 1000	59	46	45	36	34.5	23.5	40	78	M6 x 1	25	30	16	4	12	M16 x 2	44	1/4	138	9.5	178	
50	Up to 1000	71	55	55	46	40	28	45	92	M8 x 1.25	25	35	16	5	15	M20 x 2.5	50	1/4	150	12.5	195	
63	Up to 1000	82	66	68	53	46.5	34.5	50	110	M8 x 1.25	25	35	16	5	15	M20 x 2.5	56	1/4	171	15	221	
80	Up to 1000	106	86	87	65	54	36	50	144	M12 x 1.75	25	38	20	6	23	M22 x 2.5	66	3/8	198	20	248	

MGJ

JMGP

MGP

MGPW

MGQ

MGG

MGC

MGF

MGZ

MGT

D-□

-X□

MGZR Series

Dimensions: With Mounting Bracket

Transaxial foot type: (L)

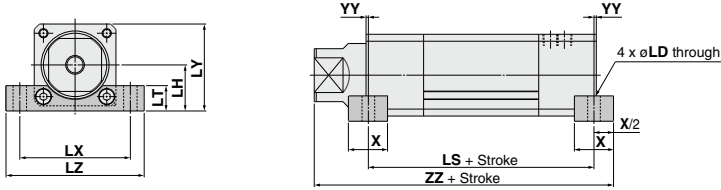

Bore size (mm)	Stroke range	X	YY	LD	LH	LT	LX	LY	LZ	LS	ZZ
20	Up to 800	16	0	6.6	22	13	58	41.5	72	86	114
25	Up to 800	16	0	6.6	24	14	62	45.5	75	107	136
32	Up to 1000	22	0	9	27.5	16	70	52	88	120	166
40	Up to 1000	24	0	9	34	19	80	63.5	100	138	190
50	Up to 1000	32	1	11	40	22	96	75.5	120	148	210
63	Up to 1000	36	3	13	47	24	110	88	140	165	236
80	Up to 1000	40	3	17	59	30	146	112	180	192	265

Rod flange type: (F)

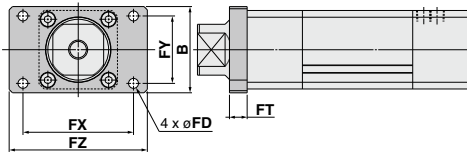

Head flange type: (G)

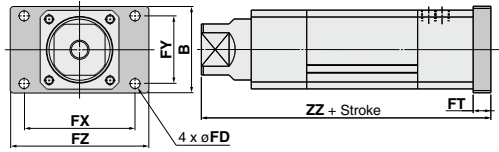

Bore size (mm)	Stroke range	B	FD	FT	FX	FY	FZ
20	Up to 800	44	5.5	8	50	34	60
25	Up to 800	48	6.6	8	57	36	70
32	Up to 1000	60	9	12	64	46	78
40	Up to 1000	74	9	12	80	58	100
50	Up to 1000	78	9	16	100	61	125
63	Up to 1000	100	12	16	112	75	138
80	Up to 1000	120	14	16	132	95	155

Bore size (mm)	Stroke range	B	FD	FT	FX	FY	FZ	ZZ
20	Up to 800	44	5.5	8	50	34	60	114
25	Up to 800	48	6.6	8	57	36	70	136
32	Up to 1000	60	9	12	64	46	78	167
40	Up to 1000	74	9	12	80	58	100	190
50	Up to 1000	78	9	16	100	61	125	211
63	Up to 1000	100	12	16	112	75	138	237
80	Up to 1000	120	14	16	132	95	155	264

Double clevis type: (D)

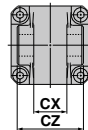
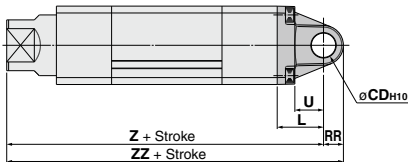

* A clevis pin and 2 cotter pins are included.

Bore size (mm)	Stroke range	L	RR	U	CDH10	CX ^{+0.3} _{-0.1}	CZ	Z	ZZ
20	Up to 250	23	8.5	14	10	14	28	129	137.5
25	Up to 350	23	11	14	10	14	28	151	162
32	Up to 600	30	12	17	14	20	40	185	197
40	Up to 600	30	15	17	14	20	40	208	223
50	Up to 700	42	18	26	22	30	60	237	255
63	Up to 900	42	23	26	22	30	60	263	286
80	Up to 900	50	28	30	25	32	64	298	326

Double Clevis Bracket

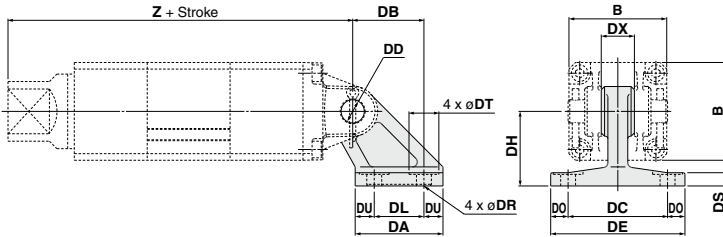

Model	Bore size (mm)	B	DA	DB	DC	DD _{H10}	DE	DH	DL	DO	DR	DS	DT	DU	DX	Z
MB-B03	20	39	42	32	44	10 ^{+0.058}	62	33	22	9	6.6	7	15	10	14	129
	25	43	42	32	44	10 ^{+0.058}	62	33	22	9	6.6	7	15	10	14	151
MB-B05	32	49	53	43	60	14 ^{+0.070}	81	45	30	10.5	9	8	18	11.5	20	185
	40	59	53	43	60	14 ^{+0.070}	81	45	30	10.5	9	8	18	11.5	20	208
MB-B08	50	71	73	64	86	22 ^{+0.084}	111	65	45	12.5	11	10	22	14	30	237
	63	82	73	64	86	22 ^{+0.084}	111	65	45	12.5	11	10	22	14	30	263
MB-B12	80	106	90	78	110	25 ^{+0.084}	136	75	60	13	13.5	14	24	15	32	298

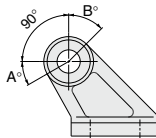

Rotation

Bore size (mm)	A°	B°	A° + B° + 90°
20	35	50	175
25	30	50	170
32, 40	30	50	170
50, 63	35	50	175
80	30	35	155

Clevis Pin

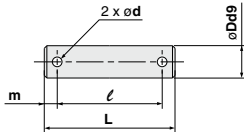

Model	Bore size (mm)	Dd ₉	L	ℓ	m	d (Drill through)	Coater pin ^{Note}
CD-M03	20, 25	10 ^{-0.040} -0.016	44	36	4	3	ø3 x 18 ℓ
CD-M05	32, 40	14 ^{-0.050} -0.023	60	51	4.5	4	ø4 x 25 ℓ
CD-M08	50, 63	22 ^{-0.117} -0.062	82	72	5	4	ø4 x 35 ℓ
CDP-7A	80	25 ^{-0.085} -0.117	88	78	5	4	ø4 x 36 ℓ

Note) Coater pins and flat washers are included.

Floating Joint

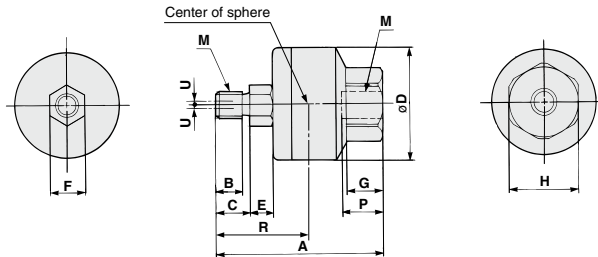

Applicable bore size	Model	M		A	B	C	D	E	F	G	H	Center of sphere R	Max. screw-in depth P	Allowable eccentricity U	Max. operating tension and compression N		Weight (kg)
		Nominal size	Pitch												Compression	Tension	
20, 25	JB40-8-125	8	1.25	51	8.5	11	31	6	11	11	22	29	13	0.75	6000	1300	0.15
32	JB63-10-150	10	1.5	62.5	10	13	41	7.5	14	13.5	27	35.5	15	1	11000	3100	0.29
40	JB80-16-200	16	2	80.5	16	20	50	9.5	19	16	32	47.5	18	1.25	18000	5000	0.56
50, 63	JB100-20-250	20	2.5	101	21	26	59.5	11.5	24	20	41	59	24	2	28000	7900	1.04
80	JB140-22-250	22	2.5	129	18	22	79	14	30	22	46	71.5	38	2.5	54000	15300	2.6

Auto Switch Mounting

Minimum Stroke for Mounting

Model		No. of auto switches	(mm)						
			ø20	ø25	ø32	ø40	ø50	ø63	ø80
D-A9□	2 pcs. (Same surface)			50			50		50
	2 pcs. (Different surfaces)			15			15		15
	1 pc.			15			15		10
D-A9□V	2 pcs. (Same surface)			25			25		25
	2 pcs. (Different surfaces)			10			10		10
	1 pc.			5			5		5
D-M9□V	2 pcs. (Same surface)			30			30		30
	2 pcs. (Different surfaces)			10			10		10
	1 pc.			5			5		5
D-M9□ D-M9□W	2 pcs. (Same surface)			55			55		55
	2 pcs. (Different surfaces)			15			15		15
	1 pc.			15			15		10
D-M9□WV	2 pcs. (Same surface)			30			30		30
	2 pcs. (Different surfaces)			15			15		15
	1 pc.			10			10		10
D-M9□A	2 pcs. (Same surface)			60			60		60
	2 pcs. (Different surfaces)		20	15			15		15
	1 pc.			15			15		10
D-M9□AV	2 pcs. (Same surface)			35			35		35
	2 pcs. (Different surfaces)			15			15		15
	1 pc.			10			10		10
D-Z7□/Z80	2 pcs. (Same surface)			—			60		70
	2 pcs. (Different surfaces)			—			20		20
	1 pc.			—			20		20
D-Y59□/Y69□ D-Y7P/Y7PV	2 pcs. (Same surface)			—			60		65
	2 pcs. (Different surfaces)			—			20		20
	1 pc.			—			20		20
D-Y7□W D-Y7□WV	2 pcs. (Same surface)			—			70		65
	2 pcs. (Different surfaces)			—			25		20
	1 pc.			—			25		20
D-Y7BA	2 pcs. (Same surface)			—			70		75
	2 pcs. (Different surfaces)			—			25		20
	1 pc.			—			25		20

Auto Switch Proper Mounting Position (Detection at Stroke End) and Its Mounting Height

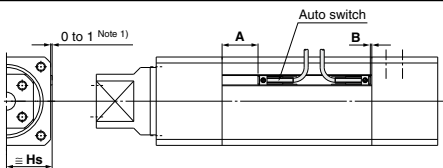

Auto Switch Proper Mounting Position

Auto switch model	(mm)					
	D-A9□ D-A9□V		D-M9□/M9□V D-M9□W/M9□WV D-M9□A/M9□AV		D-Z7□/Z80 D-Y59□/Y69□ D-Y7P/Y7PV D-Y7□W/Y7□WV D-Y7BA	
Bore size	A	B	A	B	A	B
20	24	3	28	7	—	—
25	24	3	28	7	—	—
32	22	4	26	8	—	—
40	24.5	2.5	28.5	6.5	23	0
50	24.5	2.5	28.5	6.5	23	0
63	33.5	2.5	37.5	6.5	32	0
80	38	5	42	9	37	4

Note) Adjust the auto switch after confirming the operating conditions in the actual setting.

Auto Switch Mounting Height

Auto switch model	(mm)	
	D-A9□V Note 2) D-Y69□ D-Y7PV D-Y7□WV	
Bore size	Hs	Hs
20	25	28
25	27	30
32	30	33
40	28.5	31.5
50	38.5	41.5
63	44	47
80	56	59

Note 1) The above figures are when the in-line electrical entry type D-A9□/M9□/M9□W/M9□A/Z□/Z80/Y59□/Y7P/Y7□W/Y7BA auto switches are mounted.

Note 2) Z□/Z80/Y59□/Y7P/Y7□W/Y7BA cannot be mounted on ø20 to ø32.

Operating Range

Auto switch model	Bore size (mm)						
	20	25	32	40	50	63	80
D-A9□/A9□V	8	9.5	8	8	8.5	9.5	9.5
D-M9□/M9□V D-M9□W/M9□WV D-M9□A/M9□AV	4.5	4.5	5	5	5	6.5	6
D-Z7□/Z80	—	—	—	10	10	11	13
D-Y59□/Y69□ D-Y7P/Y7PV D-Y7□W/Y7□WV D-Y7BA	—	—	—	6	5	6	8

* Hysteresis specifications are given as a guide, it is not a guaranteed range.
(Tolerance ±30%)
Hysteresis may fluctuate due to the operating environment.

Auto Switch Mounting Bracket: Part No.

Auto switch model	Bore size	
	ø20 to ø32	ø40 to ø80
D-A9□/A9□V D-M9□/M9□V D-M9□W/M9□WV D-M9□A/M9□AV	BMY3-016	Note) ① BMP1-032 ② BMG2-012
D-Z7□/Z80 D-Y5□/Y7P D-Y7□W D-Y6□/Y7PV D-Y7□WV D-Y7BA	—	① BMP1-032

Note) Two kinds of auto switch mounting brackets are used as a set.

D-A9□V/M9□(V)/M9□W(V)/M9□A(V) with bore sizes of ø40 to ø80.

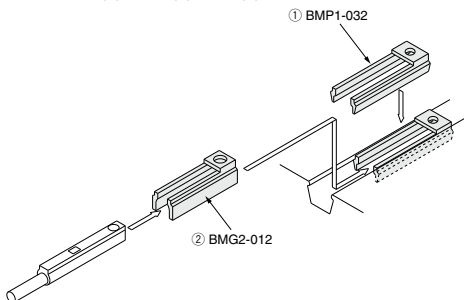

Besides the models listed in How to Order, the following auto switches are applicable.
Refer to pages 1119 to 1245 for the detailed specifications.

Auto switch type	Model	Electrical entry (Fetching direction)	Features	Applicable bore size
Reed	D-Z73, Z76	Grommet (In-line)	—	ø40 to ø80
	D-Z80		Without indicator light	
Solid state	D-Y69A, Y69B, Y7PV	Grommet (Perpendicular)	—	
	D-Y7NWV, Y7PWV, Y7BWW		Diagnostic indication (2-color indicator)	
	D-Y59A, Y59B, Y7P	Grommet (In-line)	—	
	D-Y7NW, Y7PW, Y7BW		Diagnostic indication (2-color indicator)	
	D-Y7BA		Water resistant (2-color indicator)	

* For solid state auto switches, auto switches with a pre-wired connector are also available. Refer to pages 1192 and 1193 for details.
* Normally closed (NC = b contact) solid state auto switches (D-F9G/F9H/Y7G/Y7H types) are also available. Refer to pages 1137 and 1139 for details.

MGJ

JMGP

MGP

MGPW

MGQ

MGG

MGC

MGF

MGZ

MGT

D-□

-X□

MGZ/MGZR Series

Made to Order: Individual Specifications

Please contact SMC for detailed dimensions, specifications and lead times.



1 Rod End One Female Threaded Hole **-X1247**

Symbol

The tube rod cover of MGZR is the same as that mounted on MGZ.

MGZ [Refer to How to Order](#) - X1247

* The rod end shape and dimensions are identical to those of MGZR.

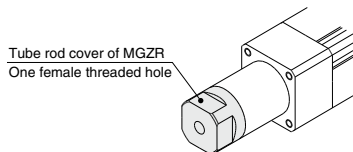

2 Rod End Four Female Threaded Holes **-X1248**

Symbol

The tube rod cover of MGZ is the same as that mounted on MGZR.

MGZR [Refer to How to Order](#) - X1248

* The rod end shape and dimensions are identical to those of MGZ.

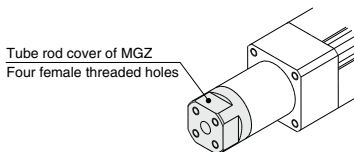



MGZ/MGZR Series Specific Product Precautions 1

Be sure to read this before handling the products.
Refer to back page 50 for Safety Instructions and pages 3 to 12 for Actuator and Auto Switch Precautions.

Selection

⚠ Caution

1. Operate load within the range of the operating limits.

In accordance with the model selection procedure, operate within the operating limits of load weight, maximum speed, center of gravity position and allowable rotating torque. Operation beyond the operating limits can cause wear of the bearings and loosening of connections, leading to damage of machinery.

2. Compared to regular cylinders, at least twice the time is required for movement to begin in the retracting direction.

Cylinders featured in this catalog are filled with twice the amount of air at the extending compared to regular cylinders, therefore a longer time is required to exhaust the air before movement in the retracting direction begins.

3. Construct equipment so that reactive forces such as external stoppers and pressing are applied to the cylinder's central axis.

Design the external stopper or die so that when a cylinder stops before the stroke end on a stopper or press, the reactive force is applied to the cylinder's central axis. Off-center operation can cause wear of the bearings and loosening connections, leading to damage of machinery.

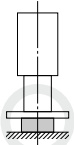

Correct

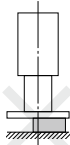

Incorrect

4. Under horizontal or downward operating conditions, lurch prevention measures may be required for the cylinder's extending operation.

Since the output force of the cylinders featured in this catalog in the extending direction is at least double that in the retracting direction, start-up operation for extension may exceed the control speed of the speed controller. In this case, provide a lurch prevention circuit within the pneumatic circuitry.

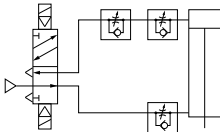

5. Do not over throttle the meter-in speed controller of the lurch prevention circuit.

Throttling the meter-in speed controller will make the start-up time for output in the extending direction longer.

Operation

⚠ Caution

1. Do not apply more than the allowable rotating torque to the piston rod (for MGZ series: with non-rotating mechanism).

If more than the allowable rotating torque is applied, the slide keys for non-rotation will be deformed and non-rotating accuracy will be lost. This may cause damage to machinery.

Mounting

⚠ Caution

1. When mounting the cylinder, use mounting bolts of a suitable length, and tighten them properly within the specified range of tightening torque.

Particularly in case of frequent operation or much vibration, empty measures to prevent loosening of the bolts, such as the application of a thread locker.

Model	Bolt	Proper tightening torque N·m	L ₁	L ₂
MGZ/MGZR20	M5 x 0.8	2.5 to 3.1	10	11
MGZ/MGZR25	M5 x 0.8	2.5 to 3.1	10	11
MGZ/MGZR32	M6 x 1	4.1 to 6.4	12	16
MGZ/MGZR40	M6 x 1	4.1 to 6.4	12	16
MGZ/MGZR50	M8 x 1.25	8.8 to 13.8	15	16
MGZ/MGZR63	M8 x 1.25	8.8 to 13.8	15	16
MGZ/MGZR80	M12 x 1.75	30.4 to 47.5	23	20

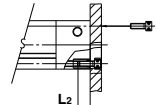
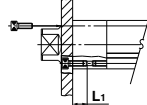

2. Do not gouge or scratch the mounting surfaces of the rod cover and head cover.

Evenness of mounting surfaces will be degraded, causing increased operating resistance and wear of the bearings etc.

3. Mounting of workpiece on the rod end

When screwing bolts into the threads of the table surface at the end of the piston rod, be sure the piston rod is fully retracted and use the wrench flats to hold the rod. Tighten the bolts in such a way that the tightening torque is not applied to the non-rotation slide keys. (for MGZ series: with non-rotating mechanism).

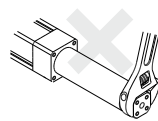
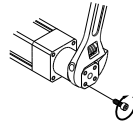

4. Allowable angle displacement of □E to □B is $\pm 1.5^\circ$. (for MGZ series: with non-rotating mechanism)

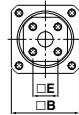

Applicable Floating Joint

⚠ Caution

1. When using a floating joint at the end of the tube rod, use the model specified in the table below. (for MGZR series: without non-rotating mechanism)

Model	Applicable floating joint
MGZR20	JB40-8-125
MGZR25	JB63-10-150
MGZR32	JB80-16-200
MGZR40	JB100-20-250
MGZR50	JB140-22-250
MGZR63	
MGZR80	

MGJ

JMGF

MGP

MGPW

MGQ

MGG

MGC

MGF

MGZ

MGT

D-□

-X□



MGZ/MGZR Series Specific Product Precautions 2

Be sure to read this before handling the products.
Refer to back page 50 for Safety Instructions and pages 3 to 12 for Actuator and Auto Switch Precautions.

End Lock Precautions

Use the Recommended Pneumatic Circuit.

⚠ Caution

This is necessary for proper operation and release of the lock.

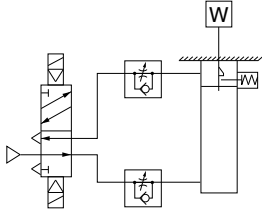

1. Do not use 3-position solenoid valve.

Avoid use in combination with 3-position solenoid valves (especially closed center metal seal types). If pressure is trapped in the port on the retracting side the cylinder cannot be locked. Furthermore, even after being locked, the lock may disengage after some time, due to air leaking from the solenoid valve and entering the cylinder.

2. Back pressure is required when releasing the lock.

Before starting operation, be sure to control the system so that air is supplied to the extending side as shown in the figure above. Otherwise, there is a possibility that the lock may not be released. (Refer to the Releasing the Lock section.)

3. Release the lock when mounting or adjusting the cylinder.

The lock unit may be damaged if mounting or other work is performed when the cylinder is locked.

4. Operate with a load factor of 50% or less.

If the load ratio exceeds 50%, this may cause problems such as failure of the lock to release or damage to the lock unit.

5. Do not operate multiple synchronized cylinders.

Avoid applications in which two or more end lock cylinders are synchronized to move one work piece, as one of the cylinder locks may not be able to be released when required.

6. Use a speed controller with meter-out control.

It may not be possible to release the lock with meter-in control.

7. Be sure to operate completely to the cylinder stroke end on the extending side.

If the cylinder piston does not reach the end of the stroke, locking and unlocking may not be possible.

8. Adjust the auto switch's position so that it operates for movement to both the stroke end and backlash (2 mm) positions.

When a 2-color indicator switch is adjusted for green indication at the stroke end, it may change to red after the backlash return, but this is not abnormal.

Operating Pressure

⚠ Caution

Apply air pressure of at least 0.20 MPa to the port on the retracting side. This is necessary to release the lock.

Exhaust Speed

⚠ Caution

Locking will occur automatically if the pressure applied to the port on the retracting side falls down to 0.05 MPa or less. In cases where the piping on the retracting side is long and thin, or the speed controller is some distance away from the cylinder port, the exhaust speed will be reduced and the lock may not engage right away. Furthermore, clogging of a silencer mounted on the exhaust port of the solenoid valve can produce the same result.

Releasing the Lock

⚠ Warning

Before releasing the lock, be sure to supply air to the extending side, so that there is no load applied to the lock mechanism when it is released. (Refer to the recommended pneumatic circuit.) If the lock is released when the port on the extending side is in an exhaust state and with a load applied to the lock mechanism, the lock mechanism may be subjected to an excessive force and be damaged. Also, remember that sudden erratic movement of the tube rod is very dangerous.

Manual Release

⚠ Caution

Non-locking type manual release

Insert the accessory bolt from the top of the rubber cap (it is not necessary to remove the rubber cap), and after screw it into the lock piston, pull it to release the lock. If you stop pulling the bolt, the lock will return to an operational state. Thread sizes, pulling force and stroke are shown below.

Bore size (mm)	Screw size	Pulling force (N)	Stroke (mm)
40, 50, 63	M3 x 0.5 x 30 L or more	10	3

* Remove the bolt for normal operation, otherwise it can cause lock malfunction or faulty release.

