

Series 10-/11-**CA2** 21-/22-

ø40, ø50, ø63 Air Cylinder

RoHS

How to Order

Clean series

10	Relief type
11	Vacuum suction type

Mounting

B	Basic
L	Axial foot
F	Rod flange
G	Head flange

Bore size (mm)



Port thread type

Nil	Rc
TN	NPT
TF	G

10 - C D A 2 B 40 [] - 150 - Y59B []

21 - C D A 2 B 40 [] - 150 - Y59B []

Built-in magnet

Nil	No
D	With auto switch (Built-in magnet)

Copper, fluorine and silicone-free + Low particle generation

21	Relief type
22	Vacuum suction type

Cylinder stroke (mm)

Auto switch

Reed switch	Z7□, A54/A59W
Solid state	J51/F5□, Y5□/Y7□

* The minimum stroke for auto switch mounting, operating range and auto switch mounting brackets/part no. are the same as standard products.

Number of auto switches

Nil	2 pcs.
S	1 pc.
n	"n" pcs.

Model

Model		Bore size (mm)	Port size	Lubrication	Action	Standard stroke (mm)	Auto switch mounting	Cushion
Relief type	10-/21-CA2□40	40	1/4	Non-lube	Double acting, single rod	50, 75, 100, 125,	Available	Air cushion
	10-/21-CA2□50	50	3/8					
	10-/21-CA2□63	63						
Vacuum suction type	11-/22-CA2□40	40	1/4					
	11-/22-CA2□50	50	3/8			150, 200, 250, 300, 350, 400, 450, 500		
	11-/22-CA2□63	63						

(Note) Please consult with SMC for long strokes including packaging method (normal packaging according to the stroke).

Specifications

Item	Bore size (mm)
	40/50/63
Proof pressure	1.5 MPa
Maximum operating pressure	1.0 MPa
Minimum operating pressure	0.05 MPa
Ambient and fluid temperature	Without auto switch: -10°C to 70°C With auto switch: -10°C to 60°C (No freezing)
Piston speed	50 to 400 mm/s
Stroke length tolerance	Up to 250 ^{+0.1} mm, 251 to 1000 ^{+0.1} mm
Mounting	Basic/Axial foot/Rod flange/Head flange
Grease	10-/11-: Fluorine grease 21-/22-: Lithium soap based grease
Cleanliness class (ISO class)	10-: Class 4, 21-: Class 5
	11-/22-: Class 3

Suction Flow Rate of Vacuum Suction Type (Reference values)

Bore size	Suction flow rate L/min (ANR)
40	10
50/63	20

Applicable Auto Switch (Refer to the WEB catalog for further information on auto switches.)

Type	Special function	Electrical entry	Indicator light	Wiring (Output)	Load voltage		Auto switch model	Lead wire length (m) [*]			Pre-wire connector	Applicable load		
					DC	AC		0.5 (Nil)	3 (L)	5 (Z)		IC circuit	Relay, PLC	
Reed auto switch	—	Grommet	Yes	3-wire (NPN equivalent)	—	5 V	—	Z76	●	●	—	—	IC circuit	—
				2-wire	24 V	—	100 V, 200 V	Z73 A54 A59W	●	●	●	—	—	—
Solid state auto switch	—	Grommet	Yes	3-wire (NPN)	24 V	5 V, 12 V	—	Y59A	●	●	○	○	IC circuit	Relay, PLC
				3-wire (PNP)				Y7P	●	●	○	○	IC circuit	
	2-wire	—	100 V, 200 V	J51	●	●	○	○	—					
	12 V			Y59B	●	●	○	○	—					
	Diagnostic indication (2-color indication)	Grommet	Yes	3-wire (NPN)	24 V	5 V, 12 V	—	Y7NW	●	●	○	○	IC circuit	
				3-wire (PNP)				Y7PW	●	●	○	○	IC circuit	
	Water resistant (2-color indication)	Grommet	Yes	2-wire	—	12 V	—	Y7BW	●	●	○	○	—	
				4-wire (NPN)				Y7BA	●	●	○	○	IC circuit	
With diagnostic output (2-color indication)	—	—	—	—	—	—	F59F	●	●	○	○	IC circuit		

* Lead wire length symbols: 0.5 m.....Nil (Example) A54
 3 m.....L (Example) A54L
 5 m.....Z (Example) A54Z

* Solid state switches marked with "○" are produced upon receipt of order.

Refer to page 889 for the applicable auto switch list.

Proper Auto Switch Mounting Position (Detection at Stroke End) and Its Mounting Height

- D-Z7□
- D-Y59□/Y69□/Y7P/Y7PV
- D-Y7□W/Y7□WV
- D-Y7BAL

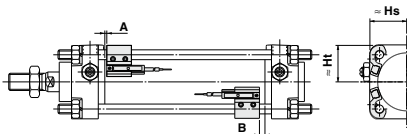

- D-A5□
- D-A59W

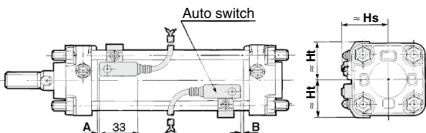

- D-F5□/J5□

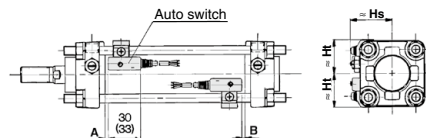

Values inside () are for D-F5LF.

Proper Auto Switch Mounting Position (mm)

Auto switch model	D-Z7□ D-Y59□ D-Y7P D-Y7□W D-Y7BAL		D-A54		D-A59W		D-J51 D-F59F	
	A	B	A	B	A	B	A	B
Bore size (mm) 40	3.5	1.5	0	0	4	2	7	4
50	3.5	1.5	0	0	4	2	6.5	4.5
63	6	5	2.5	1.5	6.5	5.5	12.5	8

Auto Switch Mounting Height (mm)

Auto switch model	D-Z7□ D-Y59□ D-Y7P D-Y7BAL D-Y7□W		D-A54 D-A59W		D-J51 D-F59F	
	Hs	Ht	Hs	Ht	Hs	Ht
Bore size (mm) 40	30	30	38.5	31.5	38	31.5
50	34	34	42	35.5	42	35.5
63	41	41	46.5	43	47	43

Note) The above values should be used as a guide for detection at stroke end. When actually mounting the auto switch, adjust the position after confirming the operating conditions of the auto switch.

Basic (B): 10-CA2B, 21-CA2B

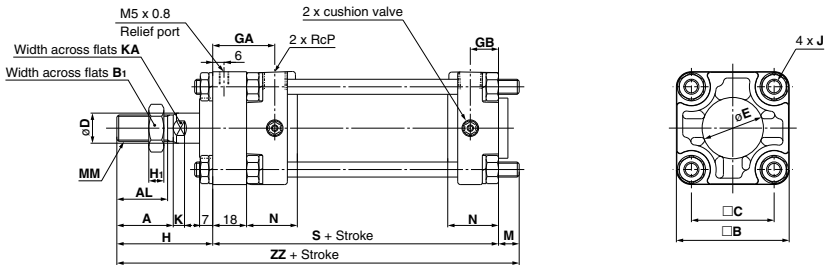

Symbol	Stroke range	A	AL	B	B ₁	C	D	E	GA	GB	H	H ₁	J	K	KA	M	MM	N	P	S	ZZ
40	Up to 1000	30	27	60	22	44	16	32	33	15	51	8	M8 x 1.25	6	14	11	M14 x 1.5	27	1/4	102	164
50	Up to 1000	35	32	70	27	52	20	40	35	17	58	11	M8 x 1.25	7	18	11	M18 x 1.5	30	3/8	108	177
63	Up to 1000	35	32	85	27	64	20	40	35	17	58	11	M10 x 1.25	7	18	14	M18 x 1.5	31	3/8	116	188

Axial Foot (L): 10-CA2L, 21-CA2L

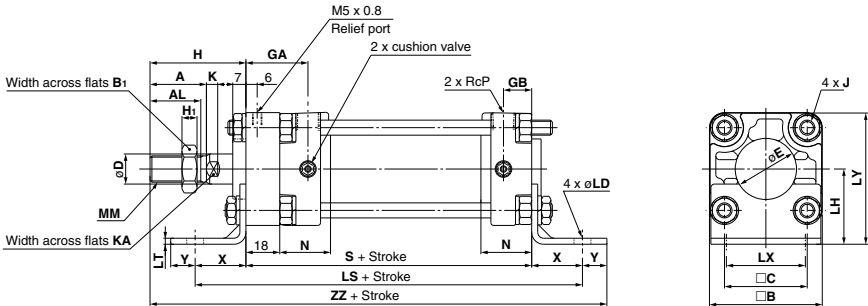

Symbol	Stroke range	A	AL	B	B ₁	C	D	E	GA	GB	H	H ₁	J	K	KAL	LD	LH	LS	LT	LX	LY	MM	N	P	S	X	Y	ZZ
40	Up to 1000	30	27	60	22	44	16	32	33	15	51	8	M8 x 1.25	6	14	9	40	156	3.2	42	70	M14 x 1.5	27	1/4	102	27	13	193
50	Up to 1000	35	32	70	27	52	20	40	35	17	58	11	M8 x 1.25	7	18	9	45	162	3.2	50	80	M18 x 1.5	30	3/8	108	27	13	206
63	Up to 1000	35	32	85	27	64	20	40	35	17	58	11	M10 x 1.25	7	18	11.5	50	184	3.2	59	93	M18 x 1.5	31	3/8	116	34	16	224

Directional Control Valves
Air Cylinders
Rotary Actuators
Air Grippers
Air Preparation Equipment
Modular F. R.
Pressure Control Equipment
Fittings & Tubing
Flow Control Equipment
Pressure Switches/ Pressure Sensors

Rod Flange (F): 10-CA2F, 21-CA2F

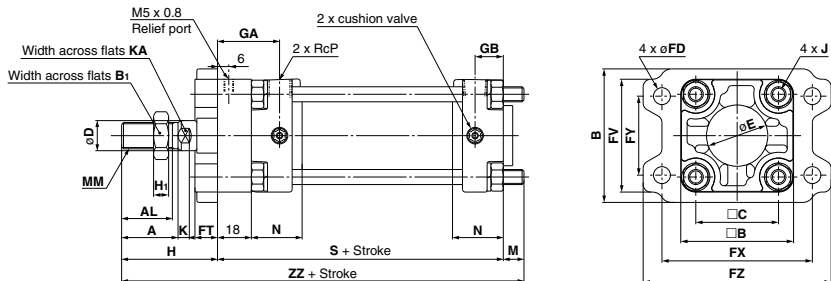

Symbol Bore size	Stroke range	A	AL	B	B1	C	D	E	FV	FD	FT	FX	FY	FZ	G	G	H	H1	J	K	KA	M	MM	N	P	S	ZZ	
40	Up to 1000	30	27	71	60	22	44	16	32	60	9	12	80	42	100	33	15	51	8	M8 x 1.25	6	14	11	M14 x 1.5	27	1/4	102	164
50	Up to 1000	35	32	81	70	27	52	20	40	70	9	12	90	50	110	35	17	58	11	M8 x 1.25	7	18	11	M18 x 1.5	30	3/8	108	177
63	Up to 1000	35	32	101	85	27	64	20	40	86	11.5	15	105	59	130	35	17	58	11	M10 x 1.25	7	18	14	M18 x 1.5	31	3/8	116	188

Head Flange (G): 10-CA2G, 21-CA2G

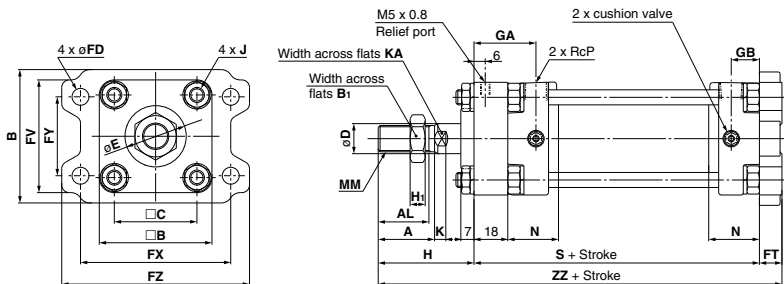

Symbol Bore size	Stroke range	A	AL	B	B1	C	D	E	FV	FD	FT	FX	FY	FZ	G	G	H	H1	J	K	KA	M	MM	N	P	S	ZZ	
40	Up to 1000	30	27	71	60	22	44	16	32	60	9	12	80	42	100	33	15	51	8	M8 x 1.25	6	14	11	M14 x 1.5	27	1/4	102	165
50	Up to 1000	35	32	81	70	27	52	20	40	70	9	12	90	50	110	35	17	58	11	M8 x 1.25	7	18	11	M18 x 1.5	30	3/8	108	178
63	Up to 1000	35	32	101	85	27	64	20	40	86	11.5	15	105	59	130	35	17	58	11	M10 x 1.25	7	18	14	M18 x 1.5	31	3/8	116	189