



Operation Manual

PRODUCT NAME

Voltage Monitor for PFMV5

MODEL / Series / Product Number

PFMV3##

SMC Corporation

Table of Contents

Safety Instructions	2
Model Indication and How to Order	9
Summary of Product parts	12
Definition and terminology	13
Mounting and Installation	15
Installation	15
Wiring	17
Flow Setting	21
Function Setting	23
Default settings	23
F0 Auto-preset	24
F1 Setting of OUT1	26
F2 Setting of OUT2	29
F3 Response time	30
F4 External input	31
F5 Power saving mode	36
F6 Security code	37
F95 Selection of flow indication	38
F99 Reset to the default setting	40
Other Setting	41
Maintenance	45
Troubleshooting	46
Error Indication	49
Specifications	50
Specifications	50
Characteristics data	52
Dimensions	54



Safety Instructions

These safety instructions are intended to prevent hazardous situations and/or equipment damage. These instructions indicate the level of potential hazard with the labels of "Caution", "Warning" or "Danger". They are all important notes for safety and must be followed in addition to International Standards (ISO/IEC)*1), and other safety regulations.

*1) ISO 4414: Pneumatic fluid power -- General rules relating to systems.

ISO 4413: Hydraulic fluid power -- General rules relating to systems.

IEC 60204-1: Safety of machinery -- Electrical equipment of machines .(Part 1: General requirements)

ISO 10218: Manipulating industrial robots -Safety.

etc.



Caution

Caution indicates a hazard with a low level of risk which, if not avoided, could result in minor or moderate injury.



Warning

Warning indicates a hazard with a medium level of risk which, if not avoided, could result in death or serious injury.



Danger

Danger indicates a hazard with a high level of risk which, if not avoided, will result in death or serious injury.

Warning

1. The compatibility of the product is the responsibility of the person who designs the equipment or decides its specifications.

Since the product specified here is used under various operating conditions, its compatibility with specific equipment must be decided by the person who designs the equipment or decides its specifications based on necessary analysis and test results.

The expected performance and safety assurance of the equipment will be the responsibility of the person who has determined its compatibility with the product.

This person should also continuously review all specifications of the product referring to its latest catalog information, with a view to giving due consideration to any possibility of equipment failure when configuring the equipment.

2. Only personnel with appropriate training should operate machinery and equipment.

The product specified here may become unsafe if handled incorrectly.

The assembly, operation and maintenance of machines or equipment including our products must be performed by an operator who is appropriately trained and experienced.

3. Do not service or attempt to remove product and machinery/equipment until safety is confirmed.

1. The inspection and maintenance of machinery/equipment should only be performed after measures to prevent falling or runaway of the driven objects have been confirmed.

2. When the product is to be removed, confirm that the safety measures as mentioned above are implemented and the power from any appropriate source is cut, and read and understand the specific product precautions of all relevant products carefully.

3. Before machinery/equipment is restarted, take measures to prevent unexpected operation and malfunction.

4. Contact SMC beforehand and take special consideration of safety measures if the product is to be used in any of the following conditions.

1. Conditions and environments outside of the given specifications, or use outdoors or in a place exposed to direct sunlight.

2. Installation on equipment in conjunction with atomic energy, railways, air navigation, space, shipping, vehicles, military, medical treatment, combustion and recreation, or equipment in contact with food and beverages, emergency stop circuits, clutch and brake circuits in press applications, safety equipment or other applications unsuitable for the standard specifications described in the product catalog.

3. An application which could have negative effects on people, property, or animals requiring special safety analysis.

4. Use in an interlock circuit, which requires the provision of double interlock for possible failure by using a mechanical protective function, and periodical checks to confirm proper operation.



Safety Instructions

Caution

1. The product is provided for use in manufacturing industries.

The product herein described is basically provided for peaceful use in manufacturing industries. If considering using the product in other industries, consult SMC beforehand and exchange specifications or a contract if necessary.
If anything is unclear, contact your nearest sales branch.

Limited warranty and Disclaimer/Compliance Requirements

The product used is subject to the following "Limited warranty and Disclaimer" and "Compliance Requirements".

Read and accept them before using the product.

Limited warranty and Disclaimer

1. The warranty period of the product is 1 year in service or 1.5 years after the product is delivered, whichever is first.*2)

Also, the product may have specified durability, running distance or replacement parts. Please consult your nearest sales branch.

2. For any failure or damage reported within the warranty period which is clearly our responsibility, a replacement product or necessary parts will be provided.

This limited warranty applies only to our product independently, and not to any other damage incurred due to the failure of the product.

3. Prior to using SMC products, please read and understand the warranty terms and disclaimers noted in the specified catalog for the particular products.

***2) Vacuum pads are excluded from this 1 year warranty.**

A vacuum pad is a consumable part, so it is warranted for a year after it is delivered.

Also, even within the warranty period, the wear of a product due to the use of the vacuum pad or failure due to the deterioration of rubber material are not covered by the limited warranty.

Compliance Requirements

1. The use of SMC products with production equipment for the manufacture of weapons of mass destruction (WMD) or any other weapon is strictly prohibited.

2. The exports of SMC products or technology from one country to another are governed by the relevant security laws and regulation of the countries involved in the transaction. Prior to the shipment of a SMC product to another country, assure that all local rules governing that export are known and followed.

Caution

SMC products are not intended for use as instruments for legal metrology.

Products that SMC manufactures or sells are not measurement instruments that are qualified by pattern approval tests relating to the measurement laws of each country.

Therefore, SMC products cannot be used for business or certification ordained by the measurement laws of each country.

Operator

- ◆ This operation manual is intended for those who have knowledge of machinery using pneumatic equipment, and have sufficient knowledge of assembly, operation and maintenance of such equipment. Only those persons are allowed to perform assembly, operation and maintenance.
- ◆ Read and understand this operation manual carefully before assembling, operating or providing maintenance to the product.

■ Safety Instructions

Warning

- Do not disassemble, modify (including changing the printed circuit board) or repair.
An injury or failure can result.
- Do not operate the product outside of the specifications.
Do not use for flammable or harmful fluids.
Fire, malfunction, or damage to the product can result.
Verify the specifications before use.
- Do not operate in an atmosphere containing flammable or explosive gases.
Fire or an explosion can result.
This product is not designed to be explosion proof.
- Do not use the product in a place where static electricity is a problem.
Otherwise it can cause failure or malfunction of the system.
- If using the product in an interlocking circuit:
 - Provide a double interlocking system, for example a mechanical system
 - Check the product regularly for proper operationOtherwise malfunction can result, causing an accident.
- The following instructions must be followed during maintenance :
 - Turn off the power supply
 - Stop the air supply, exhaust the residual pressure and verify that the air is released before performing maintenanceOtherwise an injury can result.

Caution

- Do not touch the terminals and connectors while the power is on.
Otherwise electric shock, malfunction or damage to the product can result.
- After maintenance is complete, perform appropriate functional inspections and leak tests.
Stop operation if the equipment does not function properly or there is a leakage of fluid.

■ NOTE

- Follow the instructions given below when designing, selecting and handling the product.
- The instructions on design and selection (installation, wiring, environment, adjustment, operation, maintenance, etc.) described below must also be followed.
- *Product specifications
 - The direct current power supply used should be UL approved as follows.
Circuit (Class 2) of maximum 30 Vrms (42.4 V peak) or less, with UL1310 Class 2 power supply unit or UL1585 Class 2 transformer.
 - The product is a UL approved product only if it has a  mark on the body.
 - Use the specified voltage.
Otherwise failure or malfunction can result.
Insufficient supply voltage may not drive a load due to a voltage drop inside the product.
Verify the operating voltage of the load before use.
 - Do not exceed the specified maximum allowable load.
Otherwise it can cause damage or shorten the lifetime of the product.
 - Data stored by the product is not deleted, even if the power supply is cut off.
(Writing time: 1000000 cycles, Data duration: 20 years after power off.)
 - Reserve a space for maintenance.
Allow sufficient space for maintenance when designing the system.

●Product handling

*Installation

- Tighten to the specified tightening torque.

If the tightening torque is exceeded the mounting screws and brackets may be damaged.

If the tightening torque is insufficient, the product may be displaced and the mounting screws may come loose (Refer to page 15 "Mounting and Installation".)

- Do not apply excessive stress to the product when it is panel mounted

Otherwise damage to the product and disconnection from the panel mount can result.

- Ensure that the FG terminal is connected to ground when using a commercially available switch-mode power supply.

- Do not drop, hit or apply excessive shock to the product.

Otherwise damage to the internal parts can result, causing malfunction.

- Do not pull the lead wire forcefully, not lift the product by pulling the lead wire. (Tensile force 49 N or less)

Hold the product body when handling, to prevent damage, failure or malfunction

- Never mount a product in a location that will be used as a foothold.

The product may be damaged if excessive force is applied by stepping or climbing onto it.

*Wiring

- Do not pull the lead wires.

In particular, never lift a product equipped with fitting and piping by holding the lead wires.

Otherwise damage to the internal parts can result, causing malfunction or disconnection of the connector.

- Avoid repeatedly bending or stretching the lead wire, or placing heavy loads on it

Repeated bending stress or tensile stress can cause damage to the sheath, or breakage of the wires.

If the lead wire can move, fix it near the body of the product.

The recommended bend radius of the lead wire is 6 times the outside diameter of the sheath, or 33 times the outside diameter of the wire insulation material, whichever is larger.

Replace any damaged lead wire with a new one.

- Wire correctly.

Incorrect wiring can damage the product.

- Do not perform wiring while the power is on.

Otherwise damage to the internal parts can result, causing malfunction.

- Do not route wires and cables together with power or high voltage cables.

Otherwise the product can malfunction due to interference or noise and surge voltage from power and high voltage cables.

- Confirm proper insulation of wiring.

Poor insulation (interference from another circuit, poor insulation between terminals, etc.) can lead to excess voltage or current being applied to the product, causing damage.

- Keep wiring as short as possible to prevent interference from electromagnetic noise and surge voltage.

Do not use a cable longer than 30 m.

Wire the DC (-) line (blue) as close as possible to the power supply.

- When analogue output is used, install a noise filter (line noise filter, ferrite element, etc.) between the switch-mode power supply and this product.

*Environment

- Do not use the product in area that is exposed to corrosive gases, chemicals, sea water, water or steam.
Otherwise failure or malfunction can result.
- Do not use in a place where the product could be splashed by oil or chemicals.
If the product is to be used in an environment containing oils or chemicals such as coolant or cleaning solvent, even for a short time, it may be adversely affected (damage, malfunction, or hardening of the lead wires)
- Do not use in an area where electrical surges are generated.
If there is equipment generates large electrical surges (solenoid type lifter, high frequency induction furnace, motor, etc.) close to the product, damage or failure of the internal circuit may occur. Take measures against the surge sources, and prevent the wires from coming into close contact.
- Do not use a load which generates a surge voltage.
When a surge-generating load such as a relay or solenoid is driven directly, use a product with a built-in surge absorbing element.
- The product is CE marked, but not immune to lightning strikes. Take measures against lightning strikes in the system.
- Do not use the product in areas that are exposed to vibration or impact.
Otherwise failure or malfunction can result.
- Do not use the product in the presence of a magnetic field.
This may lead to the malfunction of the product.
- Prevent foreign matter such as wire debris from entering the product.
Otherwise failure or malfunction can result.
- Do not use the product in areas subject to large temperature cycle.
Heating/cooling cycles other than ordinary changes in temperature can adversely affect the internal structure of the product
- Do not expose the product to direct sunlight.
If using in a location directly exposed to sunlight, use a suitable protective cover.
Otherwise failure or malfunction can result.
- Keep within the operating temperatures range.
Operating temperature range is 0 to 50 °C.
Operation below the minimum temperature limit may cause damage or operation failure due to frozen moisture in the fluid or air.
Avoid sudden temperature changes even within the specified temperature range.
- Do not operate close to a heat source, or in a location exposed to radiant heat.
Otherwise malfunction can result.

*Adjustment and Operation

- Connect load before turning on the power.
- Do not short-circuit the load.
Although an error is displayed when the product load is short circuited, excess current may cause damage to the product.
- Do not press the setting buttons with a sharp pointed object.
This may damage the setting buttons.
- Supply the power when there is no flow.
- The output is off for 3 seconds after power is supplied.
- Use settings suitable for the operating conditions.
Incorrect settings can cause operational failure.
(Refer to page 21 " Flow setting ".)
- During the initial setting and any subsequent flow rate setting, the product will switch the output according to the existing settings until the changes are complete.
Confirm the output has no adverse effect on machinery and equipment before setting.
Stop the control system before setting if necessary.
- Do not touch the LCD during operation.
The display can vary due to static electricity.

*Maintenance

- Perform regular maintenance and inspections.
There is a risk of unexpected malfunction of components due to the malfunction of equipment and machinery.
- Turn off the power supply, stop the supplied air, exhaust the residual pressure and verify the release of air before performing maintenance.
There is a risk of unexpected malfunction.
- Do not use solvents such as benzene, thinner etc. to clean the product.
They could damage the surface of the body and erase the markings on the body.
Use a soft cloth to remove stains.
For heavy stains, use a cloth lightly dampened with diluted neutral detergent, then wipe up any residue with a dry cloth.

Model Indication and How to order

PFMV 3 - -

Separate type monitor

Input specification

Model	Content	Applicable model
0	Voltage input	PFMV5□(F)-1-□□

Output specification

Model	Content
0	NPN (2 outputs) + Analogue (1 to 5 V)
1	NPN (2 outputs) + Analogue (4 to 20 mA)
2	NPN (2 outputs) + External input*1
3	PNP (2 outputs) + Analogue (1 to 5 V)
4	PNP (2 outputs) + Analogue (4 to 20 mA)
5	PNP (2 outputs) + External input*1

*1: Auto-shift and auto-shift zero are selectable.

Calibration certificate

Model	Content
Nil	without calibration certificate
A	with calibration certificate*2

*2: Certificate in both Japanese and English.
Calibration certificate is for indicated voltage value, not for indicated flow value.

Operation manual

Model	Content
Nil	with operation manual
N	without operation manual

Option 3
(Refer to page11.)

Option 2
(Refer to page10.)

Option 1
(Refer to page10.)

Unit specification

Model	Content
Nil	Unit selection function*3
M	SI units only*4

*3: Since the unit for Japan is fixed to SI due to new measurement law, this option is for overseas.

*4: Fixed unit Voltage: V, Instantaneous flow: L/min.

Option 1

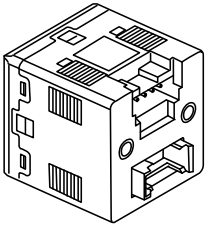
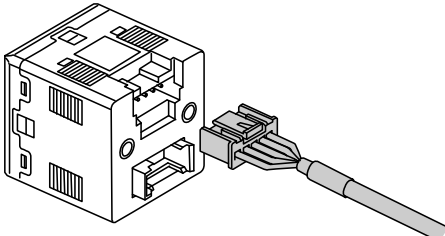
Nil	L
<p>without lead wire</p> 	<p>with power and output lead wire and connector</p> 

Option 2

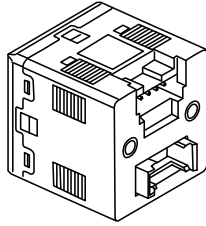
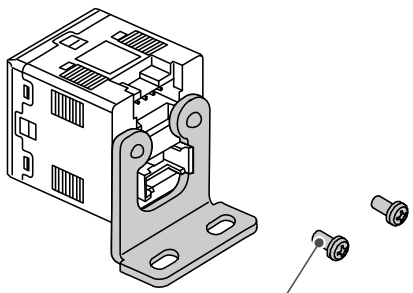
Nil	E
<p>without bracket</p> 	<p>with bracket</p>  <p>Mounting screw (M3 x 5 L)</p>

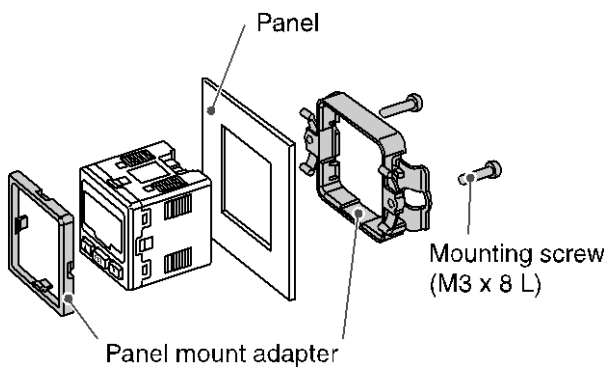
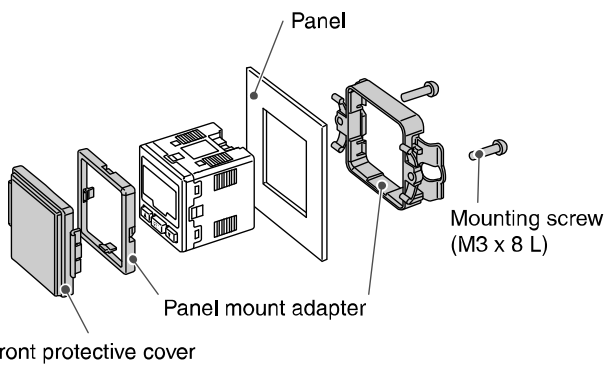
B	D
<p>with panel mount adapter</p>  <p>Panel</p> <p>Panel mount adapter</p> <p>Mounting screw (M3 x 8 L)</p>	<p>with panel mount adapter + front protective cover</p>  <p>Panel</p> <p>Panel mount adapter</p> <p>Front protective cover</p> <p>Mounting screw (M3 x 8 L)</p>

*: Each accessory is not assembled with the product, but shipped together.

Option 3

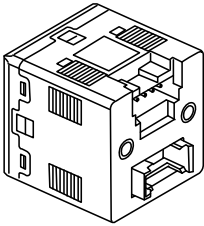
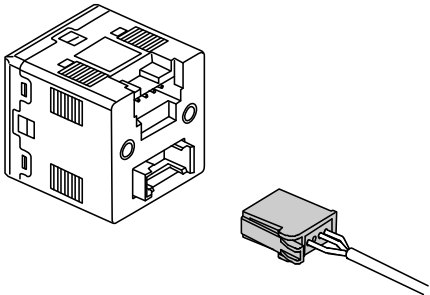
Nil	G
<p data-bbox="212 376 518 405">without connector for sensor</p> 	<p data-bbox="863 376 1166 405">with sensor connector (1pc)</p> 

*: Each accessory is not assembled with the product, but shipped together.

Accessories/Part number

If an accessory is required separately, order using the following part numbers.

Part number	Description	Remarks
ZS-28-A	Power and output lead wire and connector	Length: 2 m
ZS-28-B	Bracket	Mounting screw (M3 x 5 L) 2 pcs.
ZS-28-C	Sensor connector	1 pc.
ZS-27-C	Panel mount adapter	Mounting screw (M3 x 8 L) 2 pcs.
ZS-27-D	Panel mount adapter + Front protective cover	Mounting screw (M3 x 8 L) 2 pcs.
ZS-27-01	Front protective cover	

Summary of Product parts

Front

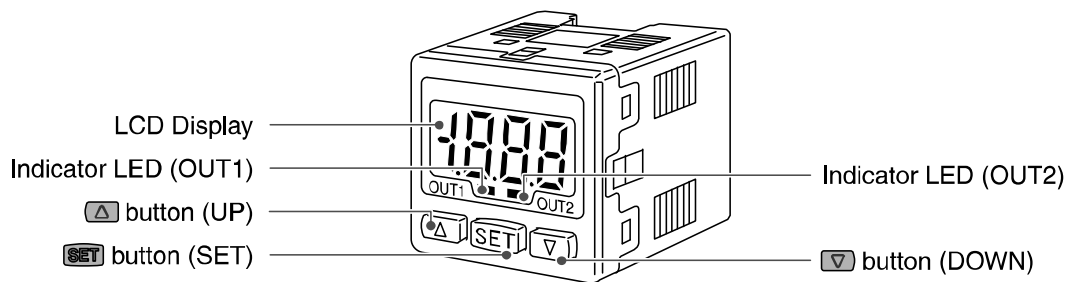

Item	Description
LCD Display	Displays the flow value, setting mode, and error indication. Four display modes can be selected: display always in red or green, or display changing from green to red, or red to green, according to the output status (OUT1).
Indicator LED (OUT1)	Indicates the output status of OUT1. LED is ON (Green) when OUT1 is ON.
Indicator LED (OUT2)	Indicates the output status of OUT2. LED is ON (Red) when OUT2 is ON.
button (UP)	Selects the mode or increases the ON/OFF set value. Press this button to change to the peak display mode.
button (SET)	Press this button to change to another mode and to set a value.
button (DOWN)	Selects the mode or decreases the ON/OFF set value. Press this button to change to the bottom display mode.

Back

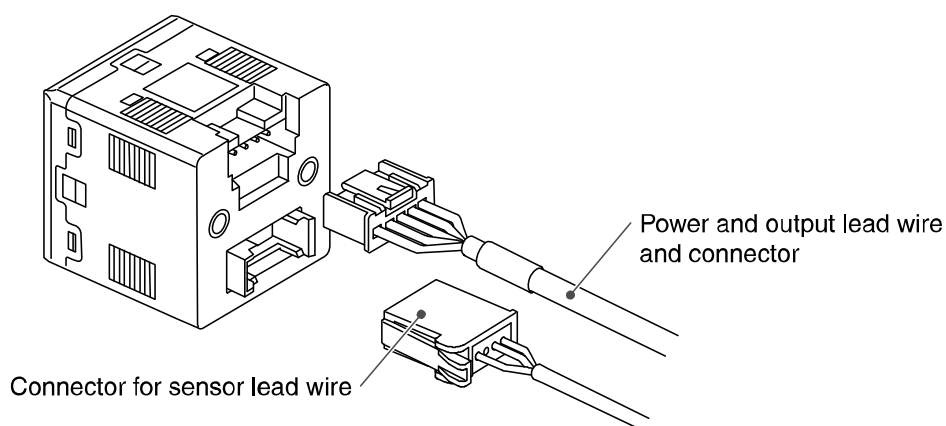

Item	Description
Power and output lead wire and connector	Cable to supply power and transmit output signals.
Sensor connector	Connector for sensor lead wire.

■ Definition and terminology

	Terminology	Definition
A	Analogue output	A type of variable output that has a value proportional to the measured quantity. When the analogue output is in the range of 1 to 5 V or 4 to 20 mA, it will vary continuously, following the change of flow.
	Auto-preset	This function calculates and sets an approximate set value automatically based on the on-going operation.
	Auto-shift	A function where the switch output state is determined by the change in instantaneous flow rate, relative to a reference value set when an external signal is input.
	Auto-shift zero	As the auto-shift function, but in addition the display is also set to zero when the external signal is input, and so the display shows the change of instantaneous flow from the reference value.
C	Chattering	The problem of the switch output turning ON and OFF repeatedly around the set value at high frequency due to the effect of pulsation.
D	Display voltage (flow) range	The range that which can be displayed by the product with a digital display.
F	F.S. (Full span, Full scale)	Stands for "full span" or "full scale", and indicates varied analogue output range at rated value. For example, when analogue output is 1 to 5 V, F.S. = 5[V] - 1[V] = 4[V], (ref. 1%F.S. = 4[V]x1% = 0.04[V]) The maximum measuring range or change in analogue output over the maximum measurement range.
H	Hysteresis	The difference between ON and OFF points used to prevent chattering. Hysteresis can be effective in avoiding the effects of pulsation.
	Hysteresis mode	Mode where the switch output will turn ON when the flow is greater than the set value, and will turn off when the flow falls below the set value – hysteresis value.
I	Instantaneous flow	The flow passing per unit of time. If it is 10 L/min, there is a flow of 10 L passing through the device in 1 minute.
	Internal voltage drop	The voltage drop across the product (and therefore not applied to the load), when the switch output is ON. The voltage drop will vary with load current, and ideally should be 0 V.
K	Key-lock function	A function that locks the set buttons so that no accidental setting changes can be made.
M	Minimum. setting unit	The resolution of set and display values. If the minimum setting unit is 1 L/min, the flow can be displayed in 1 L/min units, i.e. 10, 11, 12.
O	Operating humidity range	The ambient humidity range within which the product will meet all published specifications.
	Operating temperature range	The ambient temperature range within which the product will meet all published specifications.

	Terminology	Definition
P	Power saving mode	The condition in which the digital display turns off and current consumption is reduced.
R	Rated flow range	The flow range within which the product will meet all published specifications.
	Repeatability	Reproducibility of the display or analogue output value, when the measured quantity is repeatedly increased and decreased
	Response time (Analogue output)	The time from when the flow is applied as a step input (when the flow rate changes from 0% to 100% instantaneously) until the analogue output (voltage or current) reaches 90% of the actual flow rate.
	Response time (Switch output)	The time from when the flow is applied as a step input (when the flow rate changes from 0% to 100% instantaneously) until the switch output turns ON (OFF) at 90% of the rated flow rate.
S	Set voltage (flow) range	The range of ON/OFF threshold values that can be set for those products with a switch output.
	Switch output	Output type that has only 2 conditions, ON or OFF. When in the ON condition an indicator light will show, and any connected load will be powered. When in the OFF condition, there will be no indicator light and no power is supplied to the load.
T	Temperature characteristic	The amount of variation in the analogue output or display value when ambient temperature is changed.
U	Unit selection function	A function to select display units other than the international unit (SI unit) specified in the new Japanese measurement law. Flow can only be displayed using SI units in Japan.
W	Window comparator mode	An operating mode in which the switch output is turned on and off depending on whether the flow is inside or outside the range of two set values.

Mounting and Installation

■ Installation

Panel mounting

- Fix the panel mount adapter to the monitor with the mounting screws (M3x8 L) supplied.
- The monitor can be mounted on a panel with a thickness of 0.5 to 6.0 mm.
- Refer to the dimension drawing (page 54) for panel cut-out dimensions.

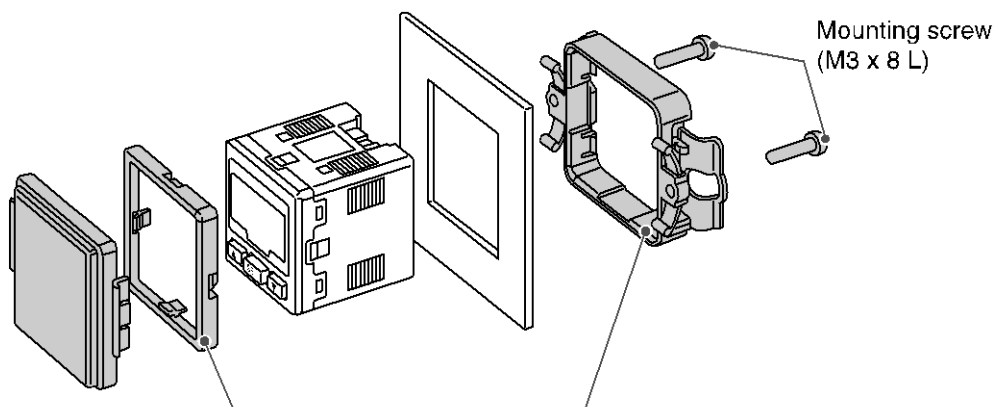

Panel mount adapter (can be rotated 90 degrees for mounting).

Note when removing the monitor

- The flow monitor with panel mount adapter can be removed from the installation by removing 2 screws and releasing the hooks at the sides, as illustrated.
- Take care not to damage the product and panel mount adapter.

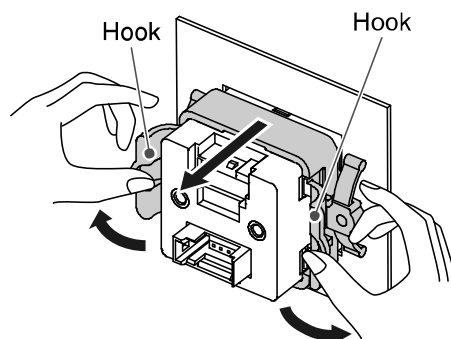

Bracket mounting

- Mount the bracket using the mounting screws (M3 x 5 L) supplied.
- The required tightening torque is 0.5 to 0.7 Nm.

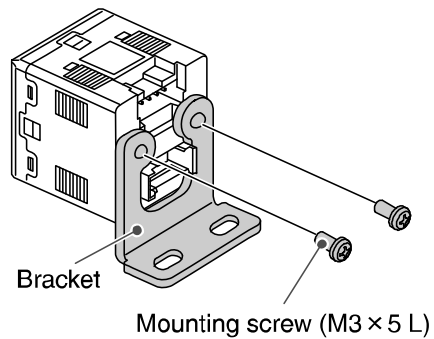

- Install the product (with bracket) using the M4 screws (2 pcs.).
- Bracket thickness is approximately 1.6 mm.
- Refer to the dimension drawing of the bracket (page 55) for mounting hole dimensions.

■ Wiring

Wiring of connector

- Connections should only be made with the power supply turned off.
- Use separate routes for the product wiring and any power or high voltage wiring. Otherwise, malfunction may result due to noise.
- Ensure that the FG terminal is connected to ground when using a commercially available switch-mode power supply. When a switch-mode power supply is connected to the product, switching noise will be superimposed and the product specification can no longer be met. This can be prevented by inserting a noise filter, such as a line noise filter and ferrite core, between the switch-mode power supply and the product, or by using a series power supply instead of a switch-mode power supply.

Attaching the connector to the sensor wire

- Strip the sensor wire as shown.
- Do not cut the insulator.
- Insert the corresponding wire colour shown in the table into the pin number printed on the sensor connector, to the bottom.

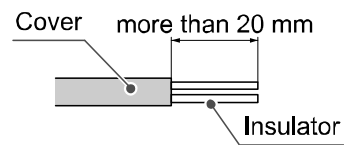

Pin no.	Wire colour	Description
1	Brown	DC+
2	NC	NC
3	Blue	DC-
4	Black	IN (1 to 5 V)

- Check that the above preparation has been performed correctly, then part A shown should be pressed in by hand to make temporary connection.

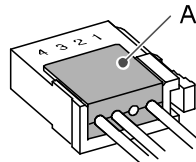

- Part A should then be pressed in using a suitable tool, such as pliers.

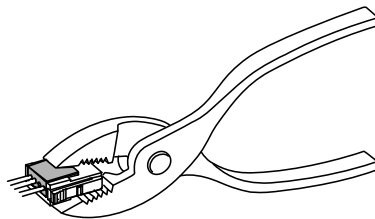

- The sensor connector cannot be re-used once it has been fully crimped. In cases of connection failure such as incorrect order of wires or incomplete insertion, please use a new connector.
- If the sensor is not connected correctly “LLL” or “HHH” will be displayed.

Connecting/Disconnecting

- When mounting the connector, insert it straight into the socket, holding the lever and connector body, and push the connector until the lever hooks into the housing, and locks.
- When removing the connector, press down the lever to release the hook from the housing and pull the connector straight out.

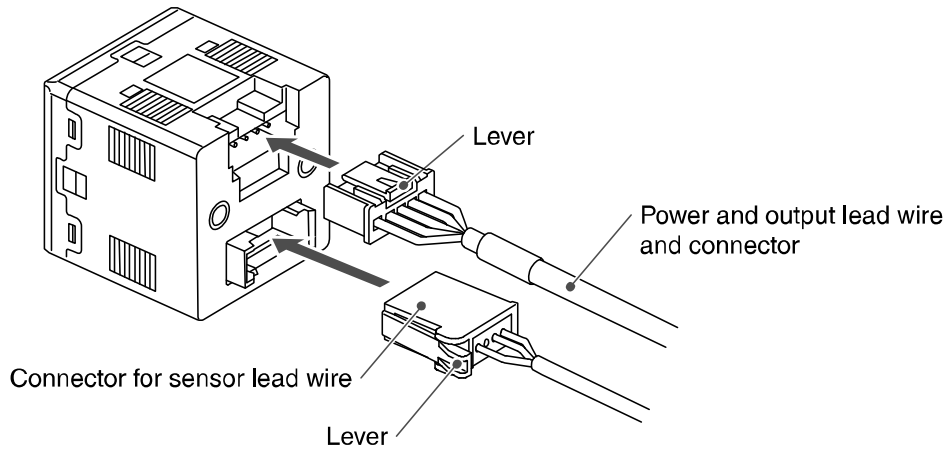

Power and output connector pin numbers (on the lead wire)

Wire cable	Description
Brown	DC(+)
Black	OUT1
White	OUT2
Grey	Analogue output/External input
Blue	DC(-)

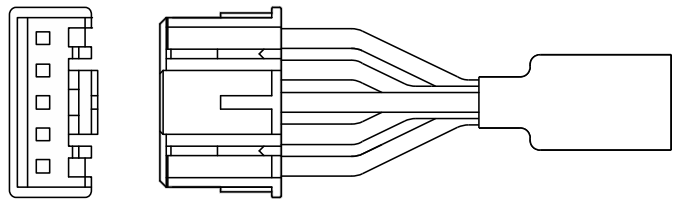

Internal circuit and wiring example

PFMV300

NPN (2 outputs) + Analogue (1 to 5 V) output type

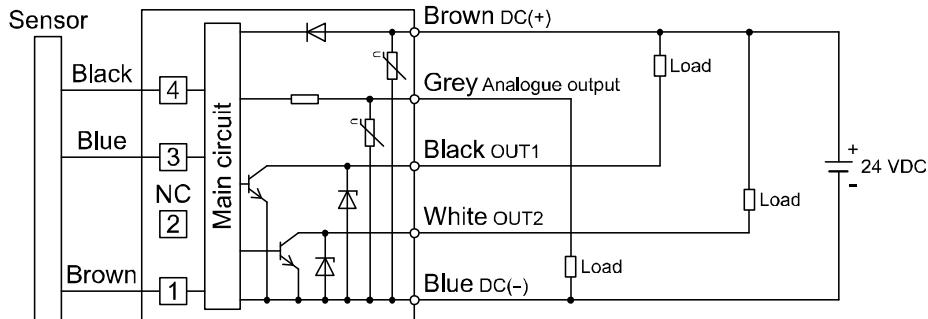

Max. 30 V, 80 mA

Internal voltage drop: 1 V or less

Analogue output: 1 to 5 V

Output impedance: approx. 1 k Ω

PFMV301

NPN (2 outputs) + Analogue (4 to 20 mA) output type

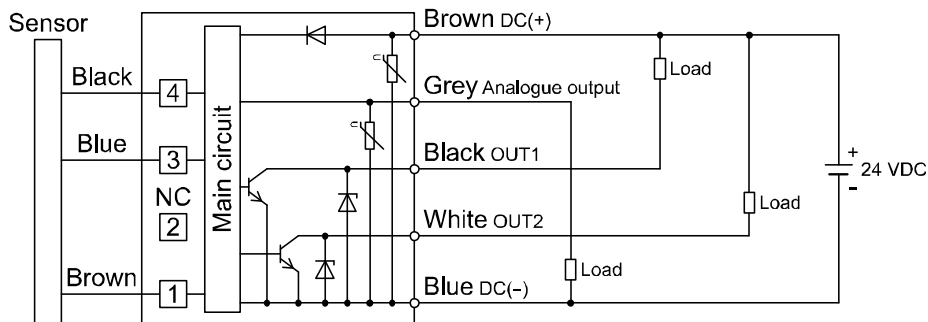

Max. 30 V, 80 mA

Internal voltage drop: 1 V or less

Analogue output: 4 to 20 mA

Max. load impedance: 600 Ω (24 VDC)

PFMV302

NPN (2 outputs) + External input type

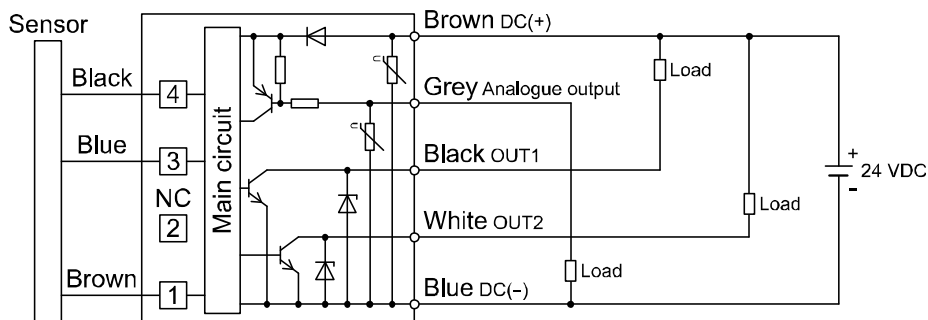

Max. 30 V, 80 mA

Internal voltage drop: 1 V or less

External input: No voltage input (reed switch or solid state), 5 ms or more

PFMV303

PNP (2 outputs) + Analogue (1 to 5 V) output type

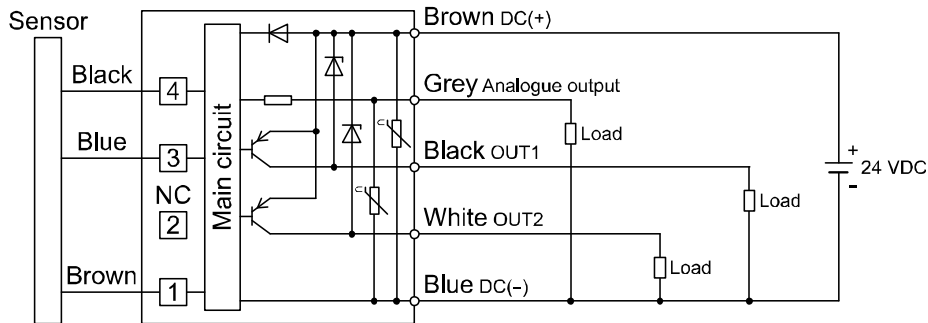

Max. 80 mA
 Internal voltage drop: 1 V or less
 Analogue output: 1 to 5 V
 Output impedance: approx. 1 kΩ

PFMV304

PNP (2 outputs) + Analogue (4 to 20 mA) output type

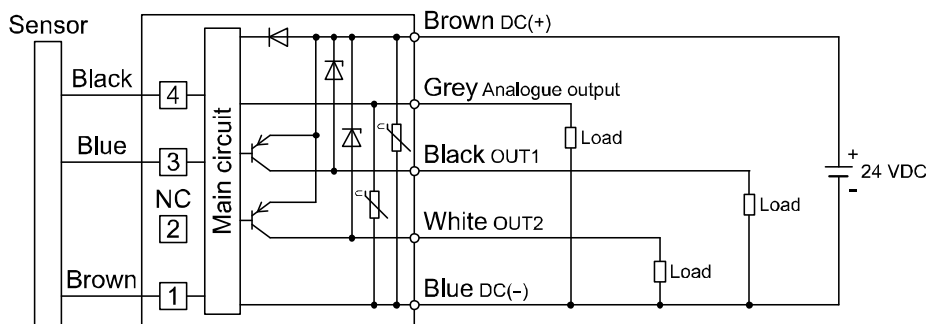

Max. 80 mA
 Internal voltage drop: 1 V or less
 Analogue output: 4 to 20 mA
 Max. load impedance: 600 Ω (24 VDC)

PFMV305

PNP (2 outputs) + External input type

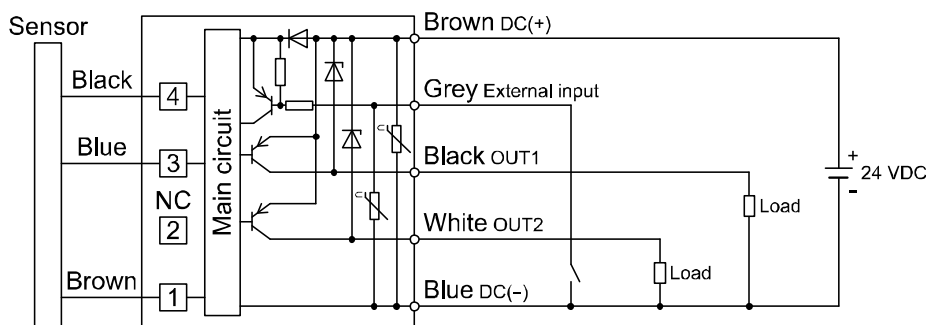

Max. 80 mA
 Internal voltage drop: 1 V or less
 External input: No voltage input (reed switch or solid state), 5 ms or more

Flow Setting

Measurement mode

The mode in which the flow is detected and displayed, and the switch function is operating. This is the basic operating mode; other modes should be selected for set-point and other Function Setting changes.

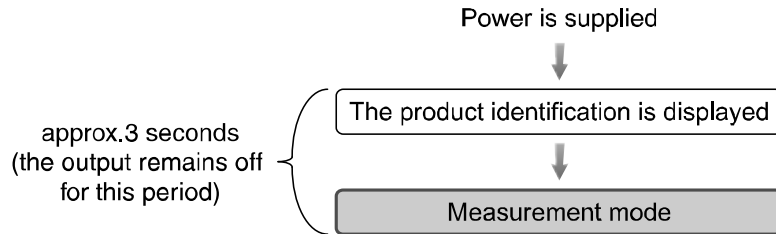

*: The display will indicate [LLL] if a sensor is not connected.

To use the product for flow rate indication, select the connected flow sensor using function [F95] before setting any other functions.

Switch operation

When the flow (or voltage) falls below the set value by the amount of hysteresis or more, the switch will turn ON.

When the flow (or voltage) exceeds the set value, the switch will turn OFF.

If this condition, shown to the right, is acceptable, then keep these settings.

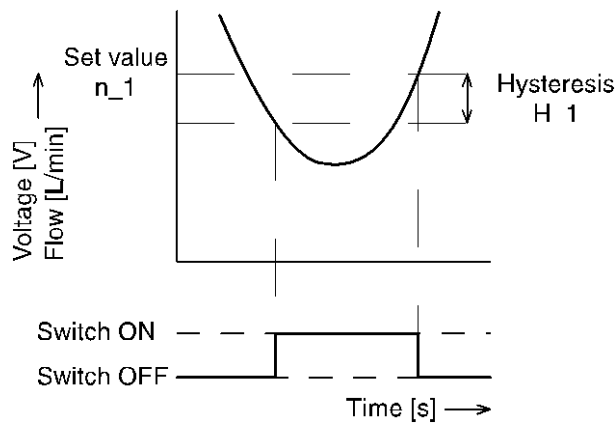

<Operation> *: The Product outputs will continue operating during setting.

1. Press the **SET** button in measurement mode to display the set values.

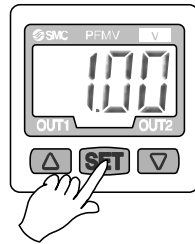

[P_1] or [n_1] and the set value are displayed in turn.

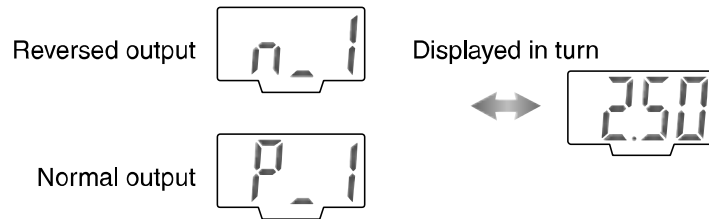

*: [LLL] is displayed during measurement mode when the sensor is not connected.

2. Press the **▲** or **▼** button to change the set value.

The **▲** button is to increase and the **▼** button is to decrease the set value.

- Press the **▲** button once to increase by one digit, or press it continuously to keep increasing the set value.

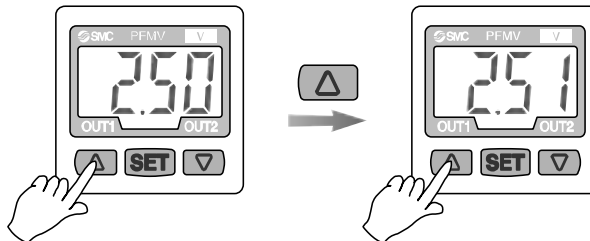

- Press the **▼** button once to decrease by one digit, or press it continuously to keep decreasing the set value.

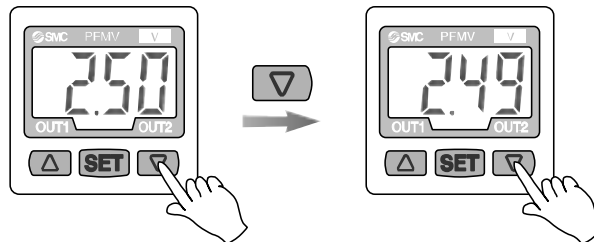

3. Press the **SET** button to finish the setting of OUT1.

[n_2] or [P_2] will be displayed. Set as above.

Standard value offset function

The display can be offset to the standard value by pressing the **▲** and **▼** buttons simultaneously for 1 second or longer. (page 41)

For the initial operation, always perform the standard value offset function with no flow applied.

Function Setting

Function selection mode

In measurement mode, press the **SET** button for 2 seconds or longer, to display [F 0].

The [F□□] indicates the mode for changing each function setting.

Press the **SET** button for 2 seconds or longer in function selection mode to return to measurement mode.

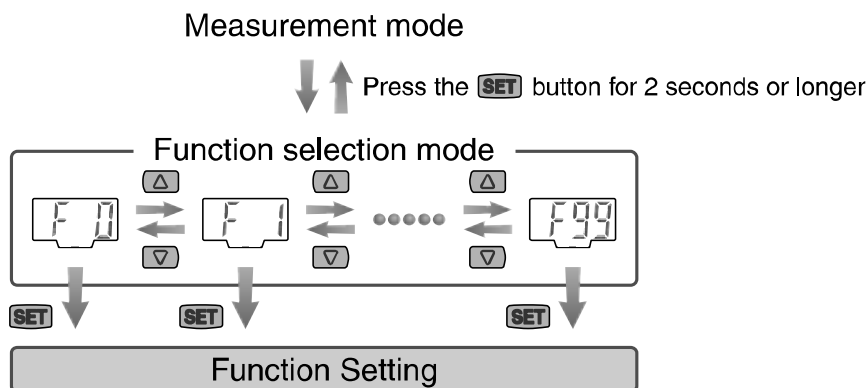



■Default setting

	Item	Default setting	Page
[F 0]	Auto-preset	-	Page 24
[F 1]	[oU1] Output mode (OUT1)	[HYS] Hysteresis mode	Page 26
	[1ot] Reversed output (OUT1)	[1_n] Reversed output	
	[n_1] Input of set value (OUT1)	[2.50] (Voltage display)	Page 27
	[H_1] Setting of hysteresis (OUT1)	[0.12] (Voltage display)	
	[CoL] Display colour	[SoG] ON: Green OFF: Red	
[F 2]	[oU2] Output mode (OUT2)	[HYS] Hysteresis mode	Page 29
	[2ot] Reversed output (OUT2)	[2_n] Reversed output	
	[n_2] Input of Set value (OUT2)	[2.50] (Voltage display)	
	[H_2] Setting of hysteresis (OUT2)	[0.12] (Voltage display)	
[F 3]	[rES] Response time	[.002] 2 msec.	Page 30
[F 4]	[inP] External input	[oFF] Unused	Page 31
[F 5]	[Eco] Power saving mode	[oFF] Unused	Page 36
[F 6]	[Pin] Security code	[oFF] Unused	Page 37
[F95]	[rAn] Select connected sensor	[oFF] Unused	Page 38
	[Uni] Unit selection function	[LPm] L/min	
[F99]	[ini] Reset to the default settings	[oFF] Unused	Page 40

■ [F 0] Auto-preset

This function is capable of calculating the approximate set value automatically based on the on-going operation.

<Operation>

Press the  or  button in t function selection mode to display [F 0].

Press the  button. ↓

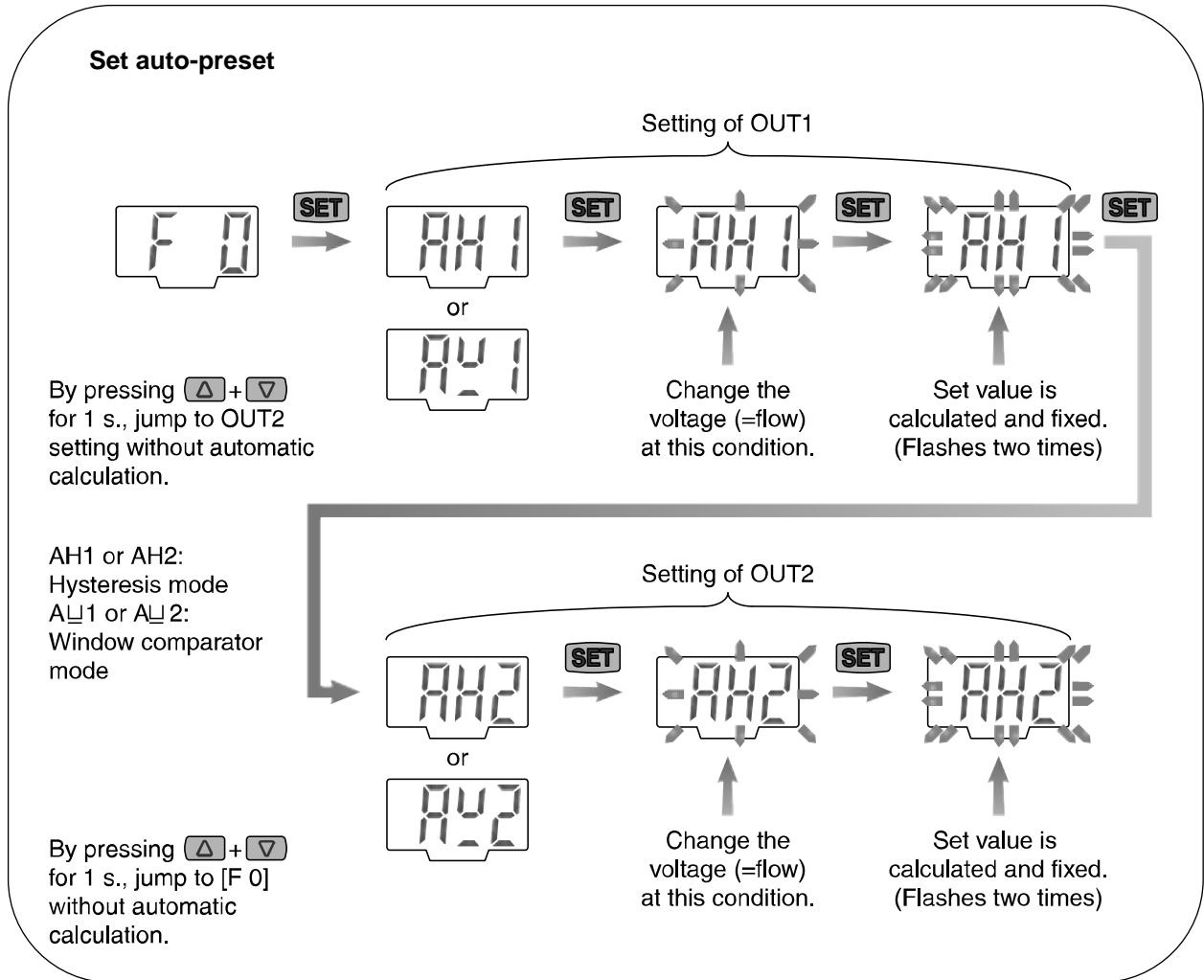

Press the  button. ↓ Return to function selection mode.

[F 0] Selection of auto-preset completed

- In auto-preset mode, the set value can be automatically calculated and stored.
Auto preset is a function to automatically calculate the approximate set values according to the actual operating condition.
If the **SET** button is pressed during measurement mode after auto-preset function is selected, the display will appear as shown in the table below.

• Display during auto preset

Output mode	OUT1		OUT2	
	Hysteresis Mode	Window comparator mode	Hysteresis Mode	Window comparator mode
Display during auto pre-set	AH1	AY1	AH2	AY2

The Display flashes when the **SET** button is pressed. The flow should be changed while the display is flashing.

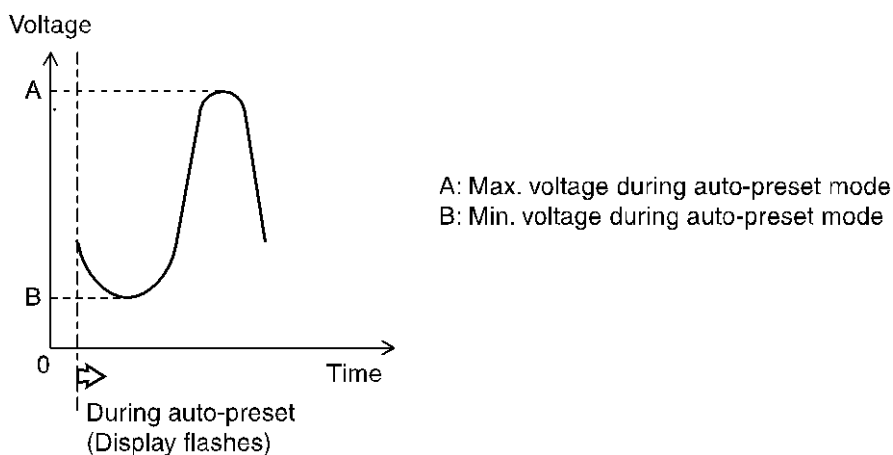

The set value is automatically calculated by pressing the **SET** button. Then, auto-preset mode setting is completed and the display will return to measurement mode.
The set values of auto-preset mode are calculated as follows

• Auto-preset set value

	Hysteresis mode	Window comparator mode
Set value	<ul style="list-style-type: none"> • $P_1 = A - (A - B) / 4$ • $H_1 = (A - B) / 2$ ($n_1 = B + (A - B) / 4$ in reversed output node)	<ul style="list-style-type: none"> • $P1L = B$ • $P1H = A$ • $H_1 = 5$ digit 1 digit means set minimum unit (In reversed output, P1L, P1H becomes n1L, n1H respectively)

Refer to the list of output operations (page 28) for the setting of hysteresis mode and window comparator mode.

■ [F 1] Setting of OUT1

Set output method of OUT1.

To use flow indication, select the flow sensor at [F95] selection of flow indication before setting the function.

<Operation>

Press the  or  button in function selection mode to display [F 1].

Press the  button. ↓

Select output mode

[oU1] and the set value are displayed in turn.

Press the  or  button to select.

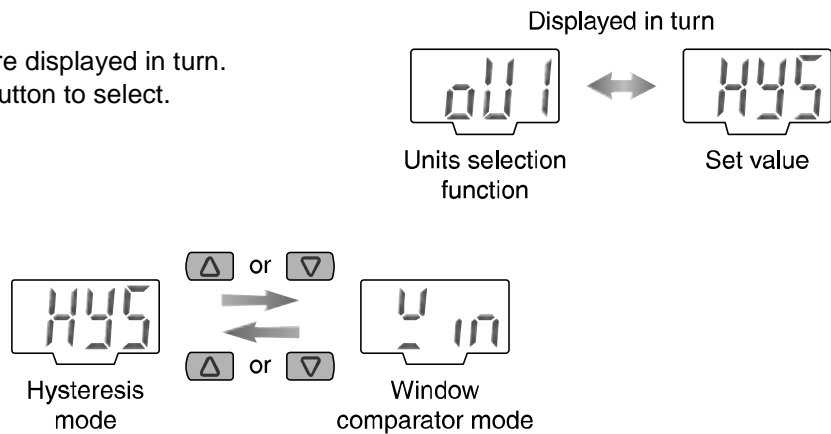

*: If hysteresis mode and window comparator mode is switched, set value is initialized.

Press the  button. ↓

Select reversed output

[1ot] and the set value are displayed in turn.

Press the  or  button to select.

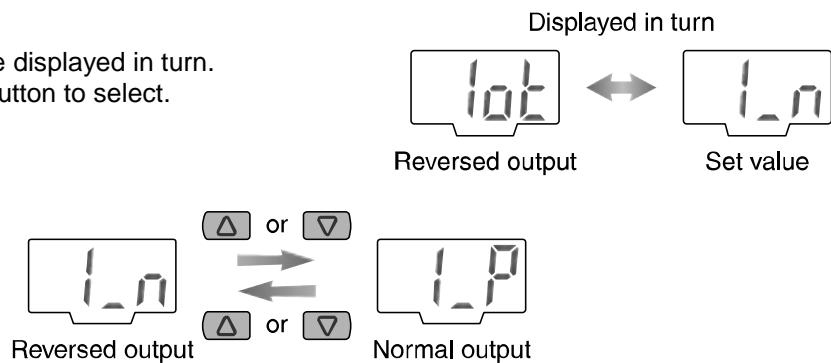

Press the  button. ↓ (continued).

Input of set values

Set flow based on setting operation on page 22.

Hysteresis mode: [n_1]

Window comparator mode: [n1L] [n1H]

*: For normal output, n becomes P.

Press the **SET** button. ↓

Setting of hysteresis

[H_1] and the set value are displayed in turn

Press the **▲** or **▼** button to input.

Window comparator mode: [H1]

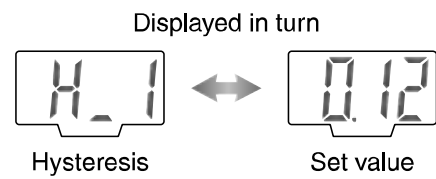

Press the **SET** button. ↓

Select display colour

[CoL] and the set value are displayed in turn

Press the **▲** or **▼** button to select.

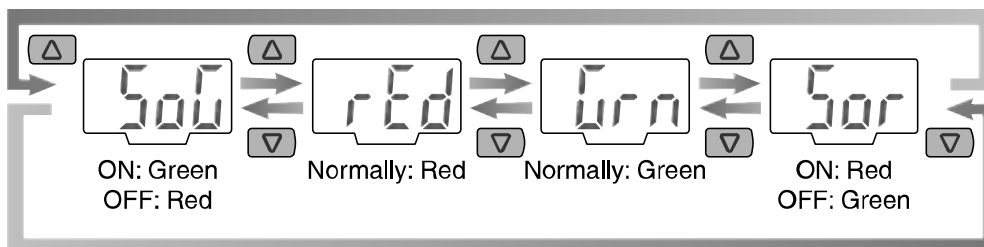
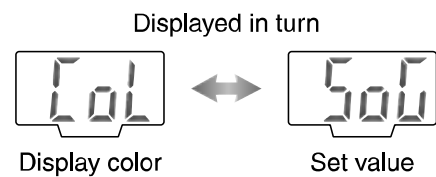

Press the **SET** button. ↓ Return to function selection mode.

[F 1] Setting of OUT1 completed

•List of output modes

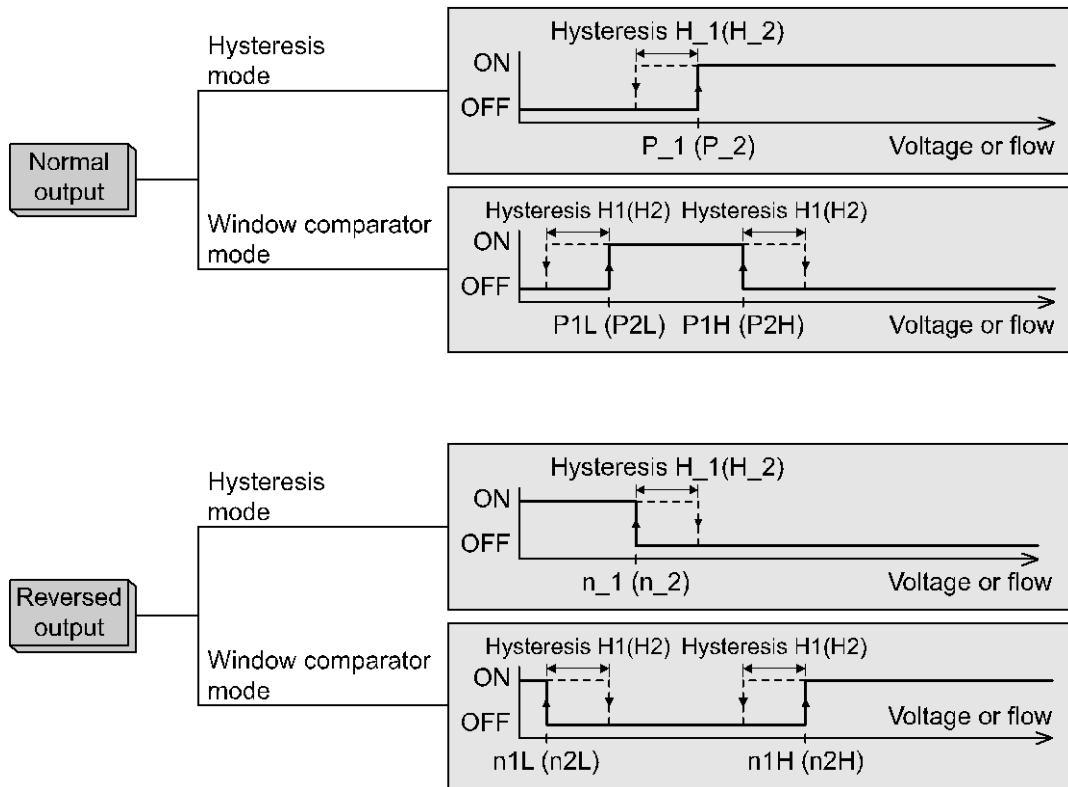

*: If hysteresis or window comparator mode is selected and there is an unstable flow condition (due to fluid pulsation, for example), unstable output operation can result. In such situations, keep sufficient margin between the set values and confirm that the output operation stabilizes.



■[F 2] Setting of OUT2

Set output method of OUT2.

The display colour is linked to the setting of OUT1, and can not be set for OUT2.

To use flow indication, select the flow sensor at [F95] selection of flow indication before setting the function.

<Operation>

Press the  or  button in function selection mode to display [F 2].

Press the  button. 

Set [F 2] based on [F 1] setting of OUT1

*: When product with analogue output function or external input function are used, this function is not available and [---] is displayed.

*: The part displayed as "1" for OUT1 setting is displayed as "2" for OUT2 setting.

<Ex.>n₁→n₂, H₁→H₂

■ [F 3] Response time



Select the response time of the switch output.

Output chattering can be prevented by setting the response time.



<Operation>

Press the  or  button in function selection mode to display [F 3].

Press the  button. ↓

Select response time
[rES] and the set value are displayed in turn.
Press the  or  button to select.

Displayed in turn

 ↔ 
Response time Set value

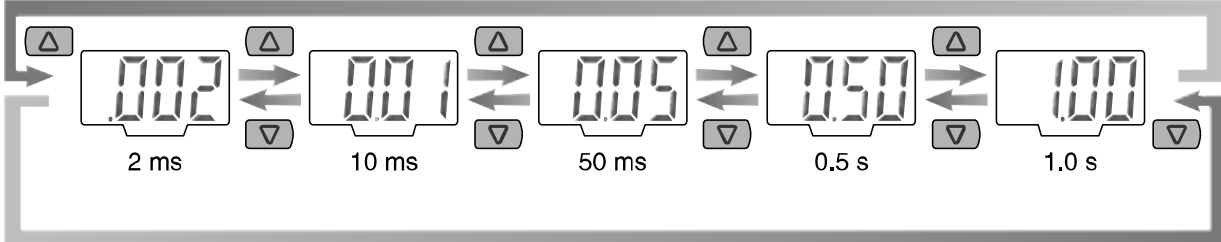

2 ms 10 ms 50 ms 0.5 s 1.0 s

Press the  button. ↓ Return to function selection mode.

[F 3] Selection of response time completed

*: If [.002] is selected during flow indication, actual response time is 3 ms.

■[F 4] External input

This function is available when the product includes the external input function

*: When using a product without external input function, [---] is displayed and this function cannot be set.

To use flow indication, select the flow sensor at [F95] selection of flow indication before setting the function.

Selection of flow indication changes the selected content of the external input function.

Set value of [F1] and [F2] is initialized when changing the setting of external input.

(continued).

Voltage indication



- Auto-shift: Function to perform output to relative voltage change referring the voltage value on the display when signal is input.

*: If PFMV5□ series (single direction) is selected, operation is based on 1.00 V (=sensor output value when the flow is zero.)

If PFMV5□F series (dual directional) is selected, operation is based on 3.00 V (=sensor output value when the flow is zero.)

- Input signal: Connect input wire to GND for 5 ms or longer

<Operation>

Press the  or  button in function selection mode to display [F 4]

Press the **SET** button. ↓

Select external input

[inP] and the set value are displayed in turn.

Press the  or  button to select.

Displayed in turn

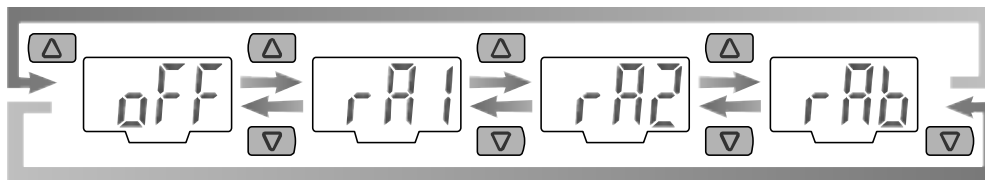
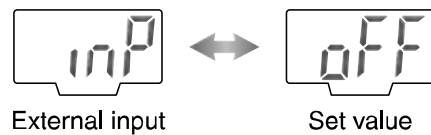

[rA1] Only OUT1 is valid

[rA2] Only OUT2 is valid

[rAb] Both OUT1, OUT2 are valid

Press the **SET** button. ↓

Select connect sensor

[Cos] and the set value are displayed in turn.

Press the  or  button to select.

Displayed in turn

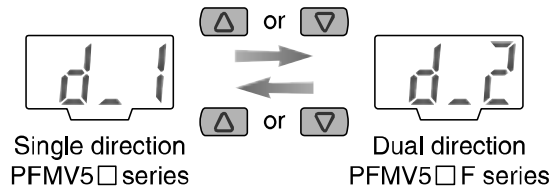
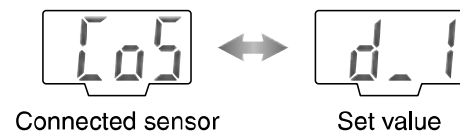

Press the **SET** button. ↓ Return to function selection mode.

[F 4] Selection of external input completed

Flow indication

- Auto-shift: Function to perform output to relative flow change referring the instantaneous flow when signal is input.
- Auto-shift zero: Function to perform output to relative change and clear the display value as zero referring the instantaneous flow when signal is input.



Input signal: Connect input wire to GND for 5 ms or longer

<Operation>

Press the  or  button in function selection mode to display [F 4].

Press the  button. ↓

Select external input

[inP] and the set value are displayed in turn.
Press the  or  button to select.

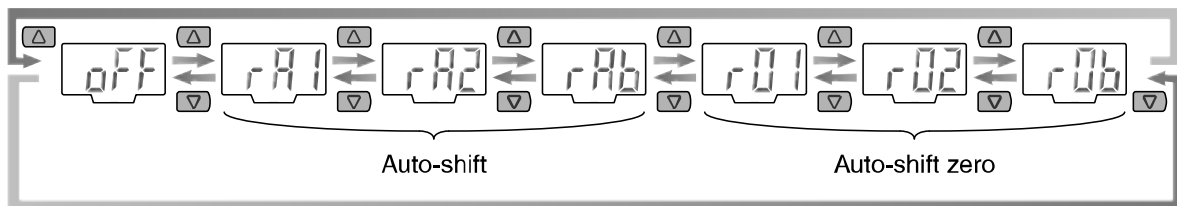
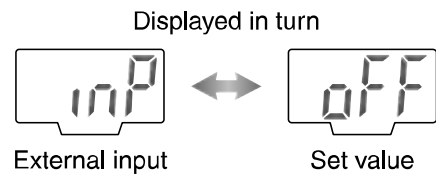

- [rA1] : Auto-shift input is valid for OUT1 only
- [rA2] : Auto-shift input is valid for OUT2 only
- [rAb] : Auto-shift input is valid for both OUT1 and OUT2
- [r01] : Auto-shift zero input is valid for OUT1 only
- [r02] : Auto-shift zero input is valid for OUT2 only
- [r0b] : Auto-shift zero input is valid for both OUT1 and OUT2

Press the  button. ↓ Return to function selection mode.

[F 4] Selection of external input completed

● Operation example of auto-shift (When voltage indication mode)

Voltage indication

<Ex.> This function is used during the confirmation of adsorption/release as a solution for voltage (=flow rate) change due to source pressure fluctuation or nozzle diameter change.

When auto-shift function is not used, even if the work is adsorbed, switching operation is not made when the voltage (=flow rate) amount fluctuates. Auto-shift function is useful for this case.

If auto-shift function is used, switching operation is made based on the time when auto-shift signal is input as reference. Therefore, switching operation is available without a fail as long as auto-shift signal is inputted during non-adsorption period.

Example below is of voltage indication mode.

● When auto-shift is not used

Switch set value: $n_1=1.60$, $H_1=0.40$ (reversed output, hysteresis mode)

ON/OFF point of this setting ... ● ON point: n_1

● OFF point: $(n_1)+(H_1)$

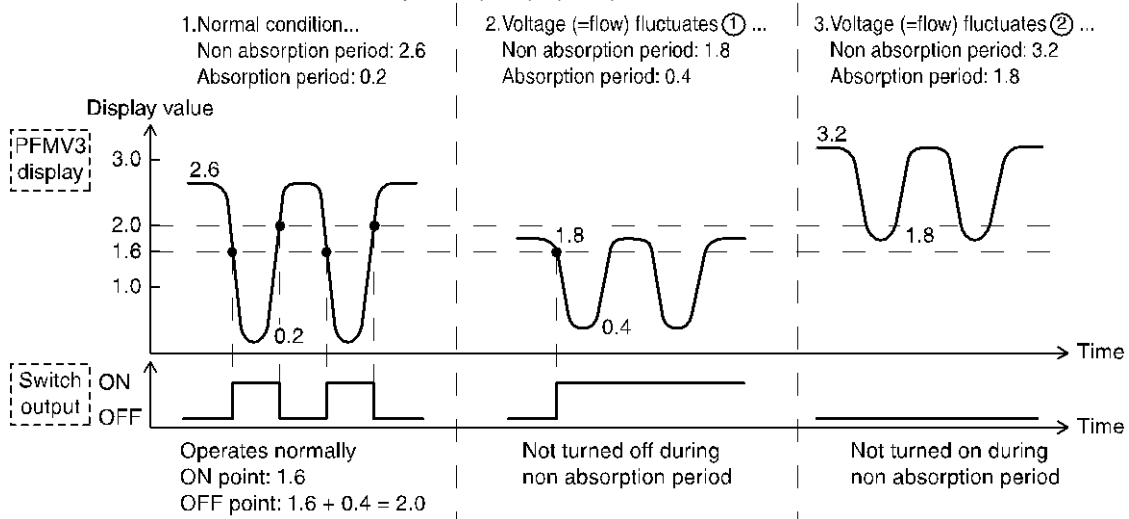

● When auto-shift is used

Switch set value: $n_1=-1.00$, $H_1=0.40$ (reversed output, hysteresis mode)

ON/OFF point of this setting ... ● ON point: (Flow when auto-shift is input)+(n_1)

● OFF point: (Flow when auto-shift is input)+(n_1)+(H₁)

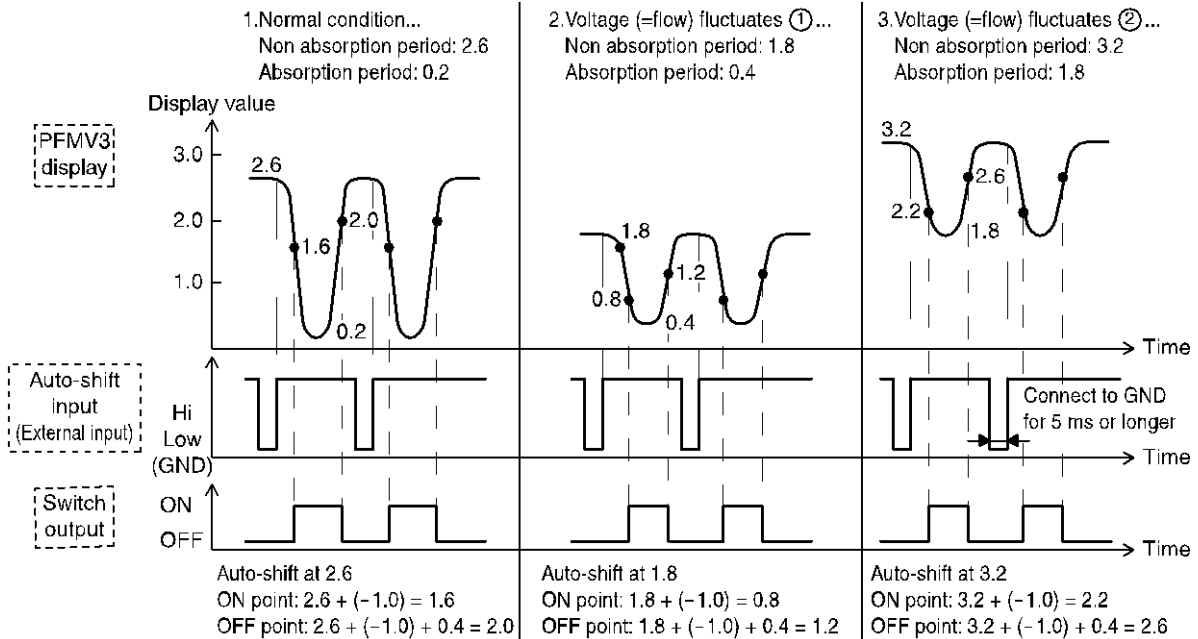

Setting range when auto-shift function is selected is -4.40 to 4.40.

If relative set value after the auto-shift is out of upper or lower limit, this monitor operates with upper limit (5.10) or lower limit (0.70).

*: When flow indication mode is selected, flow setting range when external input is selected is changed.

<Ex.> Flow range: Set at 3 [L/min.]

External input: Set to [rAb] (Set range of both OUT1 and OUT2 will be changed as below)



[L/min.] Unit: -3.30 to 3.30

[CFH] Unit: -6.99 to 6.99

■[F 5] Power saving mode

In power saving mode, the display can be turned off to reduce power consumption.
When the product is left for 30 seconds with no button operations, it will enter power saving mode.
The decimal point flashes during operation.

<Operation>

Press the  or  button in function selection mode to display [F 5].

Press the  button. ↓

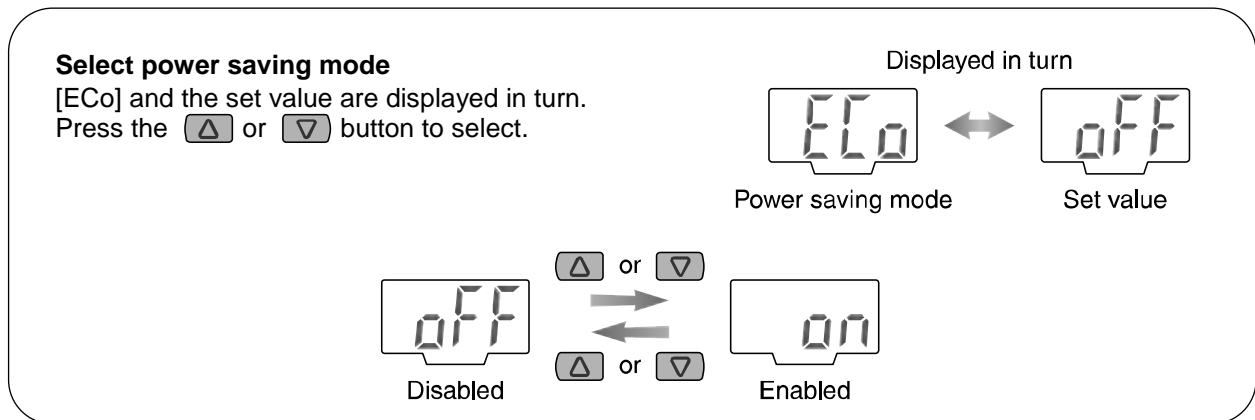

Press the  button. ↓ Return to function selection mode.

[F5] Selection of power saving mode completed

In power saving mode, any key operation will return the normal display.
If there is no key operations for 30 seconds, the display will return to power saving mode.
(Only in the measurement mode.)



During power saving mode,
only the decimal points will flash.



■[F 6] Security code

A security code can be selected, which must be entered to unlock the keys when the keys are locked. Refer to key-lock function (page 42).

<Operation>

Press the  or  button in function selection mode to display [F 6].

Press the  button 

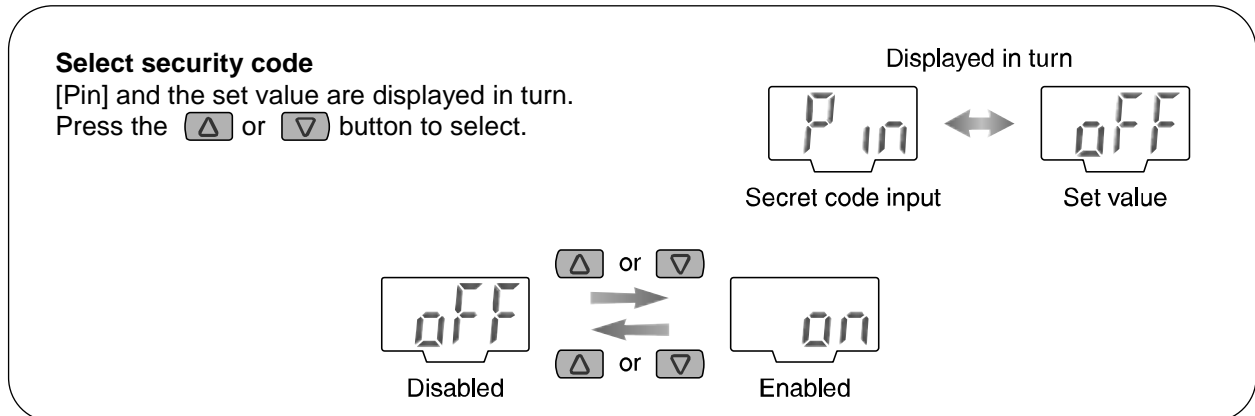

Press the  button.  Return to function selection mode.

[F 6] Selection of security code completed

■[F95] Selection of flow indication

The flow rate can be displayed. The flow rate units can be selected (for models with unit selection function) after selecting the connected sensor.

L/min or CFM (ft³/min) ×10⁻² are the selectable display units.



To use for flow rate indication, select the sensor and units before setting the functions [F1], [F2], [F4]. The set values for [F1], [F2] and [F4] will be reset when the flow indication setting is changed.

<Operation>

Press the  or  button in function selection mode to display [F95].

Press the  button. ↓

Select connected sensor

[rAn] and the set value are displayed in turn. Press the  or  button to select.

Displayed in turn

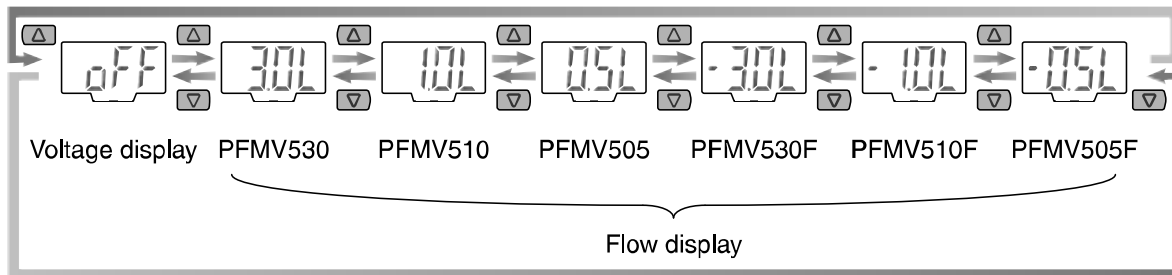
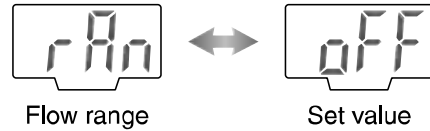



Connected sensor model	Displayed flow range	Rated flow range
PFMV530	3.0L	0 to 3.0 [L/min]
PFMV510	1.0L	0 to 1.0 [L/min]
PFMV505	0.5L	0 to 0.5 [L/min]
PFMV530F	-3.0L	-3.0 to 3.0 [L/min]
PFMV510F	-1.0L	-1.0 to 1.0 [L/min]
PFMV505F	-0.5L	-0.5 to 0.5 [L/min]

*: The set values of OUT1 and OUT2 will be reset when the flow range setting is changed.

Press the  button. ↓ (continued).

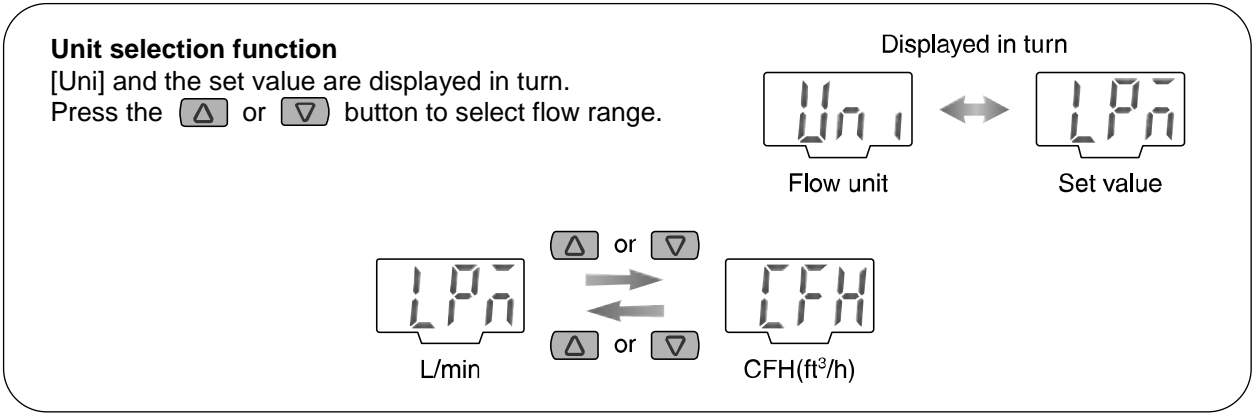
Flow unit selection is available only the product with the unit selection function.



Press the  button.  Return to function selection mode.

[F95] Selection of flow indication completed

When the unit is changed, use unit seal included in accessories.

Flow specification when [CFH] I selected by unit selection function

Model	PFMV505	PFMV510	PFMV530	PFMV505F	PFMV510F	PFMV530F
Rated flow range	0 to 1.05 ft ³ /h	0 to 2.11 ft ³ /h	0 to 6.35 ft ³ /h	-1.05 to 1.05 ft ³ /h	-2.11 to 2.11 ft ³ /h	-6.35 to 6.35 ft ³ /h
Setting/display flow range	-0.05 to 1.11 ft ³ /h	-0.10 to 2.22 ft ³ /h	-0.32 to 6.67 ft ³ /h	-1.11 to 1.11 ft ³ /h	-2.22 to 2.22 ft ³ /h	-6.67 to 6.67 ft ³ /h
Min. setting/display unit	0.01 ft ³ /h	0.01 ft ³ /h	0.01 ft ³ /h	0.01 ft ³ /h	0.01 ft ³ /h	0.01 ft ³ /h

*: Flow in the specification is the value at standard condition.

■ [F99] Reset to the default settings



The factory default settings can be restored.

<Operation>

Press the  or  button in function selection mode to display [F99].

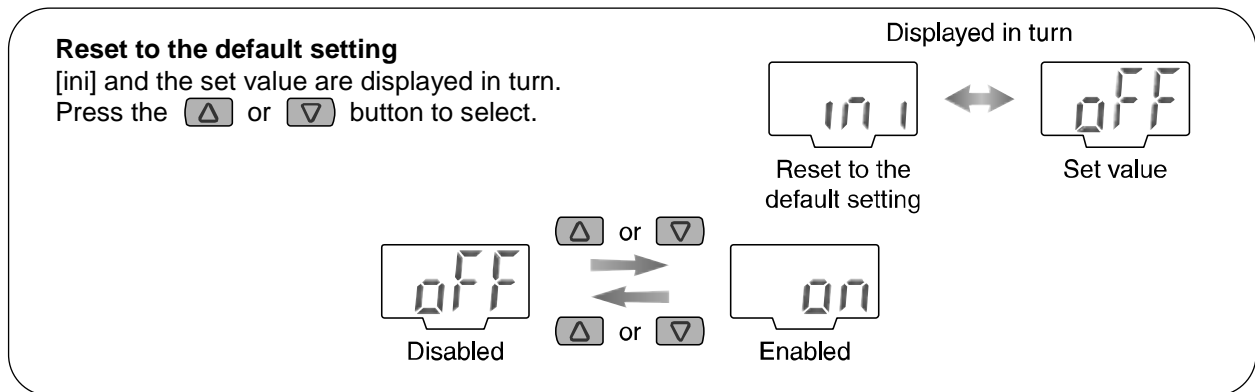
Press the  button. ↓



Press the  or  buttons simultaneously for 5 seconds or longer when ↓ Return to function selection mode. [on] is displayed

[F99] Reset to the default settings completed



Other Setting

● Standard value offset function

If the displayed value can be 1.00 due to the deviation in each product, the displayed value can be forcibly changed to 1.00 for PFMV505, 510 and 530.

During flow indication, the displayed value can be forcibly change to 0.00.

For PFMV505F, 510F and 530F, the forcibly changed value will be 3.00.

Press the  or  buttons together for 1 second or longer under the condition with no flow.

(If the offset is succeeded, the display starts flashing.)

The effective range of this function is 1.00 ± 0.2 V or 3.00 ± 0.2 V.

During flow indication, effective range for correction is $\pm 2\%$ F.S.

If this function is operated outside of the above range, the display shows “Er4” and the offset is not performed. Also, this function must be operated with no flow.

When the product is installed in a vertical direction.

Natural convection is generated due to the sensor characteristics around the zero flow range, so there is a possibility that an error up to approximately 3% F.S. might be generated. When the standard value offset function is to be used, be sure to complete the installation first.

For example, if there is a flow with PFMV505 connected, and the flow rate is around 3.00 V as sensor output, the offset function will start.

If this function is operated by mistake with a flow, make the condition with no flow, and retry to operate the function.

● Peak/Bottom value display

The maximum (minimum) instantaneous flow, from when the power was supplied to this moment, is detected and updated.



In the peak (bottom) value display mode, the maximum (minimum) instantaneous flow can be displayed.

For peak value display mode, when the  button is pressed for 1 second or longer, the maximum flow will be displayed flashing, and is held.

To release holding the peak value display, press the  button for 1 second or longer to return to measurement mode.

For bottom value display mode, when the  button is pressed for 1 second or longer, the minimum flow will be displayed flashing, and is held.

To release holding the bottom value display, press the  button for 1 second or longer to return to measurement mode.



If the  and  buttons are pressed simultaneously for 1 second or longer while the flow is being held, the peak (bottom) value is reset.

● Indicated content check function

This is the function to check if indicated content during measurement mode is voltage or flow rate.

This function is available only when flow indication is selected with function mode [F95].

<Operation>

Press the  or  button and release it within 1 second to indicate the flow range for 0.5 second which is selected by function mode [F95].

(If pressed for 1 second or longer, mode is changed to peak/bottom value indication mode on page 41.)

While voltage indication mode is selected, indicated content check function does not operate.

●Key Lock

The key lock function is used to prevent errors occurring due to unintentional changes of the set values. If a button operation is performed while the key lock setting is ON, [LoC] is displayed for approximately 1 second.

<Operation -without security code input- >

●Locking

1. Press the **SET** button for 5 seconds or longer in the measurement mode. [UnL] will be displayed.

2. Press the **Δ** or **▽** button to select keys lock [LoC].

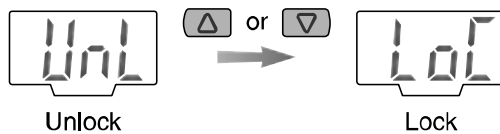

3. Press the **SET** button to store the setting and return to measurement mode.

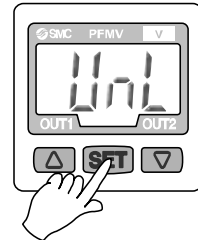

●Unlocking

1. Press the **SET** button for 5 seconds or longer in the measurement mode. [LoC] will be displayed.

2. Press the **Δ** or **▽** button to select keys unlock [UnL].

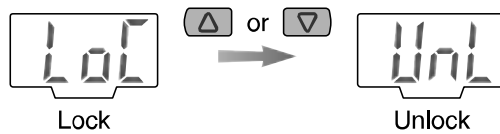

3. Press the **SET** button to store the setting and return to measurement mode.

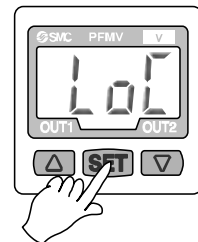

<Operation -with security code input- >

•**Locking**

1. Press the **SET** button for 5 seconds or longer in measurement mode.
[UnL] will be displayed.
2. Press the **▲** or **▼** button to select keys lock [LoC].

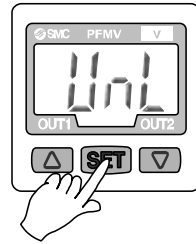
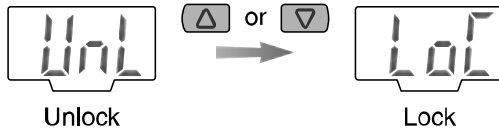

3. Press the **SET** button to store the setting and return to measurement mode.

•**Unlocking**

1. Press the **SET** button for 5 seconds or longer in measurement mode.
[LoC] will be displayed.
2. Press the **▲** or **▼** button to select keys unlock [UnL].

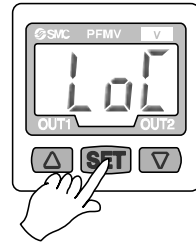
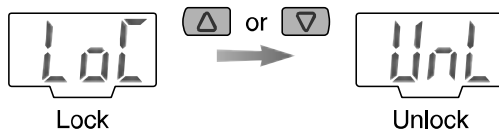

3. When the **SET** button is pressed, the security code must now be entered.

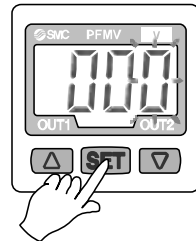

How to enter the security code

The first digit will start flashing. Press the **▲** or **▼** button to select a value.
Press the **SET** button to set, and the next digit will start flashing.
If the **SET** button is pressed at the last digit, the first digit will start flashing again.
After the setting is completed, press and hold the **SET** button for 1 second or longer.



4. If the security code entered is correct, the display will change to [UnL].
Press any of the **▲**, **SET** or **▼** buttons to release the key-lock and return to measurement mode.
If the security code entered is incorrect, [FAL] will be displayed and the security code must be entered again.
If an incorrect security code is entered three times, [LoC] is displayed and the display will return to measurement mode.

* : If a key operation is not performed for 30 seconds while entering the security code setting, the measurement mode will return.

•How to change the security code

At the time of shipment, the security code is set to [000], but this can be changed to any number.

<Operation>

1. Perform the key locking procedure, followed by the first 3 steps of the key unlocking procedure

2. When [UnL] is displayed, press the **SET** and **▽** buttons simultaneously for 5 seconds or longer.

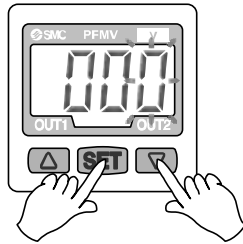

[000] is displayed and a new security code can now be entered.

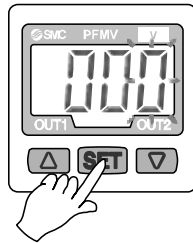

How to enter the security code

The first digit will start flashing. Press the **△** or **▽** button to select a value.

Press the **SET** button to set, and the next digit will start flashing.

If the **SET** button is pressed at the last digit, the first digit will start flashing again.

After the setting is completed, press and hold the **SET** button for 1 second or longer.



The new security code will be displayed.

At this time, if the **△** or **▽** button is pressed, any security code changes are lost, and the change of security code procedure must be repeated.

3. After checking the security code is as required, press the **SET** button.

The display will return to measurement mode.

Maintenance

How to reset the product after a power cut forcible de-energizing

The setting of the product will be retained as it was before a power cut or de-energizing.

The output condition is also basically recovered to that before a power cut or de-energizing, but may change depending on the operating environment.

Therefore, check the safety of the whole installation before operating the product.

Troubleshooting

Troubleshooting

If an operation failure occurs with the product, use the chart below to find out the cause of the problem. If none of the countermeasures seem to be applicable, or a replacement product operates normally when installed, the product may be faulty. A product can be damaged by the operating environment (system configuration etc). If the product seems to be faulty, please contact SMC.

●Faults and countermeasures

Fault	Status	Possible cause	Item to check	Countermeasure
Incorrect display	No Display	Incorrect wiring	Check that the brown and blue wires are connected to DC (+) and DC (-) respectively.	Correct the wiring.
		Connector is disconnected	Check the connectors.	Correct the connector wiring.
	Display is flashing	Peak/bottom value display mode is selected	Check if the peak value or bottom value display mode has been selected.	Refer to "Peak/bottom value display" (page 41), and remove the setting.
	Indication/voltage is not stable	Foreign matter has entered the flow passage or adhered to the sensor	(1) Check if any foreign matter has entered the flow passage. (2) Check if there is foreign matter on the mesh.	Install a filter or mist separator on the IN side.
		Mounting direction of the product and signal output direction do not match	Check that the mounting direction of the product and the analogue voltage output direction are the same as the flow direction.	Mounting direction of the product, analogue signal output direction and fluid flow direction should be the same.
		Flow is pulsing	Check if there is any supply pressure fluctuation or pressure pulsation due to the characteristics of the source compressor (or pump).	Install an accumulator tank to reduce the pressure fluctuation. Change the pressure source to one that has less pulsation.

Fault	Status	Possible cause	Item to check	Countermeasure
Incorrect display	Incorrect display	Foreign matter has entered the flow passage or adhered to the sensor	(1) Check if any foreign matter has entered the flow passage. (2) Check if there is foreign matter on the mesh.	Install a filter or mist separator on the IN side.
		Mounting direction of the product and signal output direction do not match	Check that the mounting direction of the product and the analogue voltage output direction are the same as the flow direction.	Mounting direction of the product, analogue signal output direction and fluid flow direction should be the same.
		Incorrect display mode	Check the display mode to find out if it is in the voltage monitoring state or the flow display mode.	Select the voltage monitoring display if it is used as a voltage monitor, and select the flow display function if you want it to display flow.
		Incorrect flow unit selected	Check the display unit selected.	Select the appropriate flow units. (page 39)
		Incorrect flow range selected	Check the flow range of the model used.	Select a model with the appropriate flow range. (page 38)
		Air leakage	Check for air leakage due to loose piping or insufficient sealant, etc.	Reconnect the piping with the specified tightening torque and re-apply the sealant tape.

Fault	Status	Possible cause	Item to check	Countermeasure
Incorrect output	No output	Incorrect wiring	Check that the brown, blue, black and white wires are connected correctly.	Correct the wiring.
		Connector is disconnected	Check the connectors.	Correct the connector wiring.
	Indication/voltage is not stable	Foreign matter has entered the flow passage or adhered to the sensor	(1) Check if any foreign matter has entered the flow passage. (2) Check if there is foreign matter on the mesh.	Install a filter or mist separator on the IN side.
		Mounting direction of the product and signal output direction do not match	Check that the mounting direction of the product and the analogue voltage output direction are the same as the flow direction.	Mounting direction of the product, analogue signal output direction and fluid flow direction should be the same.
		Flow is pulsing	Check if there is any supply pressure fluctuation or pressure pulsation due to the characteristics of the source compressor (or pump).	Install an accumulator tank to reduce the pressure fluctuation. Change the pressure source to one that has less pulsation.
		Air leakage	Check for air leakage due to loose piping or insufficient sealant, etc.	Reconnect the piping with the specified tightening torque and re-apply the sealant tape.
Hysteresis value too low	Check the hysteresis set value.	Increase the hysteresis set value.		
Buttons not operating	No reaction when the buttons are pressed	The keys are locked	Check if [Loc] is displayed when the buttons are pressed.	Release the key-lock function. (Refer to page 42)
External input does not operate	No reaction to the external input	Incorrect wiring	Check that the brown, blue, black and white wires are connected correctly.	Correct the wiring.
		The input signal duration is too short	Check that the white input wire is connected to GND for 5 ms or more.	For external inputs, the white wire should be connected to GND for 5 ms or more.

■ Error indication

Error Name	Display	Type	Troubleshooting
Input voltage flow error	HHH	The flow (input voltage) has exceeded the upper limit of the display range.	Reduce input voltage (= flow).
	LLL	The flow (input voltage) is less than the lower limit of the display range.	Increase input voltage (= flow).
		A sensor may be disconnected or wired incorrectly.	Check the connection and wiring of the sensor.
Over current error	Er1	The switch output load current (OUT1) has exceeded 80 mA.	Turn off the power supply and remove the cause of the over current. Then supply the power again.
	Er2	The switch output load current (OUT2) has exceeded 80 mA.	
System error	Er0	The product has lost the factory adjustment settings. The internal circuit may be damaged.	Stop operation immediately and contact SMC.
	Er3	System error. The product has failed to store the data, or the internal circuit may be damaged.	Turn the power off and turn it on again, then repeat the Function Setting.
Standard value offset error	Er4	The standard value offset function has been performed outside the effective range for correction. (page 41)	Perform the standard value offset under no flow conditions.

*: If the error cannot be reset after the above measures are taken, then please contact SMC.

Specifications

■ Specifications

Model		PFMV3□□					
Applicable sensor		PFMV505	PFMV510	PFMV530	PFMV505F	PFMV510F	PFMV530F
Voltage	Rated voltage range	1.00 to 5.00 V					
	Display voltage range Set voltage range	0.70 to 5.10 V					
	Minimum setting unit	0.01V					
Flow *1	Rated flow range	0 to 0.5 L/min	-0.05 to 1.05 L/min	0 to 3 L/min	0.5 to 0.5 L/min	-1 to -1 L/min	-3 to 3 L/min
	Display flow range Set flow range	-0.025 to 0.525 L/min	-0.05 to 1.05 L/min	-0.15 to 3.15 L/min	-0.525 to 0.525 L/min	-1.05 to 1.05 L/min	-3.15 to -3.15 L/min
	Minimum setting unit	0.001 L/mim	0.01 L/mim		0.001 L/mim	0.01 L/mim	
Indication unit		Voltage : V Instantaneous flow : L/min, CFH(ft ³ /h) *2					
Repeatability *3		Switch output: ±0.1% F.S. max., analogue output: ±0.3% F.S. max.					
Temperature characteristics		±0.5% F.S. max. (reference 25 °C)					
Switch output		NPN or PNP open collector output: 2 outputs					
	Max. load current	80 mA					
	Max. load voltage	30 VDC (at NPN output)					
	Residual voltage	1 V or less (at load current 80 mA)					
	Output protection	Short-circuit protection					
	Output mode	Hysteresis mode, window comparator mode					
	Response time □	2 ms (10 ms, 50 ms, 0.5 s, 1 s can be selected)					
	Hysteresis	Variable					
Analogue output	Voltage output	1 to 5 V Output impedance: 1 kΩ					
	Current output	4 to 20 mA Max. load impedance: 600 Ω (24 VDC)					
	Accuracy	±1%F.S. max. (relative to display value)					
	Response time	0.1 s or less					
External input		Voltage free input (reed switch or solid state), 5 ms or more					
Display accuracy *3		±0.5%F.S. max. ±1 digit					
Display		3+1/2 digits, 7 segment, dual colour display (red/green)					
Indicator LED		LED is ON when output is ON OUT1: Green OUT2: Red					
Supply voltage		12 to 24 VDC (ripple ±10% max.) (with polarity protection)					
Power consumption		50 mA or less					

Model		PFMV3□□
Environment	Enclosure	IP40
	Operating temp. range	Operating: 0 to 50 °C; stored: -10 to 60 °C (no freezing or condensation)
	Operating humidity range	Operating and stored: 35 to 85% R.H. (no condensation)
	Withstand voltage	1000 VAC for 1 min. between whole charging part and case
	Insulation resistance	50 MΩ min (500 VDC Mega) between whole charging part and case
Standards		CE, UL, CSA, RoHS
Material		Front and rear cases: PBT
Weight		30 g (without lead wire); 85 g (with lead wire)

*1: Flow in the specification is the value at standard condition.

*2: When unit selection function is equipped.

*3: When the flow indication is selected, please refer to the characteristic data for the indication accuracy of PFMV3 and each sensor.

Cable specifications (ZS-28-A)

Conductor	Nominal cross section area	approx. 0.2 mm ²
	Individual wire diameter	approx. 0.58 mm
Insulator	Outside diameter	approx. 1.12 mm
	Colours	Brown, White, Black, Grey, Blue
Sheath	Material	Oil-resistant vinyl chloride resin compound
	Outer diameter	approx. ϕ 4.1 mm

■ Characteristics data

● Analogue output characteristics

Voltage display

Analogue voltage output (1 to 5 V)

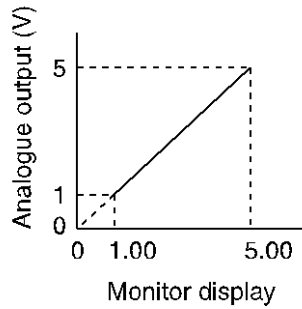

Analogue voltage output (4 to 20 mA)

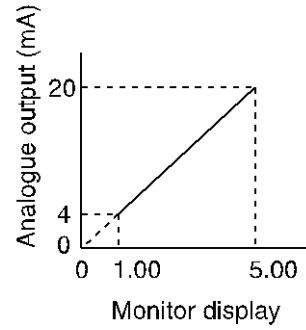

Flow display

Analogue voltage output (1 to 5 V)

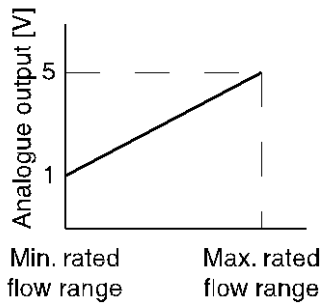

Analogue current output (4 to 20 mA)

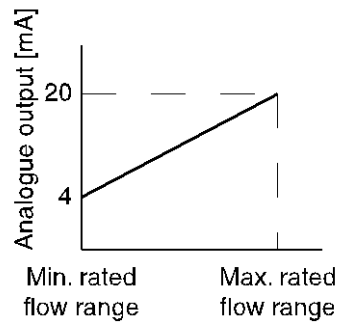

Model	Min. rated flow range	Max. rated flow range
PFMV505	0 L/min	0.5 L/min
PFMV510	0 L/min	1.0 L/min
PFMV530	0 L/min	3.0 L/min
PFMV505F	-0.5 L/min	0.5 L/min
PFMV510F	-1.0 L/min	1.0 L/min
PFMV530F	-3.0 L/min	3.0 L/min

- Display accuracy and repeatability for combination with each appropriate sensor when the flow indication is selected.

— Display accuracy
 — Repeatability accuracy

When combined with the PFMV505(F)

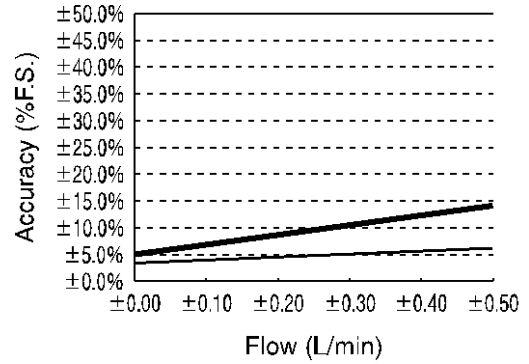

When combined with the PFMV510(F)

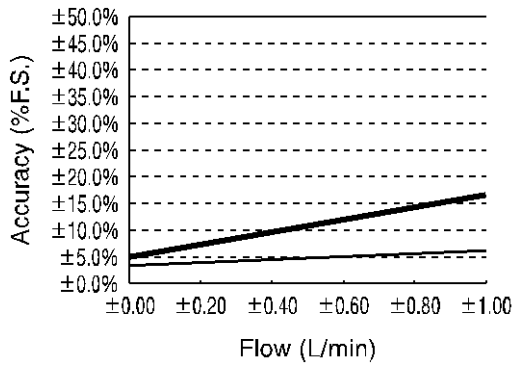

When combined with the PFMV530(F)

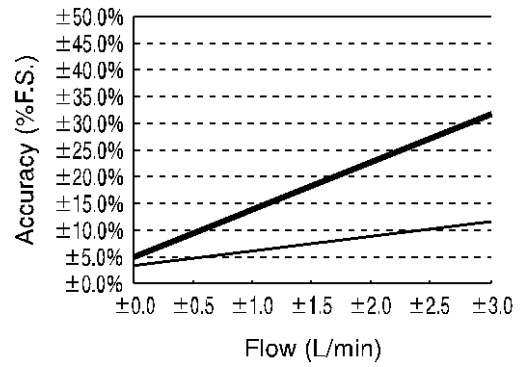

■ Dimensions (in mm)

PFMV3※※

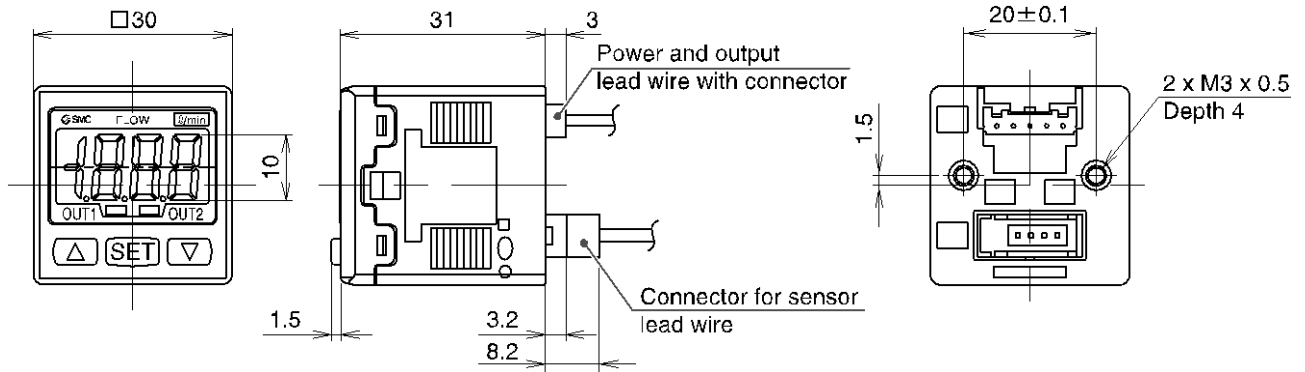

Panel cut-out dimensions Panel thickness: 0.5 to 6.0 mm

● Individual

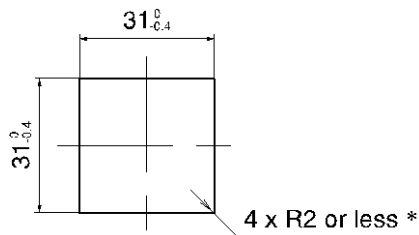

● Two or more in a row (n: The number of products)

Horizontal

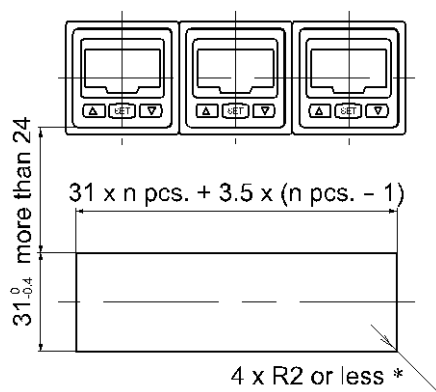

Vertical

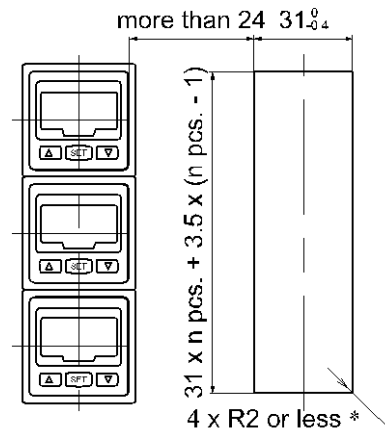

*: Ensure all corners are a maximum of R3. If a bend (R) is used, limit it to R2 or less.

Bracket (ZS-28-B)

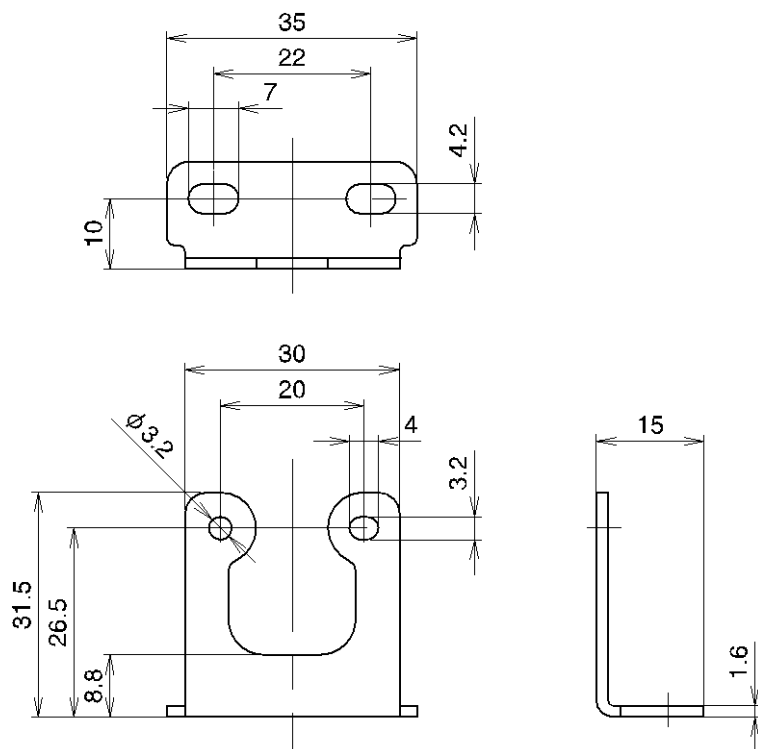

Power and output lead wire and connector (ZS-28-A)

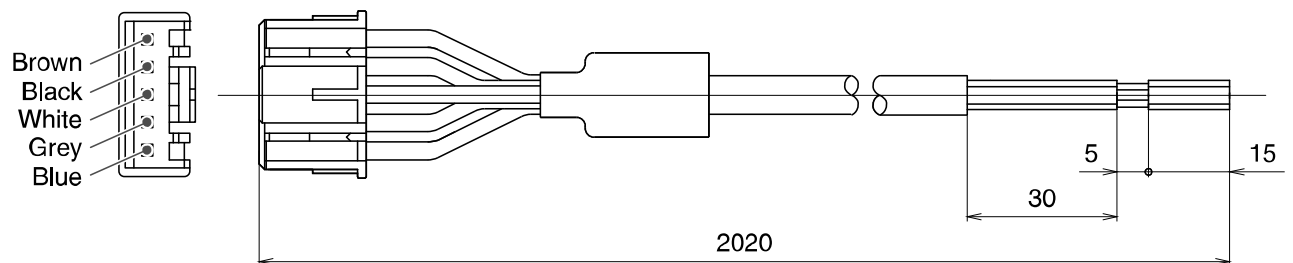

Revision history

A: Contents revised in several places.
B: Error correction. (page [28](#))
C: Contents revised in several places.
D: Contents revised in several places.
[September 2016]
E: Contents revised in several places.
[August 2018]

SMC Corporation

4-14-1, Sotokanda, Chiyoda-ku, Tokyo 101-0021 JAPAN
Tel: + 81 3 5207 8249 Fax: +81 3 5298 5362
URL <http://www.smcworld.com>

Note: Specifications are subject to change without prior notice and any obligation on the part of the manufacturer.
© 2011-2018 SMC Corporation All Rights Reserved

