

Before Use

Digital Flow Switch

PF3WB/C/S/R Series



Thank you for purchasing an SMC PF3WB/C/S/R Series Digital Flow Switch. Please read this manual carefully before operating the product and make sure you understand its capabilities and limitations. Please keep this manual handy for future reference.

To obtain the operation manual about this product, please refer to the SMC website (URL <https://www.smcworld.com>) or contact SMC directly.

Safety Instructions

These safety instructions are intended to prevent hazardous situations and/or equipment damage. These instructions indicate the level of potential hazard with the labels of "Caution", "Warning" or "Danger". They are all important notes for safety and must be followed in addition to International standards (ISO/IEC) and other safety regulations.

- Caution:** CAUTION indicates a hazard with a low level of risk which, if not avoided, could result in minor or moderate injury.
- Warning:** WARNING indicates a hazard with a medium level of risk which, if not avoided, could result in death or serious injury.
- Danger:** DANGER indicates a hazard with a high level of risk which, if not avoided, will result in death or serious injury.

Operator

- ◆ The operation manual is intended for those who have knowledge of machinery using pneumatic equipment, and have sufficient knowledge of assembly, operation and maintenance of such equipment. Only those persons are allowed to perform assembly, operation and maintenance.
- ◆ Read and understand the operation manual carefully before assembling, operating or providing maintenance to the product.

Safety Instructions

Warning

- Do not disassemble, modify (including changing the printed circuit board) or repair. An injury or failure can result.
- Do not operate the product outside of the specifications. Do not use for flammable or harmful fluids. Fire, malfunction, or damage to the product can result. Verify the specifications before use.
- Do not operate in an atmosphere containing flammable or explosive gases. Fire or an explosion can result. This product is not designed to be explosion proof.
- Do not use with flammable or highly permeable fluids. Fire, explosion, damage or corrosion can result.
- Do not use the product in a place where static electricity is a problem. Otherwise it can cause failure or malfunction of the system.
- If using the product in an interlocking circuit:
 - Provide a double interlocking system, for example a mechanical system
 - Check the product regularly for proper operation
 Otherwise malfunction can result, causing an accident.
- The following instructions must be followed during maintenance:
 - Turn off the power supply
 - Ensure the flow is shut off before performing maintenance
 Otherwise an injury can result.

Caution

- Do not touch the terminals and connectors while the power is on. Otherwise electric shock, malfunction or damage to the product can result.
- Do not touch the piping or its connected parts when the fluid is at high temperature. It may lead to burn. Ensure the piping cools sufficiently before touching.
- After maintenance is complete, perform appropriate functional inspections and leak tests. Stop operation if the equipment does not function properly or there is a leakage of fluid. When leakage occurs from parts other than the piping, the product might be faulty. Disconnect the power supply and stop fluid supply. Do not apply fluid under leaking conditions. Safety cannot be assured in the case of unexpected malfunction.

Summary of Product parts

The figure below is the PF3WB series. The summary of product parts of the PF3WC/S/R series do not change.

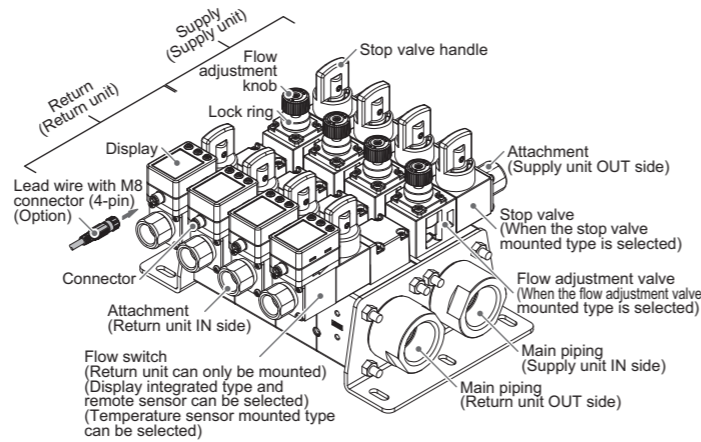

Element	Description
Supply (Supply unit)	This unit supplies the fluid from the supply side main piping to the application. Flow adjustment valve and stop valve can be combined to compose the of the equipment. *: The supply unit is not suitable for the flow switch.
Return (Return unit)	This unit returns the fluid exhausted from the application. Flow adjustment valve and stop valve can be combined to compose the of the equipment.
Flow switch	This switch displays or outputs the flow rate when flow is applied. *: Applicable to integrated display type/remote sensor type. (Temp. sensor mounted type can be selected) *: IO-Link compatible (Integrated display type only) *: Cannot be used for the supply unit.
Display	For the integrated display type, it displays flow rate, set value and errors. For the remote type, POWER indicator and FLOW indicator are mounted. For display, refer to Operation Manual from the SMC website. (Display integrated type: PF3W7, remote sensor type sensor: PF3W5)
Connector	This connects the lead wires. As for the connector pin numbers (on the product), refer to Operation Manual from the SMC website. (Display integrated type: PF3W7, remote sensor type sensor: PF3W5)
Lead wire with M8 connector	Lead wire for supply power to and obtaining output from the flow switch
Flow adjustment valve	Orifice mechanism to adjust the flow rate. *: This flow adjustment valve is not suitable for applications which require constant adjustment of flow rate. *: This product is not suitable for stopping the flow rate. *: Applicable to supply/return unit.
Flow adjustment knob	This knob is for adjusting the flow rate.
Lock ring	This is used for holding the flow adjustment valve.
Stop valve	This is the mechanism part for stopping the flow rate. *: Not suitable for adjusting the flow rate. *: Applicable to supply/return unit.
Stop valve handle	This handle is for stopping the flow rate. When the handle is rotated by 90°, it is possible to stop the flow rate.
Attachment	This connects the piping of the supply/return units.
Main piping	This connects the piping of the manifold body. Open or close cannot be selected. *: PF3WC series is not applicable to "Close". *: It is not possible to change the main piping after order.

Mounting and Installation

Refer to the product catalogue or SMC website (URL <https://www.smcworld.com>) for more detailed information.

Installation

- Use the product within the specified operating pressure and temperature range.
- Proof pressure could vary according to the fluid temperature. Check the characteristics data for operating pressure and proof pressure.

Mounting

- Never mount the product in a place that will be used as a scaffold during piping.
- Mount the product so that the fluid flows in the direction indicated by the arrow on the side of the flow switch.
- Check the flow characteristics data for pressure loss and the straight inlet pipe length effect on accuracy, to determine inlet piping requirements.
- Do not sharply reduce the piping size.
- The monitor with integrated display can be rotated. It can be set at 90° intervals clock and anticlockwise, and also at 45° and 225° clockwise. Rotating the display with excessive force will damage the end stop.
- When the stop valve is mounted, rotate the monitor after closing the stop valve handle. Rotating the monitor with excessive force while opening the stop valve handle, the monitor and stop valve will be interfered with each other, which may damage them. (Refer to the figure below)

Integrated display type Monitor rotation diagram

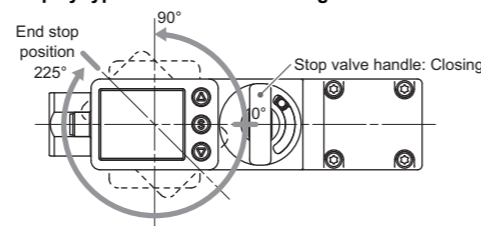

Installation

Direct mounting

- When mounting the product, mount it to the main piping with screws using the mounting holes (equivalent to M6).
- Mounting plate thickness is approximately 3 mm.
- Screws and nuts are prepared by the user.

Product number	Manifold type	Qty
PF3WB	Integrated type: Basic type	6
PF3WC	Integrated type: Straight type	4
PF3WS	Remote type: Supply type	4
PF3WR	Remote type: Return type	4

Refer to the outline dimension drawing for mounting hole size. Refer to the product catalogue or SMC website (URL <https://www.smcworld.com>) for more detailed information.

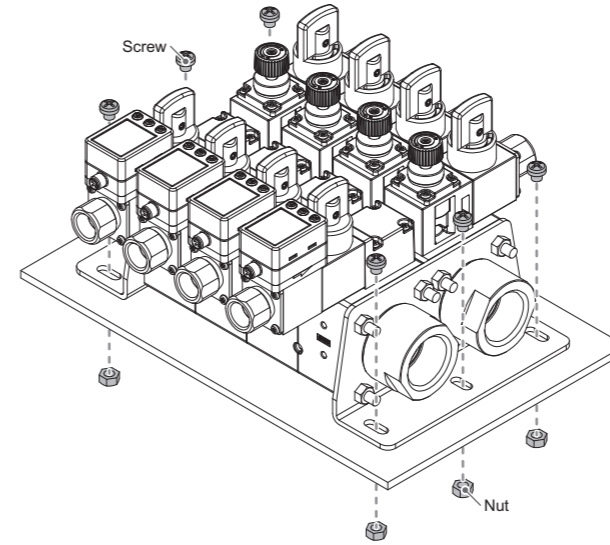

Piping

For piping of the product, hold the piping with a wrench on the metal part of the piping (piping attachment and main port of the main piping), which is integrated to the piping. Use a wrench on other parts may damage the product. Specifically, make sure that the spanner does not damage the M8 connector. The connector can be easily damaged.

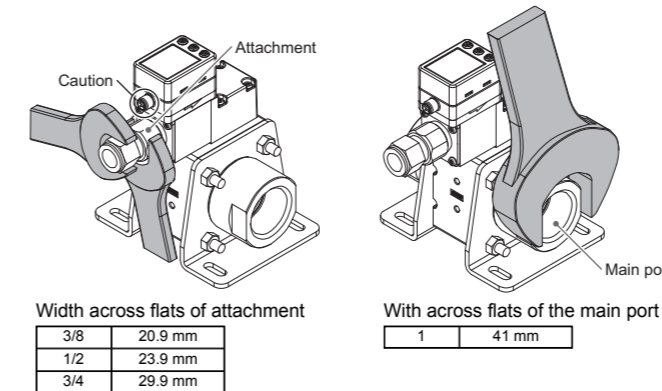

After hand tightening, tighten the hexagon head bolt 2 to 3 rotations by using a spanner. Refer to the table below for the tightening torque.

Nominal thread size	Tightening torque
Rc(NPT)3/8	15 to 20 Nm
Rc(NPT)1/2	20 to 25 Nm
Rc(NPT)3/4	28 to 30 Nm
Rc(NPT)1	36 to 38 Nm

If the tightening torque is exceeded, the product can be broken. If the correct tightening torque is not applied, the fittings may become loose.

Avoid any sealing tape getting inside the piping. Ensure there is no leakage from loose piping.

How to adjust the flow rate (when a flow adjustment valve is mounted)

- (1) Rotate the knob of the valve to adjust the flow rate to the target value.
- (2) Be sure to confirm that there is no fluid leakage generated after adjustment. (When fluid leakage is generated, open and close the valve several times for re-adjustment, and confirm that there is no fluid leakage.)
- (3) Tighten the lock ring to fix the valve as necessary.

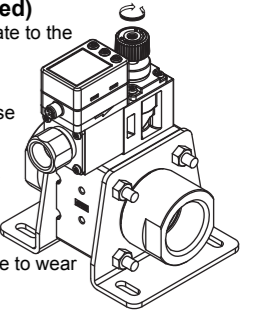

The flow adjustment valve is not designed for applications that require daily and repetitive adjustment. If the valve is adjusted frequently, fluid may leak due to wear of the internal seal.

How to stop the flow (for stop valve)

- (1) Rotate the handle by 90° to stop the flow.
- (2) Check that there is no water leakage after stopping the flow.
- (3) When holding the handle, screws need to be prepared by the user. Refer to the table below for the applicable size and tightening torque.

Flow range	Applicable screws	Tightening torque
04	Equivalent to M3 (L=6)	0.04 to 0.05 Nm
20		
40	Equivalent to M4 (L=10)	0.09 to 0.10 Nm

When closing and opening are repeated frequently, water leakage may occur due to wear of the internal seals.

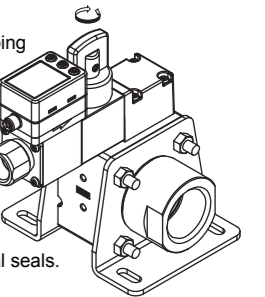

Wiring

Wiring of connector

Connections should only be made with the power supply turned off. Use separate routes for the Flow switch wiring and any power or high voltage wiring. Otherwise, malfunction may result due to noise. Ensure that the FG terminal is connected to ground when using a commercially available switch-mode power supply. When a switch-mode power supply is connected to the product, switching noise will be superimposed and the product specification can no longer be met. This can be prevented by inserting a noise filter, such as a line noise filter and ferrite core, between the switch-mode power supply and the product, or by using a series power supply instead of a switch-mode power supply.

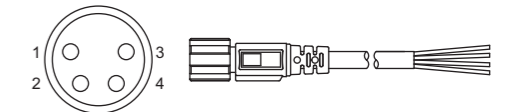

Integrated display type (PF3W7)/Remote type sensor (PF3W5)

Pin No	Integrated display type (PF3W7)	Remote type sensor (PF3W5)	Lead wire colour
1	DC(+)	DC(+)	Brown
2	OUT2	N.C./temp. analogue output	White
3	DC(-)	DC(-)	Blue
4	OUT1	Flow rate analogue output	Black

When PF3W7 (IO-Link) is used

•SIO mode setting

Pin No	Name	Lead wire colour	Function
1	DC(+)	Brown	12 to 24 VDC
2	N.C./OUT2	White	Not connected/Switch output 2 (SIO)
3	DC(-)	Blue	0 V
4	OUT1	Black	Switch output 1

•IO-Link mode setting

Pin No	Name	Lead wire colour	Function
1	L+	Brown	18 to 30 VDC
2	N.C./OUT2	White	Not connected/Switch output 2 (SIO)
3	L-	Blue	0 V
4	C/Q	Black	Communication data (IO-Link)/Switch output 1 (SIO)

※ When using the lead wire with M8 connector included with the PF3W7 series.

Tighten the connector by hand.

Maintenance

How to reset the product after a power cut or forcible de-energizing

When the flow switch is the integrated display type, the condition before the power cut will be remained. The output condition also recovers to that before the power cut or de-energizing, but may change depending on the operating environment. Therefore, check the safety of the whole system before operating the product.

Specifications

Refer to the product catalogue or SMC website (URL <https://www.smcworld.com>) for more information about the product specifications.

Dimensions

Refer to the product catalogue or SMC website (URL <https://www.smcworld.com>) for more information about the dimensions.

SMC Corporation

URL <https://www.smcworld.com>
 Akihabara UDX 15F, 4-14-1, Sotokanda, Chiyoda-ku, Tokyo 101-0021, JAPAN
 Phone: +81 3-5207-8249 Fax: +81 3-5298-5362

Note: Specifications are subject to change without prior notice and any obligation on the part of the manufacturer.
 © 2019 SMC Corporation All Rights Reserved PF-000005-A