



# Operation Manual

PRODUCT NAME

Digital Flow Switch

MODEL / Series / Product Number

*PFMB7501*

*PFMB7102*

*PFMB7202*

**SMC Corporation**

# Contents

Safety Instructions	2
Model Indication and How to Order	10
Summary of Product parts	11
Definition and terminology	12
Mounting and Installation	14
Installation	14
Piping	16
Wiring	17
Outline of Settings [Measurement mode]	21
Flow Setting (set value only) of OUT1 · OUT2 [3 step setting mode]	22
Default settings	22
Function Setting [Function selection mode]	24
Default settings	25
F0 Reference condition/Unit selection function	26
F1 Setting of OUT1	28
F2 Setting of OUT2	36
F3 Response time	41
F10 Display mode	42
F13 Reversed display mode	43
F20 External input	44
F22 Setting of analogue output	45
F30 Accumulated value hold	46
F31 Orientation correction function	47
F80 Display OFF mode	48
F81 Security code	49
F90 Setting of all functions	50
F98 Output check	52
F99 Reset to the default settings	53
Other Functions	54
Maintenance	58
Troubleshooting	59
Error indication	61
Specification	62
Specifications	62
Characteristics data	65
Dimensions	67



# Safety Instructions

These safety instructions are intended to prevent hazardous situations and/or equipment damage. These instructions indicate the level of potential hazard with the labels of "Caution", "Warning" or "Danger". They are all important notes for safety and must be followed in addition to International Standards (ISO/IEC)\*1), and other safety regulations.

\*1) ISO 4414: Pneumatic fluid power -- General rules relating to systems.

ISO 4413: Hydraulic fluid power -- General rules relating to systems.

IEC 60204-1: Safety of machinery -- Electrical equipment of machines .(Part 1: General requirements)

ISO 10218: Manipulating industrial robots -Safety.

etc.



## Caution

**Caution** indicates a hazard with a low level of risk which, if not avoided, could result in minor or moderate injury.



## Warning

**Warning** indicates a hazard with a medium level of risk which, if not avoided, could result in death or serious injury.



## Danger

**Danger** indicates a hazard with a high level of risk which, if not avoided, will result in death or serious injury.

## Warning

### 1. The compatibility of the product is the responsibility of the person who designs the equipment or decides its specifications.

Since the product specified here is used under various operating conditions, its compatibility with specific equipment must be decided by the person who designs the equipment or decides its specifications based on necessary analysis and test results.

The expected performance and safety assurance of the equipment will be the responsibility of the person who has determined its compatibility with the product.

This person should also continuously review all specifications of the product referring to its latest catalog information, with a view to giving due consideration to any possibility of equipment failure when configuring the equipment.

### 2. Only personnel with appropriate training should operate machinery and equipment.

The product specified here may become unsafe if handled incorrectly.

The assembly, operation and maintenance of machines or equipment including our products must be performed by an operator who is appropriately trained and experienced.

### 3. Do not service or attempt to remove product and machinery/equipment until safety is confirmed.

1. The inspection and maintenance of machinery/equipment should only be performed after measures to prevent falling or runaway of the driven objects have been confirmed.

2. When the product is to be removed, confirm that the safety measures as mentioned above are implemented and the power from any appropriate source is cut, and read and understand the specific product precautions of all relevant products carefully.

3. Before machinery/equipment is restarted, take measures to prevent unexpected operation and malfunction.

### 4. Contact SMC beforehand and take special consideration of safety measures if the product is to be used in any of the following conditions.

1. Conditions and environments outside of the given specifications, or use outdoors or in a place exposed to direct sunlight.

2. Installation on equipment in conjunction with atomic energy, railways, air navigation, space, shipping, vehicles, military, medical treatment, combustion and recreation, or equipment in contact with food and beverages, emergency stop circuits, clutch and brake circuits in press applications, safety equipment or other applications unsuitable for the standard specifications described in the product catalog.

3. An application which could have negative effects on people, property, or animals requiring special safety analysis.

4. Use in an interlock circuit, which requires the provision of double interlock for possible failure by using a mechanical protective function, and periodical checks to confirm proper operation.



# Safety Instructions

## Caution

### **1. The product is provided for use in manufacturing industries.**

The product herein described is basically provided for peaceful use in manufacturing industries. If considering using the product in other industries, consult SMC beforehand and exchange specifications or a contract if necessary.  
If anything is unclear, contact your nearest sales branch.

## **Limited warranty and Disclaimer/Compliance Requirements**

The product used is subject to the following "Limited warranty and Disclaimer" and "Compliance Requirements".

Read and accept them before using the product.

### **Limited warranty and Disclaimer**

#### **1. The warranty period of the product is 1 year in service or 1.5 years after the product is delivered, whichever is first.\*2)**

Also, the product may have specified durability, running distance or replacement parts. Please consult your nearest sales branch.

#### **2. For any failure or damage reported within the warranty period which is clearly our responsibility, a replacement product or necessary parts will be provided.**

This limited warranty applies only to our product independently, and not to any other damage incurred due to the failure of the product.

#### **3. Prior to using SMC products, please read and understand the warranty terms and disclaimers noted in the specified catalog for the particular products.**

##### **\*2) Vacuum pads are excluded from this 1 year warranty.**

A vacuum pad is a consumable part, so it is warranted for a year after it is delivered.

Also, even within the warranty period, the wear of a product due to the use of the vacuum pad or failure due to the deterioration of rubber material are not covered by the limited warranty.

### **Compliance Requirements**

#### **1. The use of SMC products with production equipment for the manufacture of weapons of mass destruction (WMD) or any other weapon is strictly prohibited.**

#### **2. The exports of SMC products or technology from one country to another are governed by the relevant security laws and regulation of the countries involved in the transaction. Prior to the shipment of a SMC product to another country, assure that all local rules governing that export are known and followed.**

## Caution

### **SMC products are not intended for use as instruments for legal metrology.**

Products that SMC manufactures or sells are not measurement instruments that are qualified by pattern approval tests relating to the measurement laws of each country.

Therefore, SMC products cannot be used for business or certification ordained by the measurement laws of each country.

## Operator

- ◆ This operation manual is intended for those who have knowledge of machinery using pneumatic equipment, and have sufficient knowledge of assembly, operation and maintenance of such equipment. Only those persons are allowed to perform assembly, operation and maintenance.
- ◆ Read and understand this operation manual carefully before assembling, operating or providing maintenance to the product.

### ■ Safety Instructions

#### **Warning**

- Do not disassemble, modify (including changing the printed circuit board) or repair.  
An injury or failure can result.
- Do not operate the product outside of the specifications.  
Do not use for flammable or harmful fluids.  
Fire, malfunction, or damage to the product can result.  
Verify the specifications before use.
- Do not operate in an atmosphere containing flammable, explosive or corrosive gas.  
Fire, explosion or corrosion can result.  
This product is not designed to be explosion proof.
- Do not use the product for flammable fluid.  
Fire or explosion can result.  
Only air and N<sub>2</sub> are applicable.
- Do not use the product in a place where static electricity is a problem.  
Otherwise it can cause failure or malfunction of the system.
- If using the product in an interlocking circuit:
  - Provide a double interlocking system, for example a mechanical system
  - Check the product regularly for proper operationOtherwise malfunction can result, causing an accident.
- The following instructions must be followed during maintenance:
  - Turn off the power supply
  - Stop the air supply, exhaust the residual pressure and verify that the air is released before performing maintenance workOtherwise an injury can result.

## Caution

- Do not touch the terminals and connectors while the power is on.  
Otherwise electric shock, malfunction or damage to the product can result.
- After maintenance is complete, perform appropriate functional inspections and leak tests.  
Stop operation if the equipment does not function properly or there is a leakage of fluid.  
When leakage occurs from parts other than the piping, the product might be faulty.  
Disconnect the power supply and stop the fluid supply.  
Do not apply fluid under leaking conditions.  
Safety cannot be assured in the case of unexpected malfunction.

### ■ NOTE

- Follow the instructions given below when designing, selecting and handling the product.
  - The instructions on design and selection (installation, wiring, environment, adjustment, operation, maintenance, etc.) described below must also be followed.
  - \* Product specifications
    - Use the specified voltage.  
Otherwise failure or malfunction can result.  
Insufficient supply voltage may not drive a load due to a voltage drop inside the product.  
Verify the operating voltage of the load before use.
    - Do not exceed the specified maximum allowable load.  
Otherwise it can cause damage or shorten the lifetime of the product.
    - Data stored by the product is not deleted, even if the power supply is cut off.  
(Writing time: 1000000 cycles)
    - The applicable fluids are dry air and Nitrogen.  
The fluid temperature range is 0 to 50 °C.
    - Before designing piping confirm the pressure loss at the sensor from the pressure loss graph.  
(characteristics data).
    - For the details of compressed air quality, refer to ISO 8573-1, 1.1.2 to 1.6.2.
    - Use the specified measurement flow rate and operating pressure.  
Otherwise it can cause damage to the product or inability to measure correctly.
    - Reserve a space for maintenance.  
Allow sufficient space for maintenance when designing the system.

● **Product handling**

\* **Installation**

- **Tighten to the specified tightening torque.**

If the tightening torque is exceeded the mounting screws, the product may be damaged.

If the tightening torque is insufficient, the product may be displaced and the mounting screws may come loose.

- **Ensure that the FG terminal is connected to ground when using a commercially available switch-mode power supply.**
- **Do not drop, hit or apply excessive shock to the product.**  
Otherwise damage to the internal parts can result, causing malfunction.
- **Do not pull the lead wire forcefully, or lift the product by the lead wire. (Tensile force 49 N or less)**  
Hold the product body when handling, to prevent damage, failure or malfunction.
- **For piping of the product, hold the piping with a wrench on the metal part (attachment) of the product.**  
Holding other parts with a wrench leads to may damage the product.
- **Any dust left in the piping should be flushed out by air blow before connecting the piping to the product.**  
Otherwise damage or malfunction can result.
- **Refer to the flow direction of the fluid indicated on the product label for installation and piping.**
- **Do not mount the body with the bottom facing upwards.**  
Retention of air can cause inability to measure accurately.
- **Do not insert metal wires or other foreign matter into the piping port.**  
This can damage the sensor causing failure or malfunction.
- **Never mount a product in a location that will be used as a foothold.**  
The product may be damaged if excessive force is applied by stepping or climbing onto it.
- **If there is a risk of foreign matter entering the fluid, install and pipe a filter or the mist separator at the inlet to avoid failure and malfunction.**  
Otherwise failure or malfunction can result, and it can cause inability to measure accurately.

It is possible to satisfy the air quality class indicated in the specification using the pneumatic circuit below.

**Recommended pneumatic circuit example (Compressed air)**

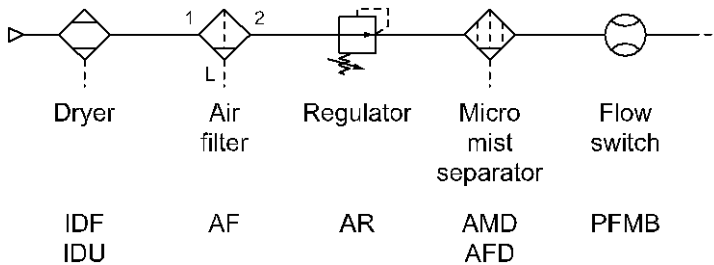

#### \*Wiring

- Do not pull the lead wires. In particular, never lift a product equipped with fitting and piping by holding the lead wires.

Otherwise damage to the internal parts can result, causing malfunction or disconnection of the connector.

- Avoid repeatedly bending or stretching the lead wire, or placing heavy loads on it.

Repeated bending stress or tensile stress can cause damage to the sheath, or breakage of the wires.

If the lead wire can move, fix it near the body of the product.

The recommended bend radius of the lead wire is 6 times the outside diameter of the sheath, or 33 times the outside diameter of the wire insulation material, whichever is larger.

Replace any damaged lead wire with a new one.

- Wire correctly.

Incorrect wiring can damage the product.

- Do not perform wiring while the power is on.

Otherwise damage to the internal parts can result, causing malfunction.

- Do not route wires and cables together with power or high voltage cables.

Otherwise the product can malfunction due to interference or noise and surge voltage from power and high voltage cables.

- Confirm proper insulation of wiring.

Poor insulation (interference from another circuit, poor insulation between terminals, etc.) can lead to excess voltage or current being applied to the product, causing damage.

- Keep wiring as short as possible to prevent interference from electromagnetic noise and surge voltage.

Do not use a cable longer than 30 m.

Wire the DC (-) line (blue) as close as possible to the power supply.

- When analogue output is used, install a noise filter (line noise filter, ferrite element, etc.) between the switch-mode power supply and this product.



#### \*Environment

- Do not use the product in an area that is exposed to water or steam.  
Otherwise it can cause failure or malfunction.
- Do not use the product in area that is exposed to oil, coolant, cleaning, solvent, sea water or chemicals.  
Otherwise it can cause adverse effects (damage, failure, malfunction, or hardening of the lead wire, etc).
- Do not use the product in an area where electrical surges are generated.  
If there is equipment generates large electrical surges (solenoid type lifter, high frequency induction furnace, motor, etc.) close to the product, damage or failure of the internal circuit may occur. Take measures against the surge sources, and prevent the wires from coming into close contact.
- Do not use a load which generates a surge voltage.  
When a surge-generating load such as a relay or solenoid is driven directly, use a product with a built-in surge absorbing element.
- The product is CE marked, but not immune to lightning strikes. Take measures against lightning strikes in the system.
- Do not use the product in areas that are exposed to vibration or impact.  
Otherwise failure or malfunction can result.
- Do not use the product in the presence of a magnetic field.  
This may lead to the malfunction of the product.
- Prevent foreign matter such as wire debris from entering the product.  
Otherwise failure or malfunction can result.
- Do not use the product in areas subject to large temperature cycle.  
Heating/cooling cycles other than ordinary changes in temperature can adversely affect the internal structure of the product.
- Do not expose the product to direct sunlight.  
If using in a location directly exposed to sunlight, use a suitable protective cover.  
Otherwise failure or malfunction can result.
- Keep within the operating temperatures range.  
The operating temperature range is 0 to 50 °C.  
Operation below the minimum temperature limit may cause damage or operation failure due to frozen moisture in the fluid or air.  
Protection against freezing is necessary.  
An air dryer is recommended for elimination of drainage and water.  
Avoid sudden temperature changes even within the specified temperature range.
- Do not operate close to a heat source, or in a location exposed to radiant heat.  
Otherwise malfunction can result.

#### \*Adjustment and Operation

- Connect load before turning on the power.

- Do not short-circuit the load.

Although an error is displayed when the product load is short circuited, excess current may cause damage to the product.

- Do not press the setting buttons with a sharp pointed object.

This may damage the setting buttons.

- Supply the power when there is no flow.

- If using the product to detect very small flow rates, warm up the product for 10 to 15 minutes first.

There will be a drift on the display or the analogue output of approximate  $\pm 2$  to 3% immediately after the power supply is turn on, within 10 minutes.

- The output is off for 3 seconds after power is supplied.

- Use settings suitable for the operating conditions.

Incorrect settings can cause operational failure.

- During the initial setting and any subsequent flow rate setting, the product will switch the output according to the existing settings until the changes are complete.

Confirm the output has no adverse effect on machinery and equipment before setting.

Stop the control system before setting if necessary.

- Do not touch the LCD display during operation.

The display can vary due to static electricity.

#### \*Maintenance

- Perform regular maintenance and inspections.

There is a risk of unexpected malfunction of components due to the malfunction of equipment and machinery.

- Turn off the power supply, stop the supplied air, exhaust the residual pressure and verify the release of air before performing maintenance.

There is a risk of unexpected malfunction.

- Perform drainage regularly.

If condensate enters the outside, it can cause failure of other pneumatic equipment.

- Do not use solvents such as benzene, thinner etc. to clean the product.

They could damage the surface of the body and erase the markings on the body.

Use a soft cloth to remove stains.

For heavy stains, use a cloth lightly dampened with diluted neutral detergent, then wipe up any residue with a dry cloth.

# Model Indication and How to Order

PFMB 7  -   -

Type

Symbol	Type
7	Integrated display type

Rated flow range

Symbol	Content
501	5 to 500 L/min
102	10 to 1000 L/min
202	20 to 2000 L/min

Thread type

Symbol	Content
Nil	Rc
N	NPT
F	G *1

\*1: ISO228 compliant.

Port size

Symbol	Size	Rated flow range		
		501	102	202
04	1/2	●	●	-
06	3/4	-	-	●

Output specification

Symbol	OUT1	OUT2
A	NPN	NPN
B	PNP	PNP
C	NPN	Analogue (1 to 5 V)
D	NPN	Analogue (4 to 20 mA)
E *2	PNP	Analogue (1 to 5 V)
F *2	PNP	Analogue (4 to 20 mA)
G *2	NPN	External input *3
H *2	PNP	External input *3

\*2: Made to Order.

\*3: Accumulated flow external reset or peak/bottom external reset are selectable.

Calibration certificate

Symbol	Content
Nil	Without calibration certificate
A	With calibration certificate *8

\*8: Made to Order.  
Certificate in both Japanese and English.

Option 2

Symbol	Content
Nil	No bracket
R	With bracket *7

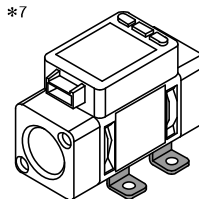

\*7: Each accessory is not assembled with the product, but shipped together.

Unit specification

Symbol	Content
Nil	Unit selection function *5
M	SI unit only *6

\*5: Since the unit for Japan is fixed to SI due to new measurement law, this option is for overseas.

\*6: Fixed unit Instantaneous flow: L/min, Accumulated flow: L

Option 1

Nil	With lead wire with connector (2 m) *4
Nil	With lead wire with connector (2 m) *4 + Connector cover (Silicone rubber)
N	No lead wire

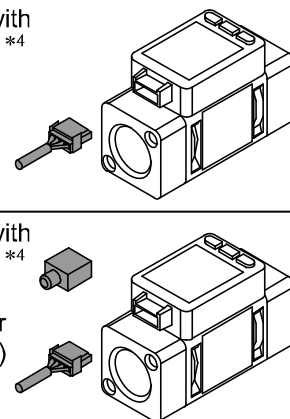

\*4: Each accessory is not assembled with the product, but shipped together.

## Accessories/Part numbers

If an accessory is required, order using the following part number.

Part number	Description	Note
ZS-33-D	Lead wire with connector	Length: 2 m
ZS-33-F	Connector cover 	Silicone rubber
ZS-42-C	Bracket	With mounting screws for PFMB7501/7102 (4 pcs. with nominal diameter of 3.0)
ZS-42-D	Bracket	With mounting screws for PFMB7202 (4 pcs. with nominal diameter of 3.0)

# Summary of Product parts

## Body

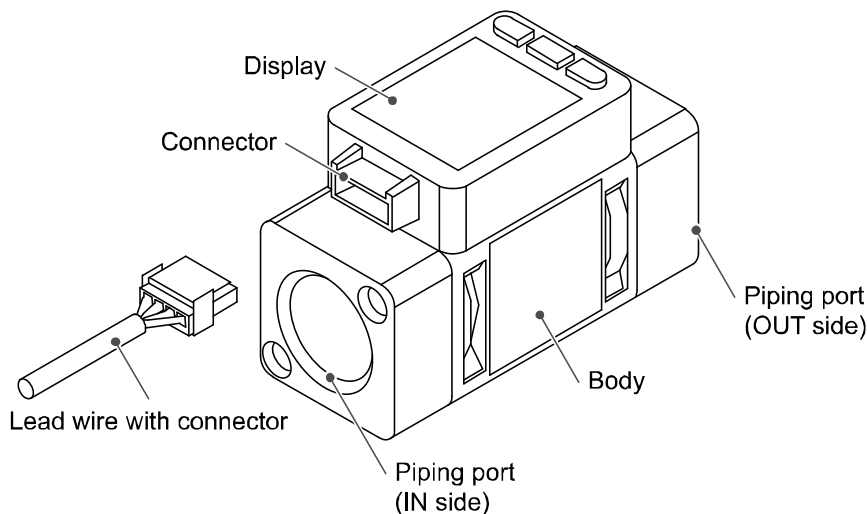

Name	Description
Display *1	See below.
Connector	Connector for electrical connections.
Lead wire with connector	Lead wire for power supply and outputs.
Piping port	For piping connections. Connected to the fluid inlet at IN and to the fluid outlet at OUT.
Body	The body of the product.

\*1: A protective tape is affixed to the display. Please remove it before use.

## Display

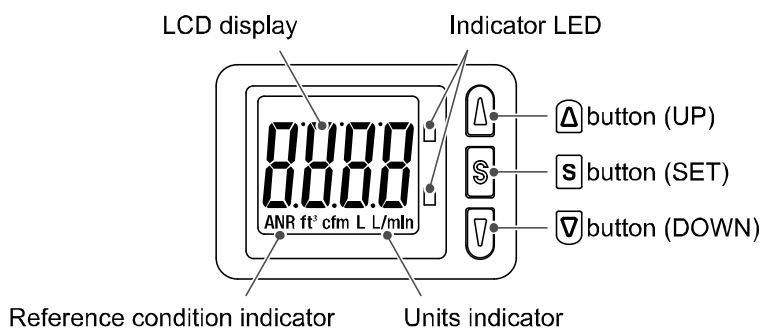

Name	Description
LCD display	Displays the flow value, setting mode and error codes.
Indicator LED	Displays the output status of OUT1 and OUT2. LED is ON (Orange) when the output is ON. When the accumulated pulse output mode is selected, the LED will turn OFF.
Δ button (UP) *2	Selects the mode and increases the ON/OFF set value. Press this button to change to the peak display mode.
S Button (SET)	Press this button to change the mode and to set a value.
▽ Button (DOWN) *2	Selects the mode and decreases the ON/OFF set value. Press this button to change to the bottom display mode.
Unit indicator	Indicates the unit currently selected.
Reference condition indicator	Indicates the reference condition selected. LED is ON (red) when standard condition is selected.

\*2: When the reversed display is used, the function of the Δ and ▽ buttons is reversed.

## ■ Definition and terminology

	Terminology	Definition
A	Accumulated flow	The total amount of fluid that has passed through the device. If an instantaneous flow of 10 L/min continues for 5 minutes, the accumulated flow will be $5 \times 10 = 50$ L.
	Accumulated flow external reset	A function to reset the accumulated flow to "0" when an external signal is input.
	Accumulated pulse output	A type of output where a pulse is generated every time a predefined accumulated flow passes. It is possible to calculate the total accumulated flow by counting the pulses.
	Accumulated value Hold	A function to store the accumulated flow value in the internal memory. The flow value will be stored at a set time interval of either 2 or 5 minutes. When the power supply is turned on, the stored accumulated flow value will be displayed and accumulated flow will continue from that point.
	Analogue output	A type of variable output that has a value proportional to the measured quantity. When the analogue output is in the range of 1 to 5 V or 4 to 20 mA, it will vary continuously, following the change of flow.
	Attachment	A metal part on both sides of the product to connect piping.
C	Chattering	The problem of the switch output turning ON and OFF repeatedly around the set value at high frequency due to the effect of pulsation.
D	Display flow range	The range which can be displayed by the product with a digital display.
F	F.S. (Full span, Full scale)	Stands for "full span" or "full scale", and indicates varied analogue output range at rated value. For example, when analogue output is 1 to 5 V, $F.S. = 5[V] - 1[V] = 4[V]$ , (ref. $1\%F.S. = 4[V] \times 1\% = 0.04[V]$ ) The maximum measuring range or change in analogue output over the maximum measurement range.
H	Hysteresis	The difference between ON and OFF points used to prevent chattering. Hysteresis can be effective in avoiding the effects of pulsation.
	Hysteresis mode	Mode where the switch output will turn ON when the flow is greater than the set value, and will turn OFF when the flow falls below the set value by the amount of hysteresis or more.
I	Instantaneous flow	The volume of flow per unit of time. If it is 10 L/min, there is a flow of 10 L passing through the device in 1 minute.
	Internal voltage drop	The voltage drop across the product (and therefore not applied to the load), when the switch output is ON. The voltage drop will vary with load current, and ideally should be 0 V.
K	Key-lock function	A function that locks the set buttons so that no accidental setting changes can be made.

	Terminology	Definition
M	Minimum setting unit	The resolution of set and display values. If the minimum setting unit is 1 L/min, the flow can be displayed in 1 L/min units, i.e. 10, 11, 12.
O	Operating fluid temperature	The fluid temperature range within which the product will meet all published specifications.
	Operating humidity range	The ambient humidity range within which the product will meet all published specifications.
	Operating pressure range	The pressure range within which the product will meet all published specifications.
	Operating temperature range	The ambient temperature range within which the product will meet all published specifications.
P	Part in contact with fluid	A part that comes into physical contact with the fluid.
	Pressure characteristics	The amount of variation in the analogue output or display value when the supply pressure is changed.
	Proof pressure	The pressure beyond which the product will be damaged.
R	Rated flow range	The flow range within which the product will meet all published specifications.
	Repeatability	Reproducibility of the display or analogue output value, when the flow is repeatedly changing.
	Response time (switch output)	The time from when the flow is applied as a step input (when the flow rate changes from 0% to 100% instantaneously) until the analogue output (voltage or current) reaches 90% of the actual flow rate.
	Response time (analogue output)	The time from when the flow is applied as a step input (when the flow rate changes from 0% to 100% instantaneously) until the switch output turns ON (OFF) at 90% of the rated flow rate.
	Ripple	Indicates pulsation.
S	Set flow range	The range of ON/OFF threshold values that can be set for products with a switch output.
	Switch output	An output type that has only 2 conditions, ON or OFF. In the ON condition an indicator LED will turn on, and any connected load will be powered. In the OFF condition, there will be no indicator LED and no power is supplied to the load.
T	Temperature characteristic	The amount of variation in the analogue output or display value when the ambient temperature is changed.
U	Unit selection function	Function to change the unit in which the value of flow is displayed. Only a product with this function can change the unit. A product with unit selection function cannot be purchased if it is used within Japan. Flow is indicated only by SI units in Japan.
W	Window comparator mode	An operating mode in which the switch output is turned on or off depending on whether the flow is within the range of 2 set values.

## Mounting and Installation

### Mounting

- Never mount the product in a place where it will be used as a mechanical support.
- Mount the product so that the fluid flows in the direction indicated by the arrow on the side of the body.

### ■ Installation

#### Bracket mounting

- Mount the bracket to the product using the mounting screws (4 pcs.).
- Fasten the bracket mounting screws to a torque of 0.5 to 0.7 Nm.
- Self tapping screws are used, and should not be re-used several times.

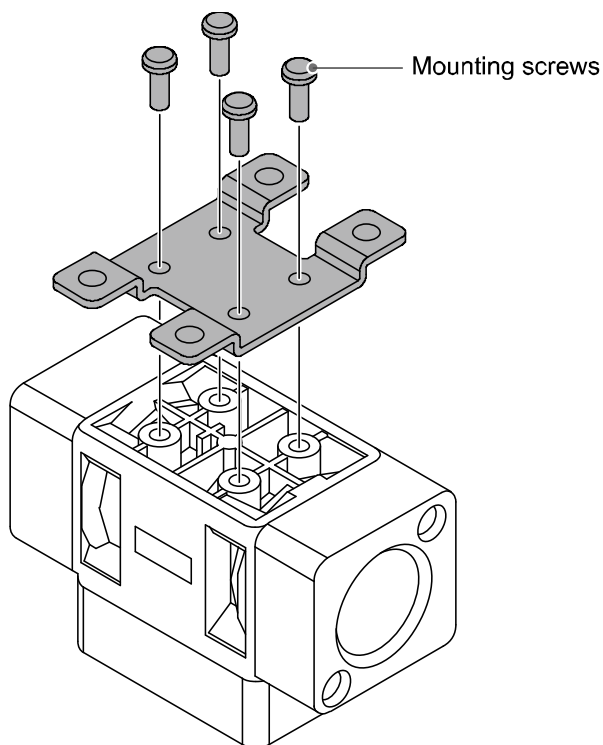

- Mount the product with bracket using M4 screws (4 pcs.) or equivalent.
- Screws are prepared by customer.
- Refer to the dimension drawing (page 67) for the bracket thickness and mounting hole dimensions.

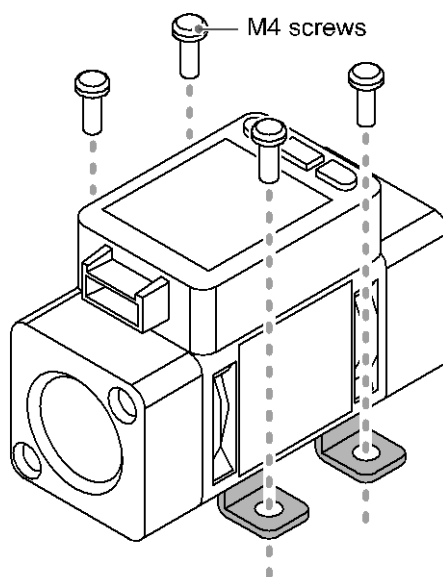

### Direct mounting

- For direct mounting use self tapping screws (nominal size: 3.0 x 4 pcs.).
- Screws are prepared by customer.
- Refer to the dimension drawing (page 67) for the diameter and depth of the mounting screw holes.
- Tightening torque is 0.5 to 0.7 Nm.
- Self tapping screws are used, and should not be re-used several times.

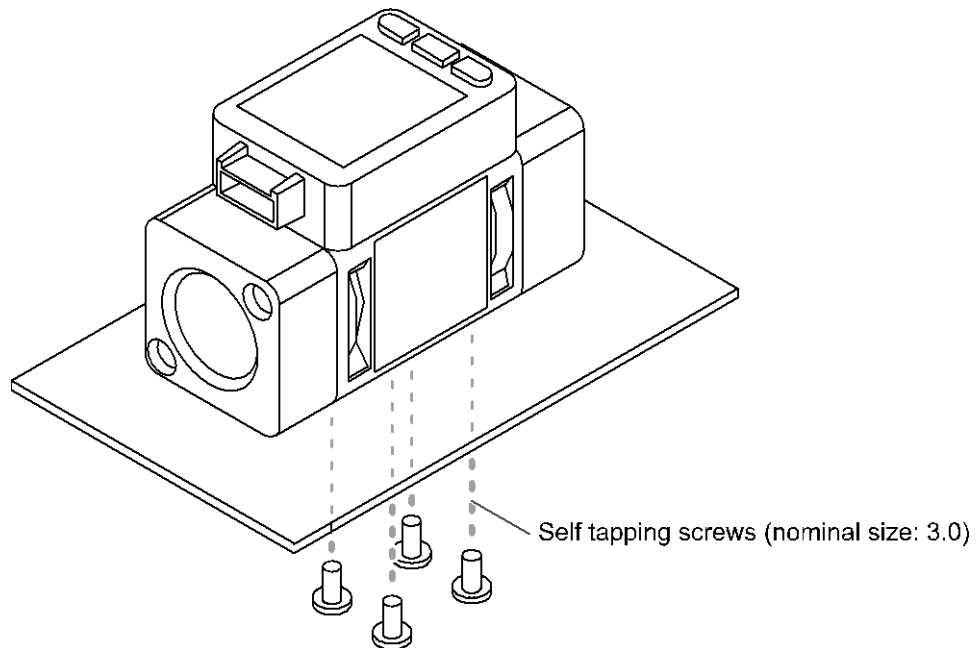



## ■ Piping

- Never mount the product upside down.
- The straight piping length shall be 8 cm or longer.  
Otherwise, if a straight section of piping is not installed, the accuracy varies by approximately  $\pm 2\%$ F.S. Refer to the straight inlet piping length and accuracy graph (page 66).
- Avoid sudden changes in the piping size on the IN side of the product.
- Do not release the OUT side piping port of the product directly to the atmosphere without the piping connected.

If the product is used with the piping port released to atmosphere, the accuracy may vary.

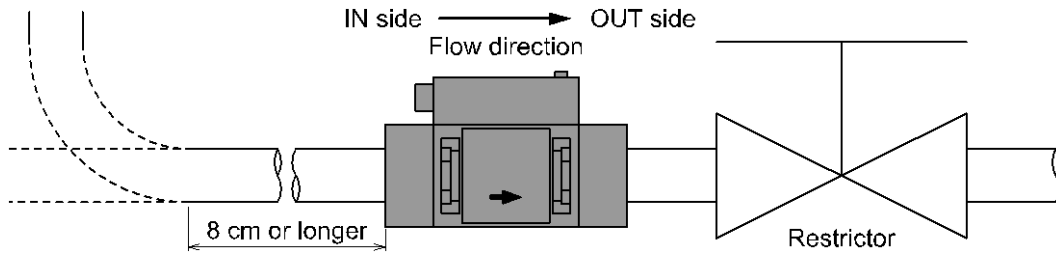

### Piping for the metal attachment

- Tighten to the specified torque. Refer to the table below for the required torque values.
- Use a suitable spanner for the appropriate torque. Do not use a spanner 40 cm or longer.
- If the tightening torque is exceeded, the product can be broken.  
If the tightening torque is insufficient, the fitting may become loose.
- Avoid any sealing tape getting inside the flow path.
- Ensure there is no leakage after piping.
- When mounting the fitting, a spanner should be used on the metal part (attachment) of the fitting only. Holding other parts of the product with a spanner may damage the product. Specifically, make sure that the spanner does not damage the connector.

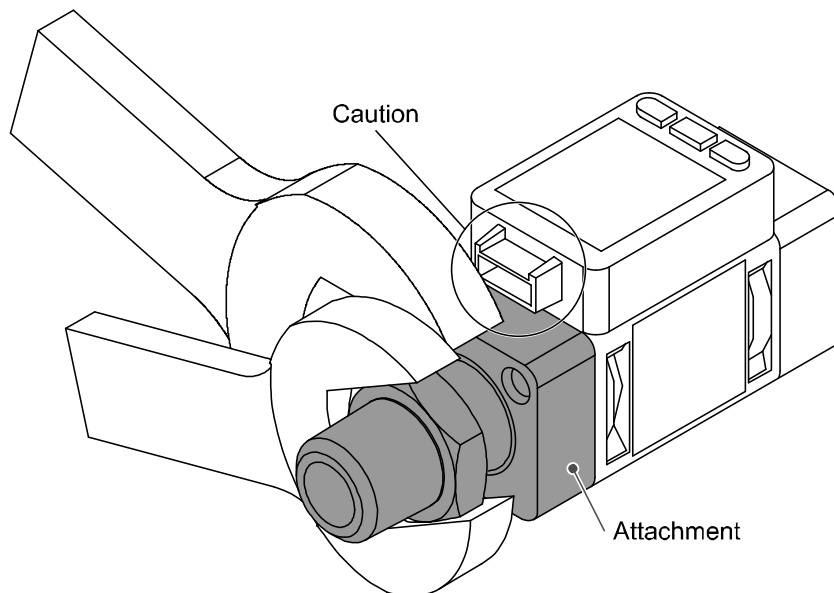

Nominal thread size	Required torque
Rc1/2, NPT1/2, Rc3/4, NPT3/4	28 to 30 Nm

Piping port size	Width across flats of attachment
1/2	30 mm
3/4	35 mm

### Piping for the One-touch fitting

- For the one-touch fitting, use tubing with a tube inside diameter of 9 mm or more.  
Accuracy can vary approximately  $\pm 2\%$ F.S. when such tubing is not used.

## ■ Wiring

### Connection

- Connections should only be made with the power supply turned off.
- Use a separate route for the product wiring and any power or high voltage wiring. Otherwise, malfunction may result due to noise.
- Ensure that the FG terminal is connected to ground when using a commercially available switch-mode power supply. When a switch-mode power supply is connected to the product, switching noise will be superimposed and the product specification can no longer be met. This can be prevented by inserting a noise filter, such as a line noise filter and ferrite core, between the switch-mode power supply and the product or by using a series power supply instead of a switch-mode power supply.

### Connecting/Disconnecting

- When mounting the connector, insert it straight into the socket, holding the lever and connector body, and push the connector until the lever hooks into the housing, and locks.
- When removing the connector, press down the lever to release the hook from the housing and pull the connector straight out.

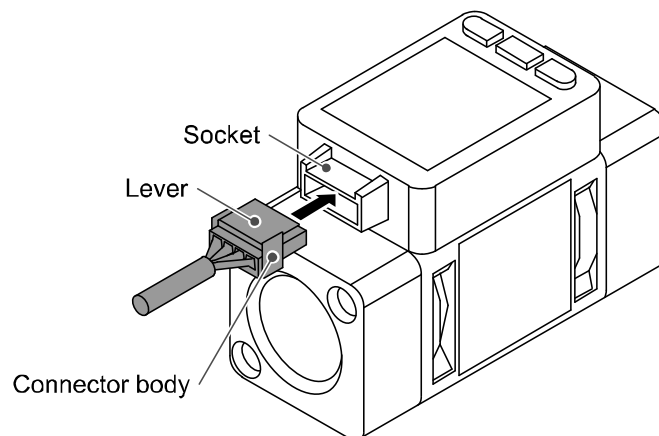

### Connector pin numbers (lead wire)

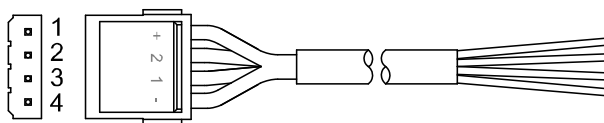

Connector pin numbers	Wire colour	Description
1	Brown	DC(+)
2	White	OUT2/Analogue output/External input
3	Black	OUT1
4	Blue	DC(-)

## Internal circuit and wiring examples

NPN (2 output) type

PFMB7□□□-□□-**A**□-□□□

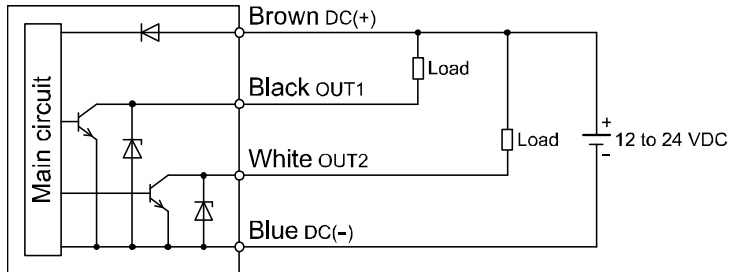

Maximum applied voltage: 28 V  
 Maximum load current: 80 mA  
 Internal voltage drop: 1 V or less

NPN (1 output) + Analogue (1 to 5 V) output type

PFMB7□□□-□□-**C**□-□□□

NPN (1 output) + Analogue (4 to 20 mA) output type

PFMB7□□□-□□-**D**□-□□□

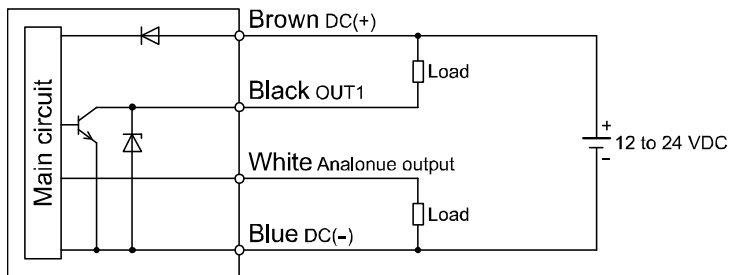

Maximum applied voltage: 28 V  
 Maximum load current: 80 mA  
 Internal voltage drop: 1 V or less  
 C: Analogue output: 1 to 5 V  
 Output impedance: 1 k $\Omega$   
 D: Analogue output: 4 to 20 mA  
 Maximum load impedance: 600  $\Omega$

NPN (1 output) + External input type

PFMB7□□□-□□-**G**□-□□□

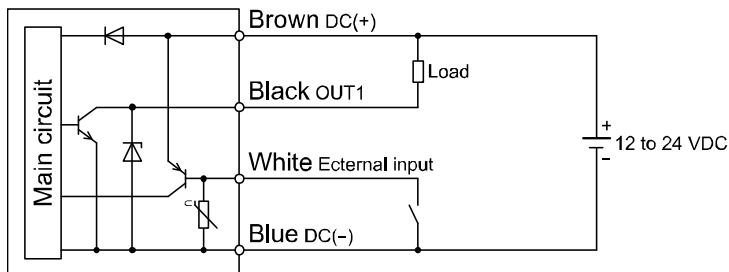

Maximum applied voltage: 28 V  
 Maximum load current: 80 mA  
 Internal voltage drop: 1 V or less  
 External input: Input voltage 0.4 V or less (reed or solid state input) for 30 msec. or longer

PNP (2 output) type

PFMB7□□□-□□-**B**□-□□□

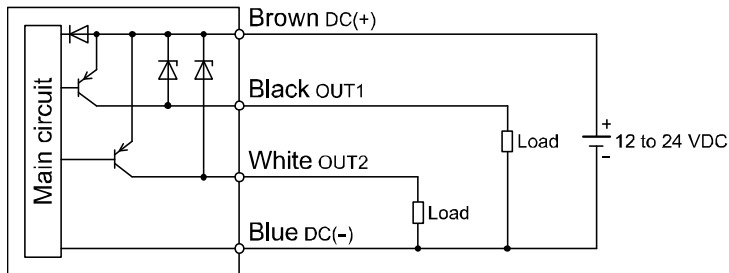

Maximum load current: 80 mA  
Internal voltage drop: 1.5 V or less

PNP (1 output) + Analogue (1 to 5 V) output type

PFMB7□□□-□□-**E**□-□□□

PNP (1 output) + Analogue (4 to 20 mA) output type

PFMB7□□□-□□-**F**□-□□□

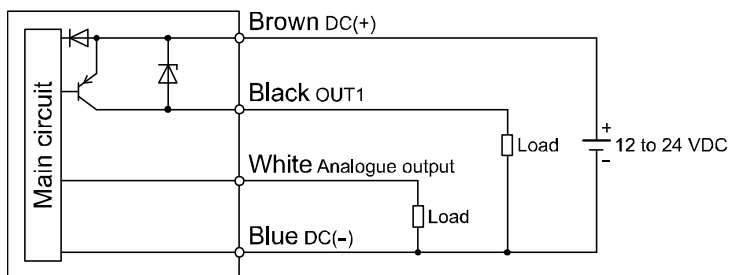

Maximum load current: 80 mA  
Internal voltage drop: 1.5 V or less  
E: Analogue output: 1 to 5 V  
Output impedance: 1 kΩ  
F: Analogue output: 4 to 20 mA  
Maximum load impedance: 600 Ω

PNP (1output) + External input type

PFMB7□□□-□□-**H**□-□□□

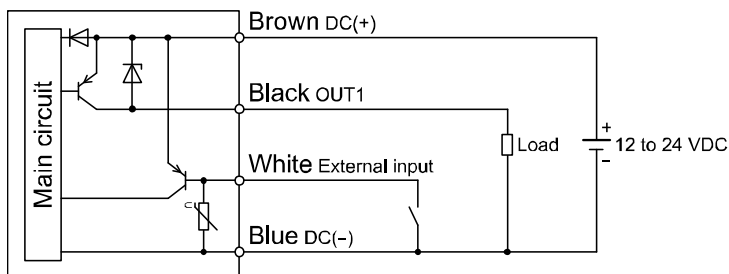

Maximum load current: 80 mA  
Internal voltage drop: 1.5 V or less  
External input: Input voltage 0.4 V or less (reed or solid state input) for 30 msec. or longer

## Example of wiring for accumulated pulse output

NPN (2 output) type

PFMB7□□□-□□-**A**□-□□□

NPN (1 output) + Analogue output type

PFMB7□□□-□□-**C**□-□□□

PFMB7□□□-□□-**D**□-□□□

NPN (1 output) + External input type

PFMB7□□□-□□-**G**□-□□□

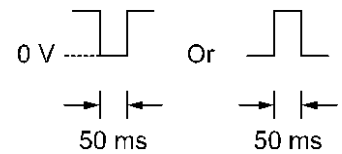
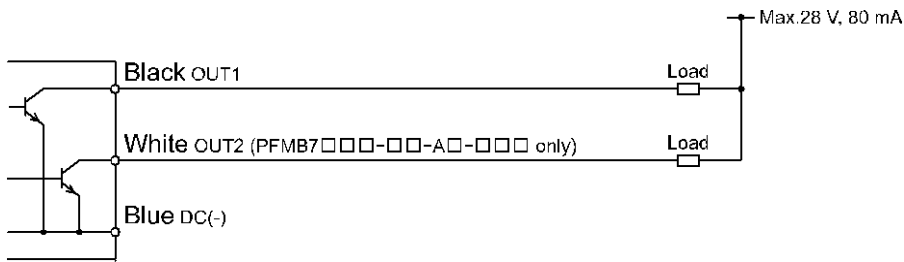

PNP (2 output) type

PFMB7□□□-□□-**B**□-□□□

PNP (1 output) + Analogue output type

PFMB7□□□-□□-**E**□-□□□

PFMB7□□□-□□-**F**□-□□□

PNP (1 output) + External input type

PFMB7□□□-□□-**H**□-□□□

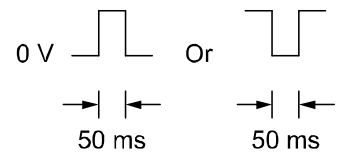
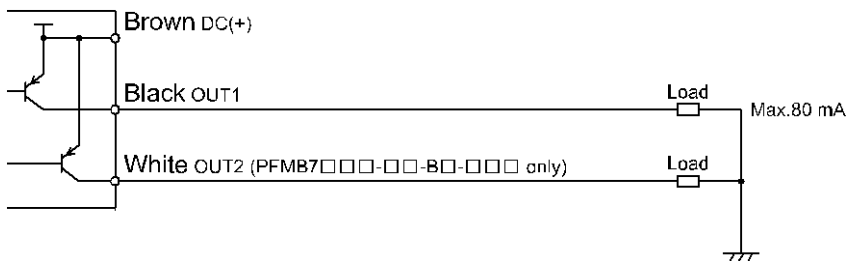

## Outline of Settings [Measurement mode]

Power is supplied



The output will not operate for 3 seconds after supplying power.  
The identification code of the product is displayed.



### [Measurement mode]

Measurement mode is the condition where the flow is detected and displayed, and the switch function is operating.  
This is the basic mode; other modes should be selected for set-point changes and other function settings.

↑↓ Press the **S** button once.

↑↓ Press the **S** button for 2 seconds or longer.



**Flow Setting**  
[3 step setting mode]  
(Refer to page 22.)

**Function Setting**  
[Function selection mode]  
(Refer to page 24.)

**Other Functions**  
(Refer to page 54.)

- \*: The outputs will continue to operate during setting.
- \*: If a button operation is not performed for 30 seconds during the setting, the display will flash. (This is to prevent the setting from remaining incomplete if, for instance, an operator were to leave during setting)
- \*: 3 step setting mode and Function selection mode are reflected on each other.

## Flow Setting (set value only) of OUT1 - OUT2 [3 step setting mode]

### 3 step setting mode

In this mode, only the set values can be input, in just 3 steps.

Use this mode if the product is to be used straight away, after changing only the set values.

#### ■ Default settings

When the flow exceeds the set value [P\_1], the switch will be turned ON.

When the flow falls below the set value by the amount of hysteresis [H\_1] or more, the switch will turn OFF.

If the operation shown in the diagram below is acceptable, then keep these settings.

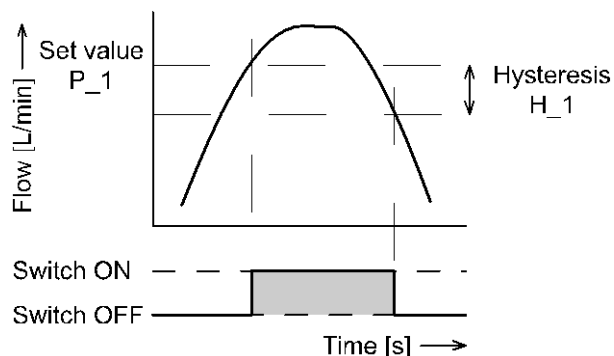

#### ● PFMB7501

Item	Default settings
[P_1] Set value of OUT1	250 L/min
[H_1] Hysteresis of OUT1	25 L/min
[P_2] Set value of OUT2 *	250 L/min
[H_2] Hysteresis of OUT2 *	25 L/min

#### ● PFMB7102

Item	Default settings
[P_1] Set value of OUT1	500 L/min
[H_1] Hysteresis of OUT1	50 L/min
[P_2] Set value of OUT2 *	500 L/min
[H_2] Hysteresis of OUT2 *	50 L/min

#### ● PFMB7202

Item	Default settings
[P_1] Set value of OUT1	1000 L/min
[H_1] Hysteresis of OUT1	100 L/min
[P_2] Set value of OUT2 *	1000 L/min
[H_2] Hysteresis of OUT2 *	100 L/min

\*: Only available for models with switch outputs for both OUT1 and OUT2.

\*: For input of hysteresis, perform the settings referring to [F 1] Setting of OUT1 (page 28 to) and [F 2] Setting of OUT2 (page 36 to).

<Operation>

1. Press the **S** button once in measurement mode.  
[P\_1] or [n\_1] and [the current set value] are displayed in turn.

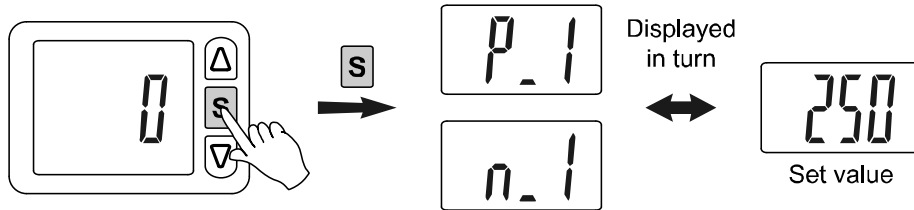

2. Press the **Δ** or **▽** button to change the set value.  
The **Δ** button is to increase and the **▽** button is to decrease the set value.

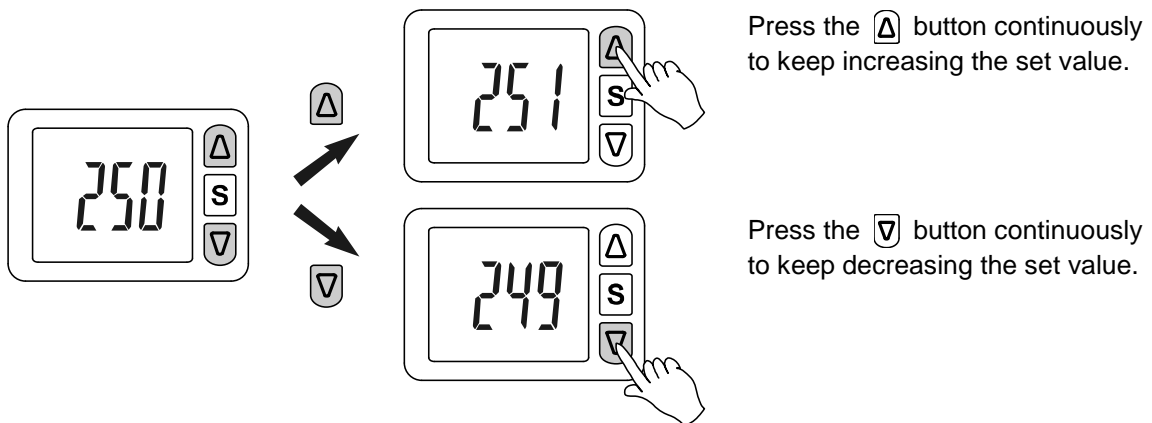

3. Press the **S** button to complete the setting.  
Return to measurement mode.

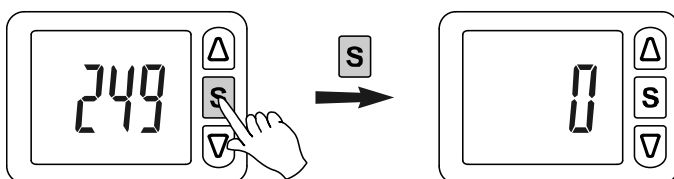

- \*: The above example is for the 500 L/min type.
- \*: For models with switch outputs for both OUT1 and OUT2, [P\_2] or [n\_2] will be displayed too. Set as above.
- \*: For input of hysteresis, perform the settings referring to [F 1] Setting of OUT1 (page 28 to) and [F 2] Setting of OUT2 (page 36 to).
- \*: When a mode other than hysteresis mode is selected, "Set value" of page 29 is displayed.
- \*: Note that the set value and hysteresis are limited by each other.
- \*: For more detailed settings, set each function in function selection mode (page 24).



## Function Setting [Function selection mode]

### Function selection mode

In this mode, each function setting can be changed separately.

**In measurement mode, press the **S** button for 2 seconds or longer, to display [F 0].**

Press the **Δ** or **∇** button to select the function to be changed.

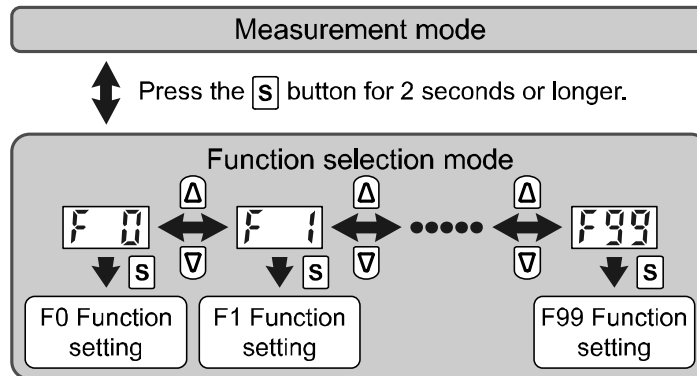

Press the **S** button for 2 seconds or longer in function selection mode to return to measurement mode.

## ■ Default settings

	Item	Default settings	Page	
[F 0] ⇔ [rEF]	[rEF] Reference condition	[Anr] Standard condition	page 26	
	[Uni] Unit selection function *1	[ L] L/min		
[F 1] ⇔ [oU1]	[oU1] Output mode of OUT1	[HYS] Hysteresis mode	page 28	
	[1ot] Switch operation of OUT1	[1_P] Normal output		
	[P_1] Set value of OUT1	[ 250] 250 L/min (PFMB7501)		
		[ 500] 500 L/min (PFMB7102)		
		[1000] 1000 L/min (PFMB7202)		
	[H_1] Hysteresis of OUT1	[ 25] 25 L/min (PFMB7501)		
		[ 50] 50 L/min (PFMB7102)		
[100] 100 L/min (PFMB7202)				
[CoL] Display colour of OUT1	[SoG] Green when ON, Red when OFF			
[F 2] ⇔ [oU2]	[oU2] Output mode of OUT2 *2	[HYS] Hysteresis mode	page 36	
	[2ot] Switch operation of OUT2 *2	[2_P] Normal output		
	[P_2] Set value of OUT2 *2	[ 250] 250 L/min (PFMB7501)		
		[ 500] 500 L/min (PFMB7102)		
		[1000] 1000 L/min (PFMB7202)		
	[H_2] Hysteresis of OUT2 *2	[ 25] 25 L/min (PFMB7501)		
		[ 50] 50 L/min (PFMB7102)		
[100] 100 L/min (PFMB7202)				
[F 3] ⇔ [rES]	[rES] Response time	[1. 00] 1 second	page 41	
[F10] ⇔ [FLo]	[FLo] Display mode	[inS] Display instantaneous flow	page 42	
[F13] ⇔ [rEv]	[rEv] Reversed display mode	[oFF] Not reversed	page 43	
[F20] ⇔ [inP]	[inP] External input *3	[rAC] Accumulated flow external reset	page 44	
[F22] ⇔ [FrE]	[FrE] Setting of analogue output *4	[oFF] Variable range OFF	page 45	
[F30] ⇔ [SAv]	[SAv] Accumulated value hold	[oFF] Not held	page 46	
[F31] ⇔ [PoS]	[PoS] Orientation	[Hor] Horizontal mounting	page 47	
	[PrS] Supply pressure	[Mi d] 0.4 MPa minimum, 0.6 MPa maximum		
[F80] ⇔ [dSP]	[dSP] Display OFF mode	[ on] Display ON	page 48	
[F81] ⇔ [Pin]	[Pin] Security code	[oFF] Not used	page 49	
[F90] ⇔ [ALL]	[ALL] Setting of all functions	[oFF] Not used	page 50	
[F98] ⇔ [tES]	[tES] Output check	[oFF] Normal output	page 52	
[F99] ⇔ [ini]	[ini] Reset to the default settings	[oFF] Reset OFF	page 53	

\*1: This setting is only available for models with the unit selection function.

\*2: This setting is only available for models with switch output for both OUT1 and OUT2.

\*3: This setting is only available for models with the external input.

\*4: This setting is only available for models with the analogue output.

■ [F 0] Reference condition/Unit selection function

**Reference condition**

Standard condition or normal condition can be selected.

**Unit selection function**

The selectable display units are L/min or CFM (ft<sup>3</sup>/min). \*

This setting is only available for models with the unit selection function.

\*: This function is not displayed for models without unit selection function.

<Operation>

Press the or button in function selection mode to display [F 0].

[F 0] and [rEF] are displayed in turn.

Displayed in turn

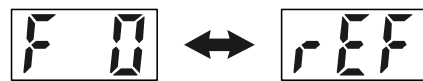

↓ Press the button.

**Reference condition**

[rEF] and [the current set value] are displayed in turn.

Displayed in turn

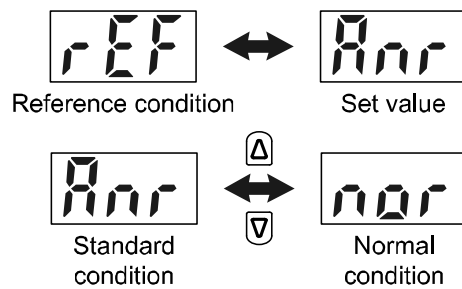

Press the or button to select.

Press the button to set.  
(Fixed to SI units)

Press the button to set.  
(with for unit selection function)

**Unit selection function**

[Uni] and [the current set value] are displayed in turn.

Displayed in turn

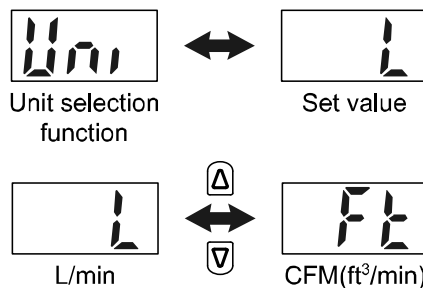

Press the or button to select.

↓ Press the button to set.

[F 0] Setting of reference condition · Unit selection function completed.  
Return to function selection mode.

Flow specification when [ Ft ] is selected during the unit selection function.

Model		PFMB7501	PFMB7102	PFMB7202	
Flow	Rated flow range		0.2 to 17.7 cfm	0.4 to 35.3 cfm	0.8 to 70.6 cfm
	Set flow rate range	Instantaneous flow	0.4 to 37.1 cfm	0.4 to 37.1 cfm	0.8 to 74.2 cfm
		Accumulated flow	0 to 999,999,999 ft <sup>3</sup>		
	Minimum setting unit	Instantaneous flow	0.1 cfm		
		Accumulated flow	1 ft <sup>3</sup>		
Accumulated volume per pulse		0.1 ft <sup>3</sup> /pulse		1 ft <sup>3</sup> /pulse	
Display	Displayable range	Instantaneous flow	-0.9 to 18.6 cfm (Displays [ 0 ] when the value is between -0.2 and 0.2.)	-1.8 to 37.1 cfm (Displays [ 0 ] when the value is between -0.4 and 0.4.)	-3.6 to 74.2 cfm (Displays [ 0 ] when the value is between -0.8 and 0.8.)
		Accumulated flow	0 to 999,999,999 ft <sup>3</sup>		
	Minimum display unit	Instantaneous flow	0.1 cfm		
		Accumulated flow	1 ft <sup>3</sup>		

\*: Flow rate in the specification is the value at standard condition.

## ■[F 1] Setting of OUT1

Set the output mode of OUT1.

### ● Switch output operation list

Select the operation required from the table below. Characters in ( ) are for OUT2.

	Normal output	Reversed output
Hysteresis mode		
Window comparator mode		
Accumulated output mode	<p>Display: Count up</p> <ul style="list-style-type: none"> <li>Count up from "0".</li> <li>Turn ON when the set value is reached.</li> <li>Return to "0" by reset.</li> </ul>	<p>Display: Count up</p> <ul style="list-style-type: none"> <li>Count up from "0".</li> <li>Turn OFF when the set value is reached.</li> <li>Return to "0" by reset.</li> </ul>
	<p>Display: Count down</p> <ul style="list-style-type: none"> <li>Count down from set value.</li> <li>Turn ON when the "0" is reached.</li> <li>Return to set value by reset.</li> </ul>	<p>Display: Count down</p> <ul style="list-style-type: none"> <li>Count down from set value.</li> <li>Turn OFF when the "0" is reached.</li> <li>Return to set value by reset.</li> </ul>
Accumulated pulse output mode		

\*: The operation may become unstable if hysteresis mode or window comparator mode are used during fluctuating flow conditions. In this case, maintain an interval between the set values and start using after confirming stable operation.

● Setting flowchart

Refer to the list of Switch output operation list for the setting procedure. Characters in ( ) are for OUT2. Mark the procedure path with a pen or marker.

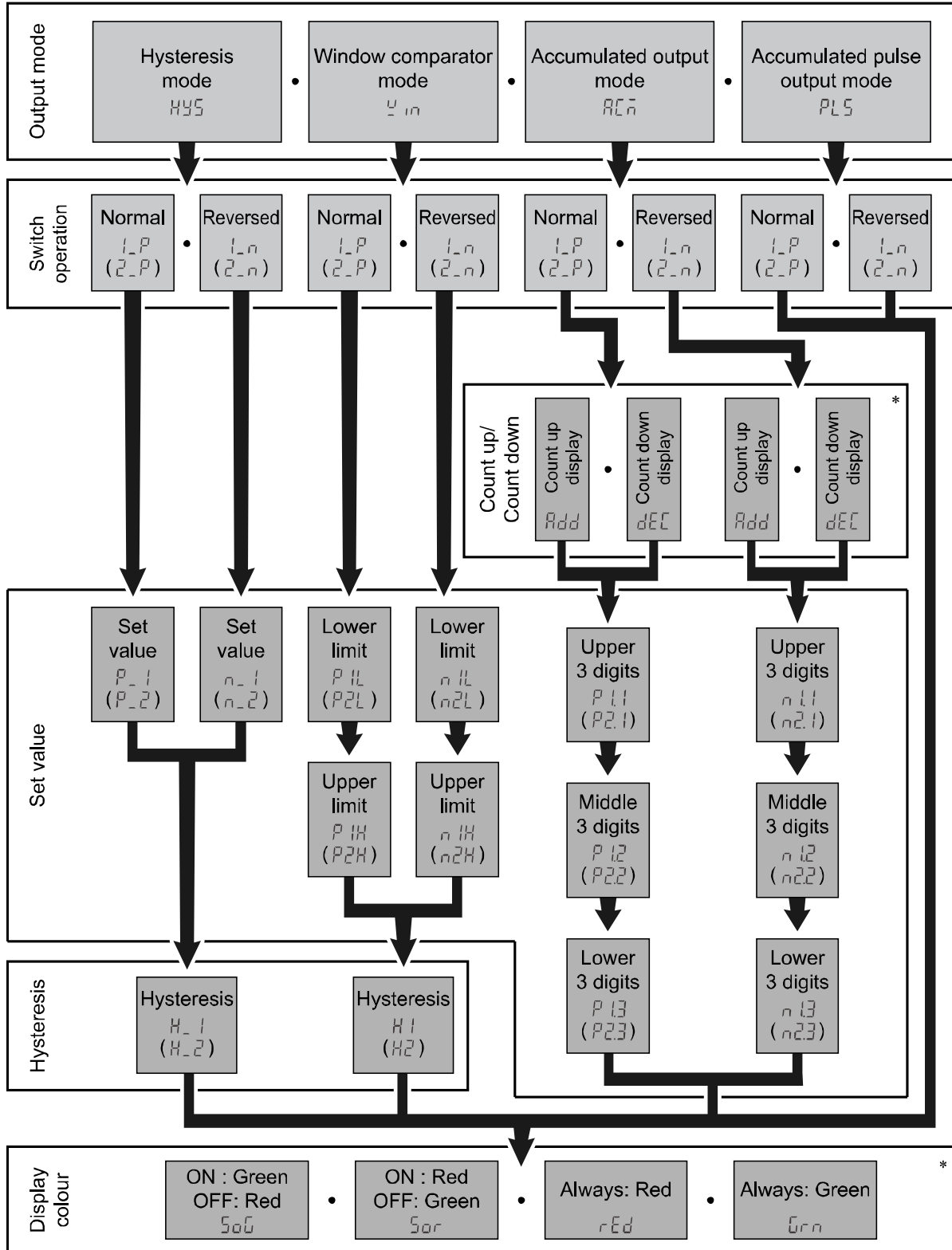

\*: OUT2 cannot be set.

Enter the items that you selected, following the procedure below.

Follow the Setting flowchart.

<Operation>: Setting of OUT1

Press the  $\Delta$  or  $\nabla$  button in function selection mode to display [F 1].

[F 1] and [oU1] are displayed in turn.

Displayed in turn

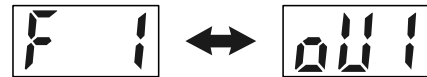

↓ Press the **S** button.

### Output mode

[oU1] and [the current set value] are displayed in turn.

Press the  $\Delta$  or  $\nabla$  button to select.

Displayed in turn

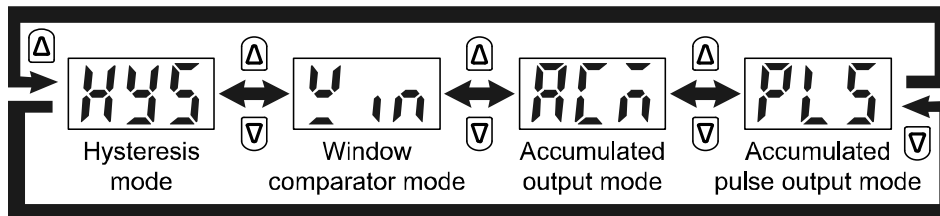
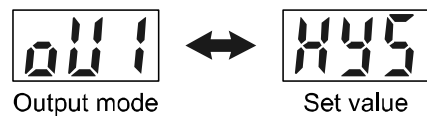

↓ Press the **S** button to set.

### Switch operation

[1ot] and [the current set value] are displayed in turn.

Press the  $\Delta$  or  $\nabla$  button to select.

\*: By switching to reversed output, the display colour will change in relation to the setting.

Displayed in turn

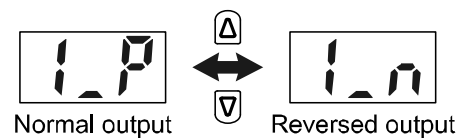
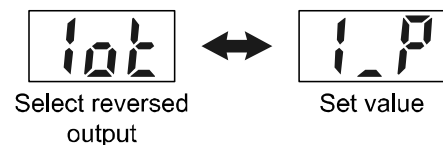



↓ Press the **S** button to set.

When hysteresis mode is selected: Refer to page 31.  
 When window comparator mode is selected: Refer to page 32.  
 When accumulated output mode is selected: Refer to page 33.  
 When accumulated pulse output mode is selected: Refer to page 35.

a. When hysteresis mode is selected

**Set value**

[P\_1] or [n\_1] and [the current set value] are displayed in turn.

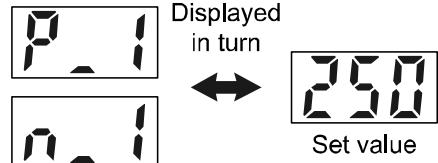

Press the  or  button to change the value.





↓ Press the  button to set.

**Hysteresis**

[H\_1] and [the current set value] are displayed in turn.

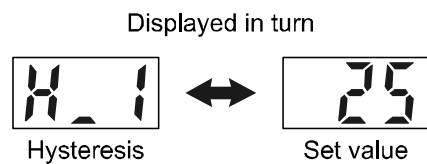
Press the  or  button to change the value.



↓ Press the  button to set.

**Display colour**

The display colour can be set to change depending upon the status of OUT1.

[CoL] and [the current set value] are displayed in turn.

Press the  or  button to select.

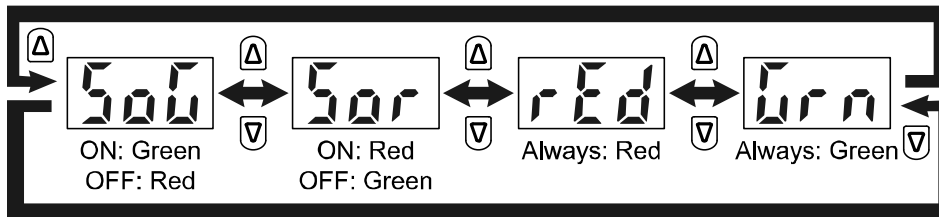
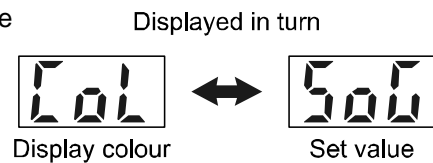

↓ Press the  button to set.

[F 1] Setting of OUT1 completed.  
Return to function selection mode.

\*: The above example is for the 500 L/min type.

\*: The set value and hysteresis settings limit each other.





b. When window comparator mode is selected

**Set value (Lower limit value)**

[P1L] or [n1L] and [the current set value] are displayed in turn.

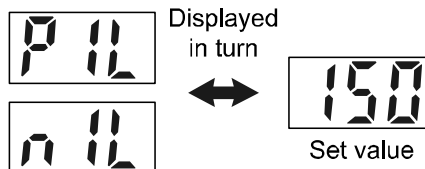
Press the  or  button to change the value.





↓ Press the  button to set.

**Set value (Upper limit value)**

[P1H] or [n1H] and [the current set value] are displayed in turn.

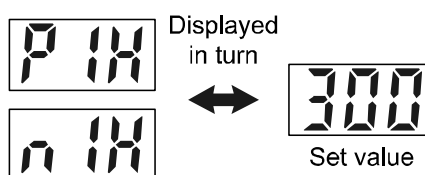
Press the  or  button to change the value.





↓ Press the  button to set.

**Hysteresis**

[H1] and [the current set value] are displayed in turn.

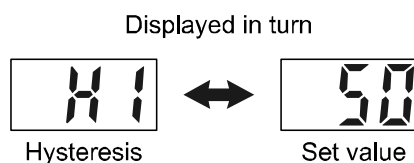
Press the  or  button to change the value.



↓ Press the  button to set.

**Display colour**

The display colour can be set to change depending upon the status of OUT1.

[CoL] and [the current set value] are displayed in turn.

Press the  or  button to select.

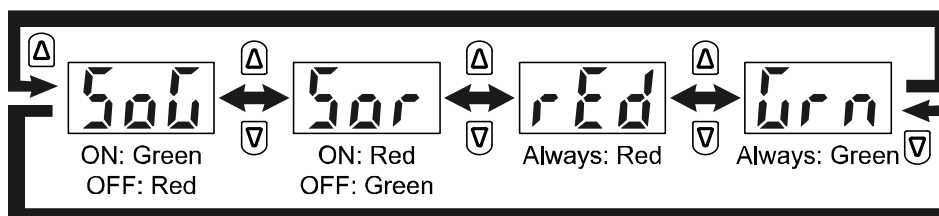
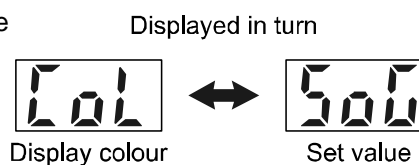

↓ Press the  button to set.

[F 1] Setting of OUT1 completed.  
Return to function selection mode.

\*: The above example is for the 500 L/min type.  
\*: The set value and hysteresis settings limit each other.

c. When accumulated output mode is selected

**Count up display (addition) or count down (decrement)**

[AC1] and [the current set value] are displayed in turn.

Press the  or  button to select.

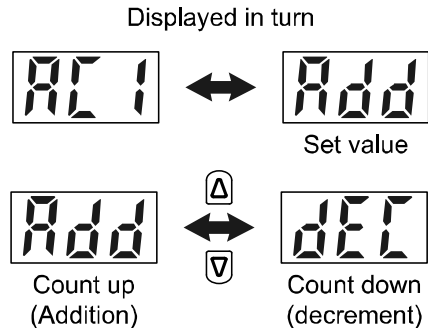

↓ Press the  button to set.

The accumulated output can be set between 0 and 999999999 L.  
 The set value is input starting from the upper 3 digits.  
 The position of the dots indicates which digits are displayed.

**Set value (upper 3 digits)**

[P1.1] or [n1.1] and [the current set value] are displayed in turn.

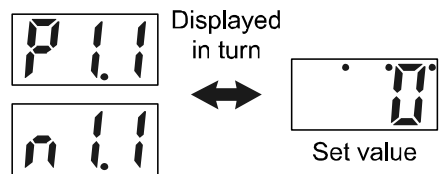

Press the  or  button to change the value.



↓ Press the  button to set.

**Set value (middle 3 digits)**

[P1.2] or [n1.2] and [the current set value] are displayed in turn.

Press the  or  button to change the value.

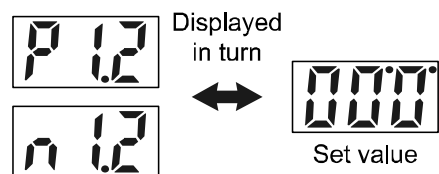

↓ Press the  button to set. (continue)



### Set value (lower 3 digits)

[P1.3] or [n1.3] and [the current set value] are displayed in turn.

Press the or button to change the value.

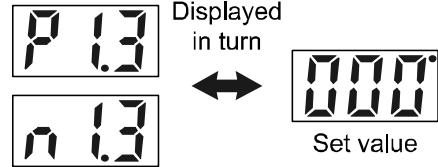

Press the button to set.

### Display colour

The display colour can be set to change depending upon the status of OUT1.

[CoL] and [the current set value] are displayed in turn.

Press the or button to select.

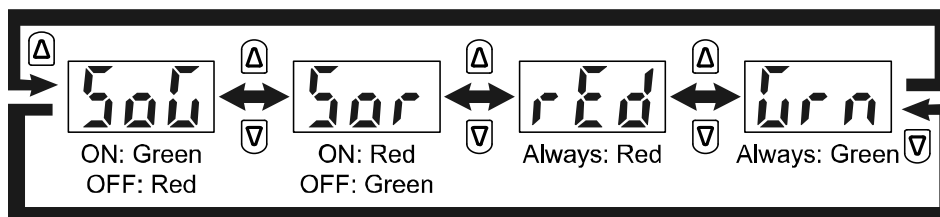
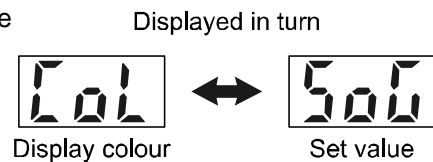

Press the button to set.

[F 1] Setting of OUT1 completed.  
Return to function selection mode.

d. When accumulated pulse output mode is selected

**Display colour**

The display colour can be set to change depending upon the status of OUT1.

[CoL] and [the current set value] are displayed in turn.

Press the  or  button to select.

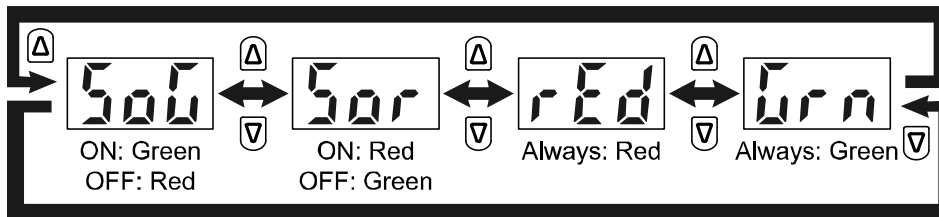
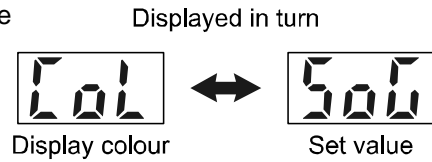

↓ Press the  button to set.

[F 1] Setting of OUT1 completed.  
Return to function selection mode.

- \*: When the accumulated pulse output mode is selected, the output operation indicator LED will turn off.
- \*: When the flow rate is less than the rated flow range, the accumulated pulse output will not operate.
- \*: When the flow exceeds the maximum display range, the accumulated pulse output will be equivalent to the maximum display value.



## ■ [F 2] Setting of OUT2

Set the output mode of OUT2.

Refer to the list of switch output modes (page 28) and the flow setting chart (page 29).

\*: When using a model without OUT2 (switch output), this setting is not available and [---] will be displayed.

<Operation>: Setting of OUT2

Press the  or  button in function selection mode to display [F 2].

[F 2] and [oU2] are displayed in turn.

\*: If OUT2 is not available, [---] will be displayed.

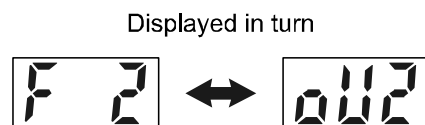

↓ Press the  button.

### Output mode

[oU2] and [the current set value] are displayed in turn.

Press the  or  button to select.

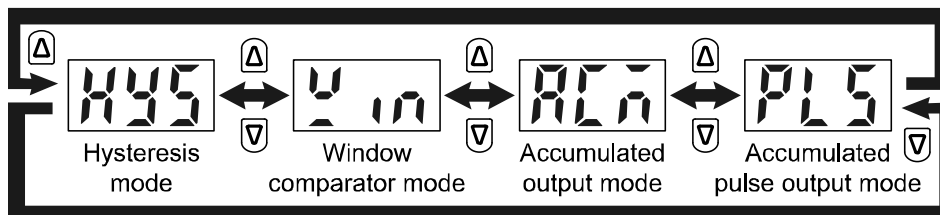
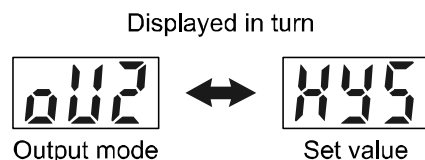

↓ Press the  button to set.

### Switch mode

[2ot] and [the current set value] are displayed in turn.

Press the  or  button to select.

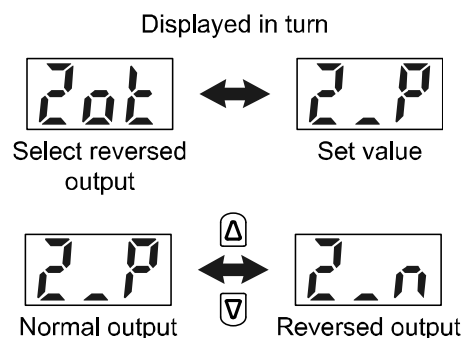

↓ Press the  button to set.

When hysteresis mode is selected: Refer to page 37.

When window comparator mode is selected: Refer to page 38.



When accumulated output mode is selected: Refer to page 39.

When accumulated pulse output mode is selected: Refer to page 40.

a. When hysteresis mode is selected

**Set value**

[P\_2] or [n\_2] and [the current set value] are displayed in turn.

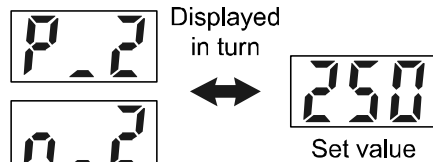

Press the  or  button to change the value.





↓ Press the  button to set.

**Hysteresis**

[H\_2] and [the current set value] are displayed in turn.

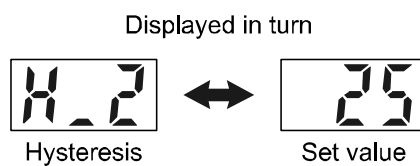
Press the  or  button to change the value.



↓ Press the  button to set.

[F 2] Setting of OUT2 completed.  
Return to function selection mode.



\*: The above example is for the 500 L/min type.

\*: The set value and hysteresis settings limit each other.

b. When window comparator mode is selected

**Set value (Lower limit value)**

[P2L] or [n2L] and [the current set value] are displayed in turn.

Press the  or  button to change the value.

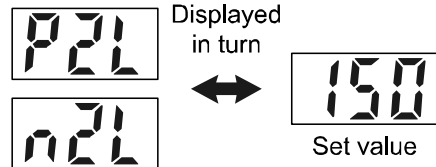



↓ Press the  button to set.

**Set value (Upper limit value)**

[P2H] or [n2H] and [the current set value] are displayed in turn.

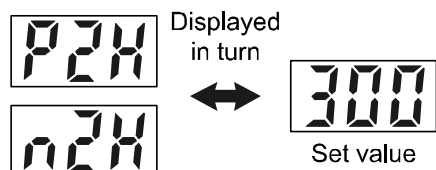

Press the  or  button to change the value.





↓ Press the  button to set.

**Hysteresis**

[ H2] and [the current set value] are displayed in turn.

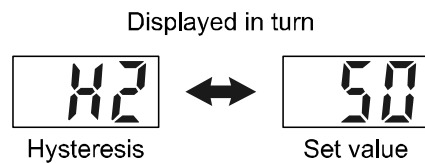
Press the  or  button to change the value.



↓ Press the  button to set.

[F 2] Setting of OUT2 completed.  
Return to function selection mode.

\*: The above example is for the 500 L/min type.

\*: The set value and hysteresis settings limit each other.

\*: The display colour is defined by OUT1 and cannot be changed with any OUT2 settings.

c. When accumulated output mode is selected



The accumulated output can be set between 0 and 999999999 L.

The set value is input starting from the upper 3 digits.

The position of the dots indicates which digits are displayed

**Set value (upper 3 digits)**

[P2.1] or [n2.1] and [the current set value] are displayed in turn.

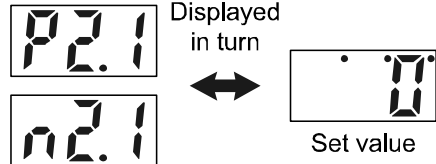

Press the  or  button to change the value.





↓ Press the  button to set.

**Set value (middle 3 digits)**

[P2.2] or [n2.2] and [the current set value] are displayed in turn.

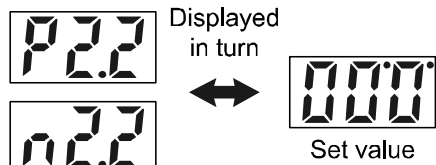
Press the  or  button to change the value.



↓ Press the  button to set.

**Set value (lower 3 digits)**

[P2.3] or [n2.3] and [the current set value] are displayed in turn.

Press the  or  button to change the value.

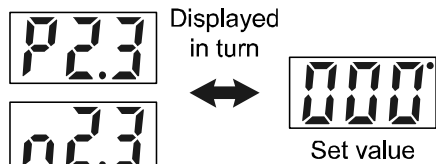

↓ Press the  button to set.

[F 2] Setting of OUT2 completed.  
Return to function selection mode.

\*: Count up or count down display are defined by OUT1 and cannot be changed with any OUT2 settings.

\*: The display colour is defined by OUT1 and cannot be changed with any OUT2 settings.



d. When accumulated pulse output mode is selected

↓ Press the **S** button to set.

[F 2] Setting of OUT2 completed.  
Return to function selection mode.

- \*: The display colour is defined by OUT1 and cannot be changed with any OUT2 settings.
- \*: When the accumulated pulse output mode is selected, the output operation indicator LED will turn off.
- \*: When the flow rate is less than the rated flow range, the accumulated pulse output will not operate.
- \*: When the flow exceeds the maximum display range, the accumulated pulse output will be equivalent to the maximum display value.

## ■ [F 3] Response time

The response time of the switch output and analogue output can be selected.  
Output chattering can be prevented by setting the response time.

<Operation>

Press the  $\Delta$  or  $\nabla$  button in function selection mode to display [F 3].

[F 3] and [rES] are displayed in turn.

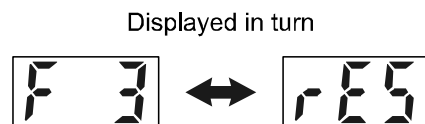

↓ Press the **S** button.

### Response time

[rES] and [the current set value] are displayed in turn.

Press the  $\Delta$  or  $\nabla$  button to select.

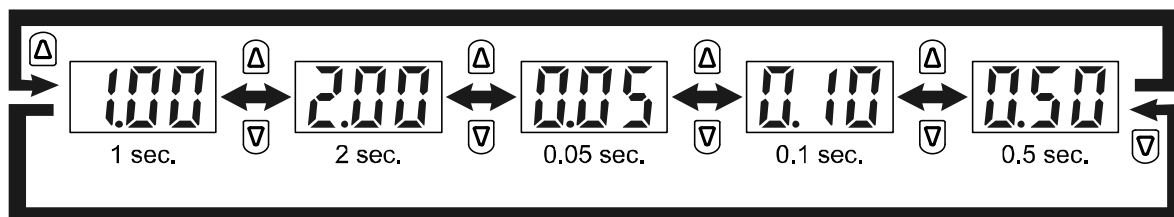
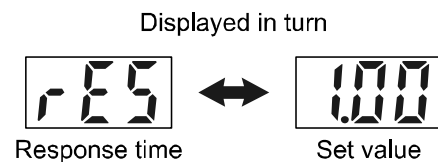

↓ Press the **S** button to set.

[F3] Setting of response time completed.  
Return to function selection mode.

## ■ [F10] Display mode

Select instantaneous flow or accumulated flow to be displayed.

<Operation>

Press the or button in function selection mode to display [F10].

[F10] and [FLo] are displayed in turn.

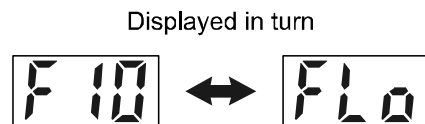

↓ Press the button.

### Display mode

[FLo] and [the current set value] are displayed in turn.

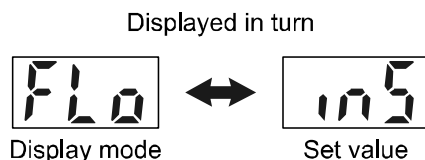

Press the or button to select.

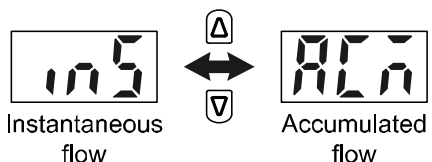

↓ Press the button to set.

[F10] Setting of display mode completed.  
Return to function selection mode.



- The accumulation flow count will start when power is supplied.
- Accumulated flow can be displayed up to 999999999 L (9999999999 ft<sup>3</sup>).  
The position of the dots indicates which digits are displayed.  
The first 3 digits of the measurement value are always displayed (It changes automatically).  
Press the and buttons to display the other digits.

Accumulated value	Upper 3 digits	Middle 3 digits	Lower 3 digits
50 L	button 	button 	Always displayed 
60,010 L	button 	Always displayed 	button 
203,481,020 L	Always displayed 	button 	button 



- The accumulated value can be reset as follows:
  - Accumulated flow reset (page 54).
  - Accumulated flow external reset (page 44).
  - Turn the power ON (this will not reset the value if accumulated value hold is selected, refer to page 46).

## ■ [F13] Reversed display mode

This function is used to rotate the display upside down. It is used to correct the display when it is upside down due to the installation of the product.

When the reversed display is used, the function of the  and  buttons is reversed.

<Operation>

Press the  or  button in function selection mode to display [F13].

[F13] and [rEv] are displayed in turn.

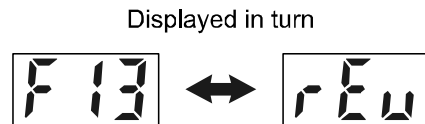

↓ Press the  button.

### Reversed display mode

[rEv] and [the current set value] are displayed in turn.

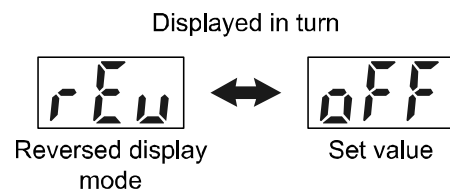

Press the  or  button to select.

\*: The display is reversed as soon as [ON] is selected.

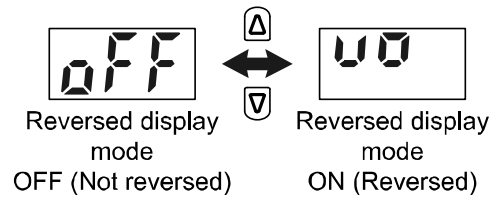

↓ Press the  button to set.

[F13] Setting of reversed display mode completed.  
Return to function selection mode.

## ■ [F20] External input

This function is available when the model includes the external input function. The accumulated value, peak value and bottom value can be reset remotely.

\*: When using a model without external input function, this setting is not available and [---] will be displayed.

● **Accumulated flow external reset:** A function to reset the accumulated flow value when an external input signal is applied.

When “Count up display”, the accumulated flow value will reset to zero, and then increase from zero. When “Count down display”, the accumulated flow value will reset to a set value, and then decrease from the set value.

\*: Each time the accumulated flow external reset is activated and when the accumulated flow value is stored, a memory device (EEPROM) is accessed. The memory device has a limit of 1 million cycles. When using the product, it should be considered that the total number of external input resets and accumulated values stored must not exceed 1 million.

● **Peak/Bottom external reset:** A function to clear the peak value or bottom value when an external input signal is applied.

● **OFF:** The external input function will not operate.

<Operation>

Press the  or  button in function selection mode to display [F20].

[F20] and [inP] are displayed in turn.

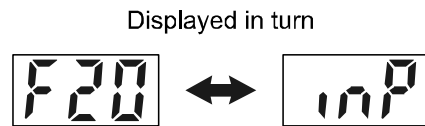



↓ Press the  button.

**External input**

[inP] and [the current set value] are displayed in turn.

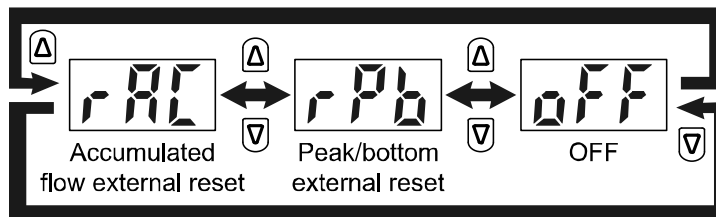
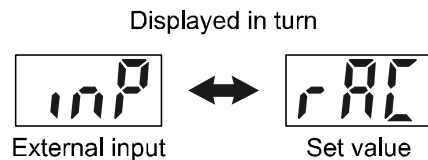
Press the  or  button to select.



↓ Press the  button to set.

[F20] Setting of external input completed.  
Return to function selection mode.

**Input signal:** The external input line must be connected to GND for a minimum of 30 msec.

- When the input signal is ON, the screen will display [ooo] for 1 second.
- After turning OFF the input signal, flow accumulation resumes (displays peak value and bottom value) within 30 msec.
- To input successive signals, the [ooo] display must clear before the next signal is input.

## ■ [F22] Setting of analogue output

This function is available when the model includes the analogue output.

The flow value corresponding to an analogue output voltage = 5 V or analogue output current = 20 mA can be selected.

\*: When using a model without analogue outputs, this setting is not available and [---] will be displayed.

<Operation>

Press the or button in function selection mode to display [F22].

[F22] and [FrE] are displayed in turn.

Displayed in turn  
 ↔

↓ Press the button.

### Setting of analogue output

[FrE] and [the current set value] are displayed in turn.

Displayed in turn  
 ↔   
 Analogue output      Set value

Press the or button to select.

↔   
 Variable range      Variable range  
 OFF                      ON

Select [oFF].  
 Press the button to set.

Select [oN].  
 Press the button to set.

### Set value

[F\_H] and [the current set value] are displayed in turn.

Displayed in turn  
 ↔   
 Set value

Use the and buttons to enter the flow value that will generate full span analogue output (5 V or 20 mA).  
 The entered flow value can be in the range: 10% of the maximum rated flow, to the max. displayable range.

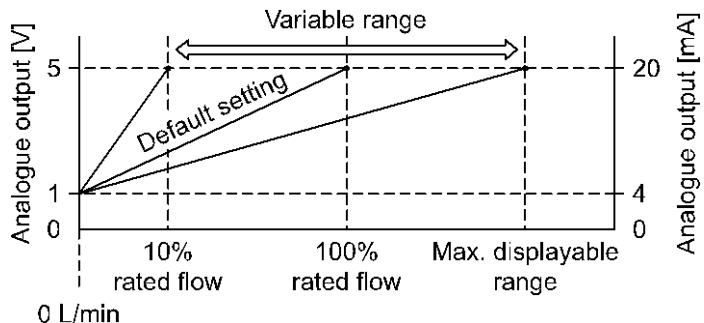

↓ Press the button to set.

[F22] Setting of analogue output completed.  
 Return to function selection mode.

\*: The above example is for the 500 L/min type.

## ■ [F30] Accumulated value hold

This function enables the accumulated flow value to be stored in permanent memory every 2 or 5 minutes. In the default setting, the accumulated flow value is not held when the power supply is turned off.

\*: When using the accumulated value hold function, calculate the product life from the operating conditions, and use the product within its life. The maximum access limit of the memory device is 1 million cycles. If the product is operated 24 hours per day, the product life will be as follows:

- Data memorized every 5 minutes --- 5 minutes x 1 million times = 5 million minutes = 9.5 years
- Data memorized every 2 minutes --- 2 minutes x 1 million times = 2 million minutes = 3.8 years

If the accumulated flow external reset is also repeatedly used, the product life will be shorter.

### <Operation>

Press the or button in function selection mode to display [F30].

[F30] and [SAv] are displayed in turn.



↓ Press the button.

### Accumulated value hold

[SAv] and [the current set value] are displayed in turn.

Press the or button to select.

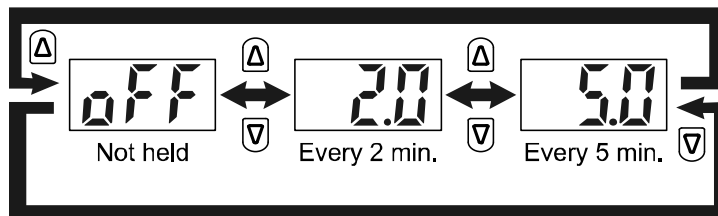
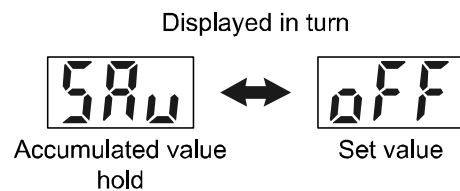

↓ Press the button to set.

[F30] Setting of accumulated value hold completed.  
Return to function selection mode.

\*: The value is stored in memory every 2 or 5 minutes. If the power supply is turned off, the accumulated flow since the last time it was stored will be lost.

\*: When the power supply is turned on again, the accumulated flow count will start from the last value recorded at B.

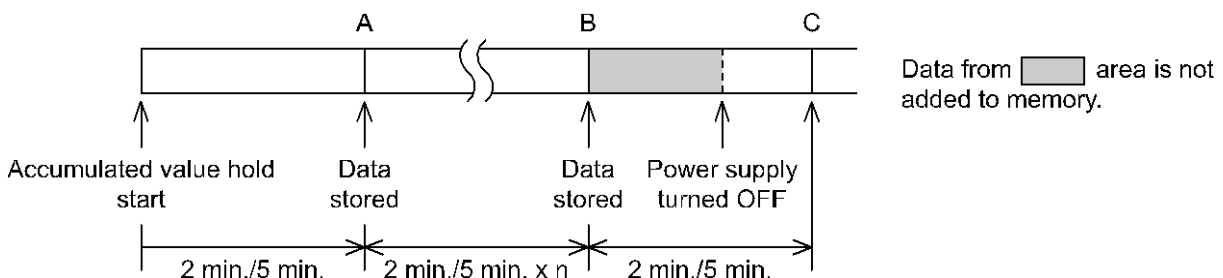



## ■ [F31] Orientation correction function

This function can correct a display error of flow caused by the mounting orientation.

If the product is mounted vertically, the displayed flow rate will be seriously affected around a zero flow rate and when the fluid pressure is high. This function can be used to reduce the display error that occurs when the product is mounted vertically.

<Operation>

Press the  or  button in function selection mode to display [F31].

[F31] and [PoS] are displayed in turn.

Displayed in turn

F31 ↔ PoS

↓ Press the  button.

### Orientation

[PoS] and [the current set value] are displayed in turn.

Press the  or  button to select.

Displayed in turn

PoS ↔ Hor  
Orientation Set value

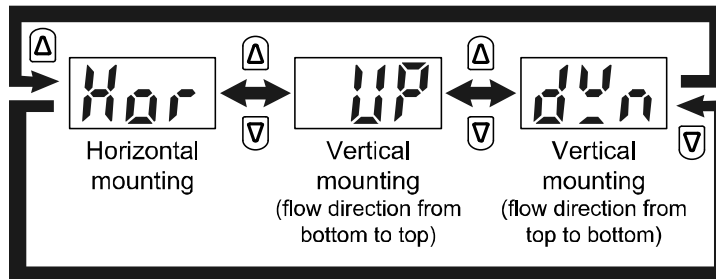

↓ Press the  button to set.

### Supply pressure

[PrS] and [the current set value] are displayed in turn.

Press the  or  button to select.

Displayed in turn

PrS ↔ n id  
Supply pressure range Set value

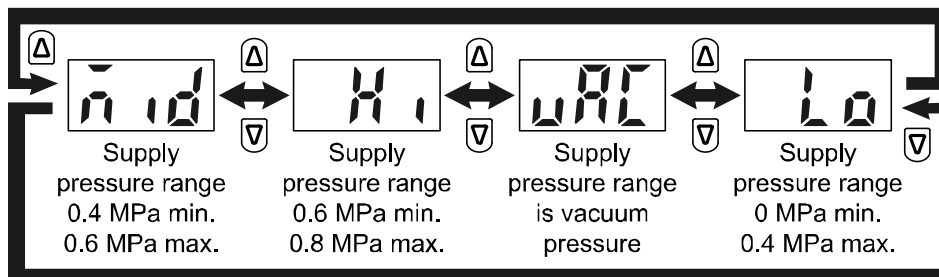

↓ Press the  button to set.



[F31] Setting of the orientation correction function completed.  
Return to function selection mode.



## ■[F80] Display OFF mode

This function will turn the display OFF if no buttons are pressed for 30 seconds.

<Operation>

Press the  or  button in function selection mode to display [F80].

[F80] and [dSP] are displayed in turn.

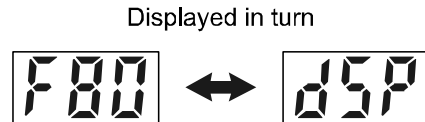

↓ Press the  button.

### Display OFF mode

[dSP] and [the current set value] are displayed in turn.

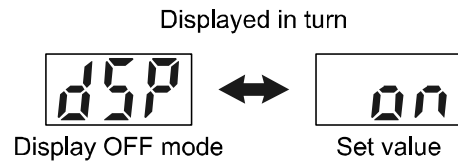

Press the  or  button to select.

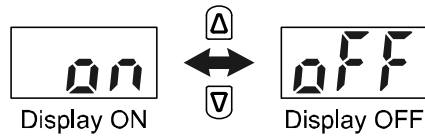

↓ Press the  button to set.

[F80] Setting of display OFF mode is completed.  
Return to function selection mode.

\*: In display OFF mode, the decimal points will flash.



\*: When any button is operated, the display will turn on. If no button operation is performed for another 30 seconds, the display will turn off again.



## ■ [F81] Security code

A security code can be selected, which must be entered to unlock the keys.  
For the key-lock function, refer to page 55.

<Operation>

Press the  or  button in function selection mode to display [F81].

[F81] and [Pin] are displayed in turn.

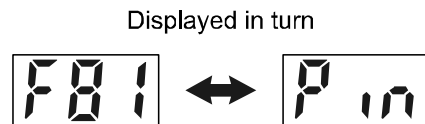

↓ Press the  button.

### Security code

[Pin] and [the current set value] are displayed in turn.

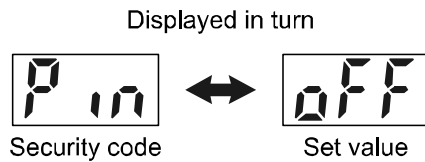

Press the  or  button to select.

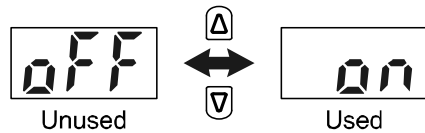

↓ Press the  button to set.

[F81] Setting of security code completed.  
Return to function selection mode.

## ■ [F90] Setting of all functions

All functions can be set one after the other, without having to select each one separately in function selection mode.

<Operation>

Press the  $\Delta$  or  $\nabla$  button in function selection mode to display [F90].

[F90] and [ALL] are displayed in turn.

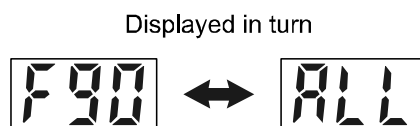

↓ Press the  $S$  button.

### Setting of all functions

[ALL] and [the current set value] are displayed in turn.

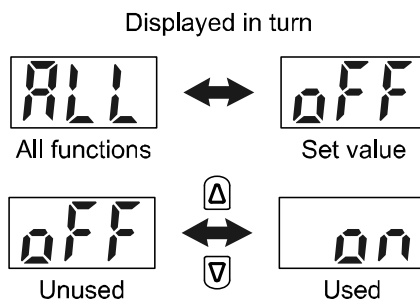

Press the  $\Delta$  or  $\nabla$  button to select.

Select [oFF].  
Press the  $S$  button to set.

Select [on].  
Press the  $S$  button to set.

Refer to "Order of function settings" (next page).  
Press the  $\Delta$  or  $\nabla$  button to select.  
Each time the  $S$  button is pressed, the function steps in the order shown in the following table.  
Follow the specified procedure for each function.  
\*: Press the  $S$  button for 2 seconds or longer to return to measurement mode.

[F90] Setting of all functions completed.  
Return to function selection mode.

### Order of function settings

Order	Function	Applicable model
1	[r EF] Reference condition	All models
2	[Un i] Unit selection function	Model with unit selection function
3	[oU1] OUT1 Output mode	All models
4	[1ot ] OUT1 Switch operation	All models
5	[ ] OUT1 Set value	All models
6	[ ] OUT1 Hysteresis	All models
7	[CoL] OUT1 Display colour	All models
8	[oU2] OUT2 Output mode	Models with NPN2 output, PNP2 output
9	[2ot ] OUT2 Switch operation	
10	[ ] OUT2 Set value	
11	[ ] OUT2 Hysteresis	
12	[r ES] Response time	All models
13	[FLo] Display mode	All models
14	[r Ev] Reversed display mode	All models
15	[ inP] External input	Model with external input function
16	[Fr E] Setting of analogue output	Model with analogue output function
17	[SAv] Accumulated value hold	All models
18	[PoS] Orientation	All models
19	[Pr S] Supply pressure	All models
20	[dSP] Display OFF mode	All models
21	[P in] Security code	All models

## ■ [F98] Output check

The operation of the output can be checked by switching the output ON/OFF by pressing a button, without the need for a flow of fluid.

<Operation>

Press the  $\Delta$  or  $\nabla$  button in function selection mode to display [F98].

[F98] and [tES] are displayed in turn.

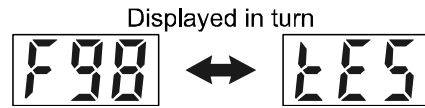

↓ Press the  $S$  button.

### Output check

[tES] and [the current set value] are displayed in turn.

Press the  $\Delta$  or  $\nabla$  button to select.

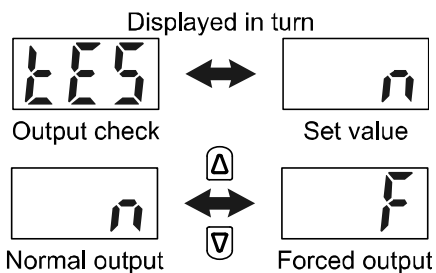

Select [ n ].  
Press the  $S$  button to set.

Select [ F ].  
Press the  $S$  button to set.

### Check of OUT1

[10U] and [the current set value] are displayed in turn.

Press the  $\Delta$  or  $\nabla$  button to select.

Changing the display between ON and OFF using the  $\Delta$  or  $\nabla$  button also changes the output status.

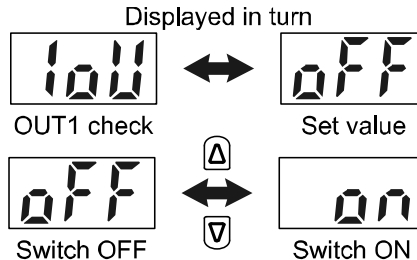

Press the  $S$  button.  
(With OUT2)

Press the  $S$  button.  
(Without OUT2)

### Check of OUT2

[20U] and [the current set value] are displayed in turn.

OUT2 can be set using the same procedure as OUT1.

For the analogue output type, 5 V or 20 mA is output when [on], and 1 V or 4 mA is output when [off].

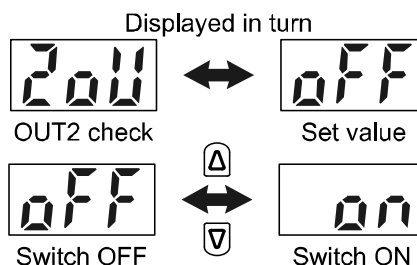

Press the  $S$  button.



[F98] Setting of output check completed.  
Return to function selection mode.

\*: An increase or decrease in flow will have no effect on the output while the output check is being performed.

## ■ [F99] Reset to the default settings

The product can be returned to the default settings.

<Operation>

Press the  or  button in function selection mode to display [F99].

[F99] and [ini] are displayed in turn.

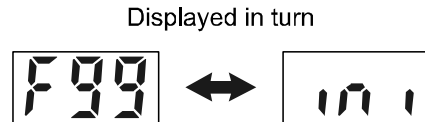



↓ Press the  button.

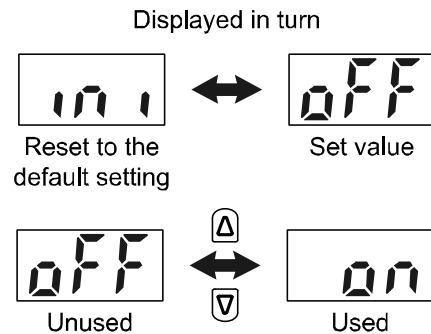

### Reset to the default settings

[ini] and [the current set value] are displayed in turn.

Press the  or  button to select.



Select [oFF].  
Press the  button.

Select [on].  
Press the  and  buttons  
simultaneously for 5 seconds or longer.

Return to function selection mode.

[F99] Reset to the default settings completed.  
Return to function selection mode.

## Other Functions

### ●Peak/Bottom value display



The maximum (minimum) flow from when the power was supplied to this moment is detected and updated. In peak/bottom display mode, the maximum (minimum) flow is displayed

●For peak display, when the  button is pressed for 1 second or longer, [the maximum flow] and [Hi] are displayed in turn.

To release holding the display of the maximum flow, press the  button for 1 second or longer again to return to measurement mode.



●For bottom display, when the  button is pressed for 1 second or longer, [the minimum flow] and [Lo] are displayed in turn.

To release holding the display of the minimum flow, press the  button for 1 second or longer again to return to measurement mode.



If the  and  buttons are pressed simultaneously for 1 second or longer while the flow value is being held, the peak (bottom) values are reset.

### ●Reset operation

The accumulated flow value can be reset, when displaying the accumulated flow.

To reset the accumulated flow, press the  and  buttons simultaneously for 1 second or longer.

The peak/bottom value can be reset, when displaying the peak value (bottom value).

To reset the peak/bottom value, press the  and  buttons simultaneously for 1 second or longer.

### ●Key lock

The key lock function is used to prevent errors occurring due to unintentional changes of the set values.

#### Valid operations when keys are locked

When the **[S]** button is pressed, the display will scroll through in the order of [LoC], [Set value] and [LoC]. And then return to measurement mode.

Press the **[S]** button for 1 second or longer to display [LoC] for 1 second.

<Operation-Without security code input->

### ●Locking

1. Press and hold the **[S]** button for 5 seconds or longer in measurement mode. [UnL] is displayed.

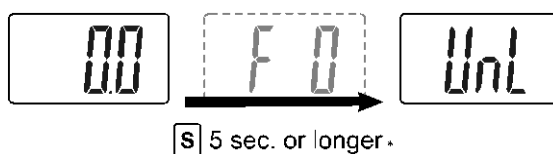

\*: Keep pressing the button even when [F 0] is displayed.

2. Press the **[Δ]** or **[▽]** button to select keys lock [LoC].

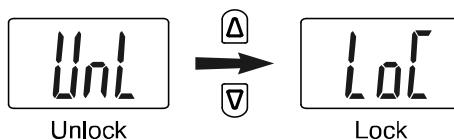

3. Press the **[S]** button to lock the keys and return to measurement mode.

### ●Unlocking

1. Press and hold the **[S]** button for 5 seconds or longer in measurement mode. [LoC] is displayed.

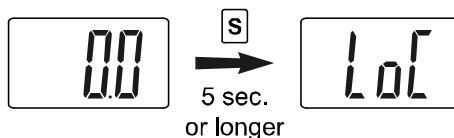

2. Press the **[Δ]** or **[▽]** button to select keys unlock [UnL].

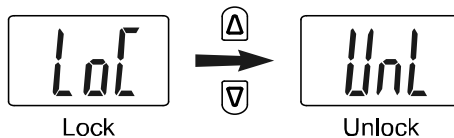

3. Press the **[S]** button to unlock the keys and return to measurement mode.



<Operation-With security code input->

Make [F81] Security code valid in advance.

**•Locking**

1. Press and hold the **[S]** button for 5 seconds or longer in measurement mode. [UnL] will be displayed.

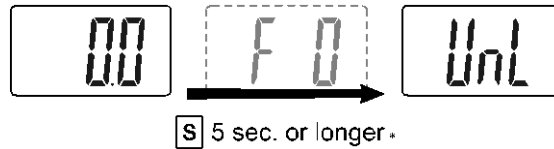

\*: Keep pressing the button even when [F 0] is displayed.

2. Press the **[Δ]** or **[▽]** button to select keys lock [LoC].

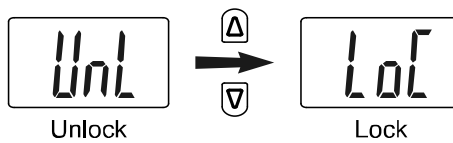

3. Press the **[S]** button to lock the keys and return to measurement mode.

**•Unlocking**

1. Press and hold the **[S]** button for 5 seconds or longer in measurement mode. [LoC] will be displayed.

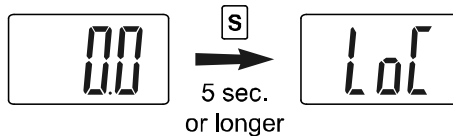

2. Press the **[Δ]** or **[▽]** button to select keys unlock [UnL].

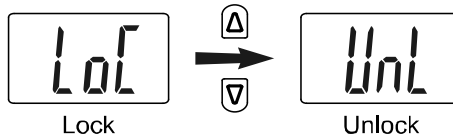

3. After the **[S]** button is pressed, the security code must be entered.

**Enter of security code**

The first digit will start flashing. Press the **[Δ]** or **[▽]** button to select a value.

Press the **[S]** button to set, and the next digit to the right will start flashing.

If the **[S]** button is pressed at the last digit, the first digit will start flashing.

\*: The default security code is [000].



4. After the setting is completed, press and hold the **[S]** button for 1 second or longer.  
 If the security code entered is correct, [UnL] will be displayed.  
 If the security code entered is incorrect, [FAL] will be displayed and the security code must be entered again.  
 If an incorrect security code is entered 3 times, [LoC] will be displayed and return to measurement mode.

5. Press any of the **[Δ]**, **[S]** or **[▽]** buttons to release the key lock and return to measurement mode.

\*: If a key is not pressed for 30 seconds while entering the security code, return to measurement mode.

## Change of security code

In the default setting, the security code is set to [000], but this can be changed to any number.

<Operation>

1. When the key lock has been set, perform the key unlocking procedure (step 4).
2. After the display changes to [UnLoC], press and hold the **S** and **V** buttons simultaneously for 5 seconds or longer.  
A new security code can now be entered.
3. Enter a new security code.  
The first digit will start flashing. Press the **Δ** or **▽** button to select a value.  
Press the **S** button to set, and the next digit to the right will start flashing.  
If the **S** button is pressed at the last digit, the first digit will start flashing.



4. After the setting is completed, press and hold the **S** button for 1 second or longer.  
The display will stop flashing, and the new security code will be displayed.  
At this time, if the **Δ** or **▽** buttons are pressed, any security code changes are lost, and the change of security code must be repeated.
5. After checking the security code is as required, press the **S** button for 1 second or longer.  
The new security code is set and return to measurement mode.

## Maintenance

### **How to reset the product after a power cut or when the power has been unexpectedly removed**

The settings of the product are retained from before the power cut or de-energizing.

The output condition also recovers to that before power cut or de-energizing, but may change depending on the operating environment. Therefore, check the safety of the whole installation before operating the product.

## Troubleshooting

If an operation failure of the product occurs, please confirm the cause of the failure from the following table. If a cause applicable to the failure cannot be identified and normal operation can be recovered by replacement with a new product, this indicates that the product itself was faulty. Problems with the product may be due to the operating environment (installation etc). Please consult SMC.

### ●Cross-reference for troubleshooting





	Fault	Possible cause	Countermeasures
Display	No display.	Incorrect wiring.	Correct the wiring.
	[Hi]/[Lo] is displayed in turn.	Peak (Bottom) value display function has been selected.	Refer to Peak/Bottom value display (page 54) and turn off the function.
	The display is unstable.	Foreign matter in the sensor.	Install a filter or mist separator on the IN side if there is a risk of foreign matter entering the product. If there is foreign matter on the mesh, remove it completely, taking care not to damage the product.
		The piping is connected in the wrong direction.	Mount the product so that the flow direction is the same as the arrow indicated on the side of the body or the product label.
		Pulsation in the flow.	It is possible that pulsation is generated due to the fluctuation of the supply pressure or the characteristics of the compressor or pump used as the pressure source. Change to a pressure source with less fluctuation or install a tank which reduces the pressure fluctuation.
		Air leakage.	Correct the piping.
	Incorrect display.	Foreign matter in the sensor.	Install a filter or mist separator on the IN side if there is a risk of foreign matter entering the product. If there is foreign matter on the mesh, remove it completely, taking care not to damage the product.
		The piping is connected in the wrong direction.	Mount the product so that the flow direction is the same as the arrow indicated on the side of the body or the product label.
		Incorrect units selected. *	Select the correct unit using the unit selection function.
		Air leakage.	Correct the piping.

\*: Product with unit selection function.

Fault		Possible cause	Countermeasures
Output	No output.	Incorrect wiring.	Correct the wiring.
	Output is unstable.	Foreign matter in the sensor.	Install a filter or mist separator on the IN side if there is a risk of foreign matter entering the product. If there is foreign matter on the mesh, remove it completely, taking care not to damage the product.
		The piping is connected in the wrong direction.	Mount the product so that the flow direction is the same as the arrow indicated on the side of the body or the product label.
		Pulsation in the flow.	It is possible that pulsation is generated due to the fluctuation of the supply pressure or the characteristics of the compressor or pump used as the pressure source. Change to a pressure source with less fluctuation or install a tank which reduces the pressure fluctuation.
		Air leakage.	Correct the piping.
		Hysteresis is too small.	Increase the hysteresis.
Button	The buttons do not operate.	Key lock mode is activated.	Unlock the keys (page 55).
External input	The external input is not accepted (no reaction). *	Incorrect wiring.	Correct the wiring.
		The input time is too short.	When the external input is applied, the input line must be connected to GND for a minimum of 30 msec.
		Input interval is too short.	To input signals successively, wait for at least 1 second before inputting the next signal.

\*: Product with external input function.

## ■ Error indication

Error name	Error display	Description	Measures
Instantaneous flow error	HHH	The flow has exceeded the upper limit of the flow display range.	Reduce the flow.
	LLL	Fluid is flowing in the reverse direction by at least -5% of the maximum rated flow value.	Connect the fluid flow in the correct direction.
OUT1 over current error	Er 1	The switch output (OUT1) load current has exceeded 80 mA.	Turn the power OFF and remove the cause of the over current. Then turn the power ON again.
OUT2 over current error	Er 2	The switch output (OUT2) load current has exceeded 80 mA.	
System error	Er 0	An internal data error has occurred.	Turn the power OFF and turn it ON again.
	Er 4		
	Er 6		
	Er 8		
Accumulated flow error	 Accumulated flow is displayed (Flashing)	The accumulated flow has exceeded the accumulated flow range. (For count up display)	Reset the accumulated flow. (Press the  and  buttons simultaneously for 1 second or longer.) (page 54)
	 Accumulated flow is displayed (Flashing)	The accumulated flow has reached the set accumulated flow value. (For count down display)	

\*: If the error cannot be reset after the above measures are taken, then please contact SMC.

# Specification

## ■ Specifications

Model		PFMB7501	PFMB7102	PFMB7202	
Fluid	Applicable fluid	Air, N <sub>2</sub> (Air quality: ISO8573-1 1.1.2 to 1.6.2 *1)			
	Fluid temperature range	0 to 50 °C			
Flow	Detecting method	Heating type sensor			
	Rated flow range	5 to 500 L/mim	10 to 1000 L/mim	20 to 2000 L/mim	
	Set flow rate range	Instantaneous flow	5 to 525 L/mim	10 to 1050 L/mim	20 to 2100 L/mim
		Accumulated flow	0 to 999,999,990 L		
	Minimum setting unit	Instantaneous flow	1 L/min		
		Accumulated flow	10 L		
	Accumulated volume per pulse (Pulse width = 50 msec.)	1 L/pulse	10 L/pulse		
	Accumulated value hold *2	Every 2 minutes or every 5 minutes			
Pressure	Rated pressure range	0 to 0.8 MPa			
	Proof pressure	1.2 MPa			
	Pressure loss	Refer to the pressure loss graph.			
	Pressure characteristics *3	±5%F.S. (0 to 0.8 MPa, 0.6 MPa standard)			
Electrical	Power supply voltage	12 to 24 VDC ±10% Ripple (p-p) 10% or less			
	Current consumption	55 mA or less			
	Protection	Polarity protection			
Accuracy	Display accuracy	±3%F.S.			
	Analogue output accuracy	±3%F.S.			
	Repeatability	±1%F.S. (±2%F.S. when response time is set to 0.05 second)			
	Temperature characteristics	±5%F.S. (0 to 50 °C, 25 °C standard)			
Switch output	Output type	NPN open collector or PNP open collector			
	Output mode	Hysteresis mode, Window comparator mode, Accumulated output mode or Accumulated pulse output mode			
	Switch operation	Normal output Reversed output			
	Maximum load current	80 mA			
	Maximum applied voltage (Only NPN)	28 VDC			
	Internal voltage drop (Residual voltage)	NPN output: 1 V or less (at 80mA) PNP output: 1.5 V or less (at 80mA)			
	Response time *4	0.05 sec., 0.1 sec., 0.5 sec., 1 sec. or 2 sec.			
	Hysteresis *5	Variable			
Protection	Short circuit protection				

Model		PFMB7501	PFMB7102	PFMB7202	
Analogue output *6	Output type		Voltage output: 1 to 5 V, Current output: 4 to 20 mA (Refer to analogue output graph)		
	Impedance	Voltage output	Output impedance approx. 1 kΩ		
		Current output	Maximum load impedance: 600 Ω at 24 VDC 300 Ω at 12 VDC		
	Response time *7		Linked with the response time of the switch output.		
Ext. input *8	External input specification		Input voltage: 0.4 V or less (reed or solid state type) for 30 msec. or longer		
	Input mode		Accumulated flow external reset or peak/bottom hold value		
Display	Reference condition *9		Normal condition or Standard condition		
	Display mode		Instantaneous flow or Accumulated flow		
	Unit *10	Instantaneous flow	L/min, cfm		
		Accumulated flow	L, ft <sup>3</sup>		
	Displayable range	Instantaneous flow	-25 to 525 L/min (Displays [ 0] when the value is between -4 and 4.)	-50 to 1050 L/min (Displays [ 0] when the value is between -9 and 9.)	-100 to 2100 L/min (Displays [ 0] when the value is between -19 and 19.)
		Accumulated flow	0~999,999,990 L		
	Minimum setting unit	Instantaneous flow	1 L/min		
		Accumulated flow	10 L		
	Display		4 digits, 7 segment, dual colour LCD display (red/green)		
	Indicator LED		LED is ON when switch output is ON (OUT1/OUT2: Orange)		
Environmental	Enclosure		IP40		
	Withstand voltage		1000 VAC for 1 minute between live parts and case		
	Insulation resistance		50 MΩ or more between live parts and case (with 500 VDC megger)		
	Operating temperature range		Operation: 0 to 50 °C, Storage: -10 to 60 °C (No condensation or freezing)		
	Operating humidity range		Operation, Storage: 35 to 85%RH (No condensation or freezing)		
Standards		CE, RoHS			
Piping port sizes		Rc1/2, NPT1/2, G1/2		Rc3/4, NPT3/4, G3/4	
Main materials of parts in contact with fluid		ADC, PPS, SUS304, gold, HNBR, silicone Glass-cloth epoxy resin			
Weight	Piping port sizes		100 g		155 g
	Lead wire		+35 g		
	Bracket		+25 g		+30 g



\*1: It is possible to satisfy the air quality class indicated in the specification using the pneumatic circuit below.

**Recommended pneumatic circuit example (Compressed air)**

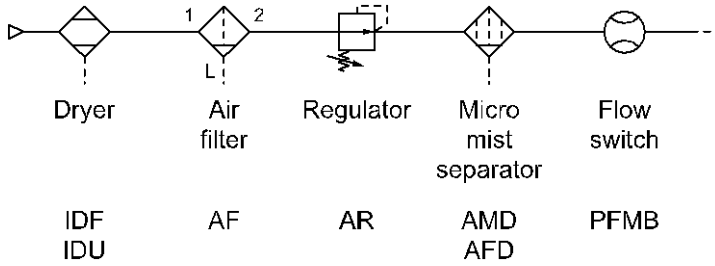

\*2: When using the accumulated value hold function, calculate the product life from the operating conditions, and use the product within its life. The maximum access limit of the memory device is 1 million cycles. If the product is operated 24 hours per day, the product life will be as follows:

- Data memorized every 5 minutes --- 5 minutes x 1 million times = 5 million minutes = 9.5 years
- Data memorized every 2 minutes --- 2 minutes x 1 million times = 2 million minutes = 3.8 years

If the accumulated flow external reset is also repeatedly used, the product life will be shorter.

- \*3: Do not release the OUT side piping port of the product directly to the atmosphere without connecting piping. If the product is used with the piping port open to atmosphere, accuracy may vary.
- \*4: The time from when the flow is changed as a step input (when the flow rate changes from 0 to the maximum flow of rated flow range instantaneously) until the switch output turns ON (or OFF) at 90% of the rated flow rate.
- \*5: If the flow fluctuates around the set value, the hysteresis must be set to more than the fluctuation width. Otherwise, chattering will occur.
- \*6: This function is available for models with analogue output.
- \*7: The time from when the flow is changed as a step input (when the flow rate changes from 0 to the maximum flow instantaneously) until the analogue output reaches 90% of the rated flow rate.
- \*8: This function is available for models with external input.
- \*9: The flow rate given in the specification is the value at standard condition (ANR).
- \*10: Setting is only possible for models with the unit selection function.

**Cable specification: Lead wire with connector (ZS-33-D)**

Item		Specifications
Conductor	Nominal cross section	AWG26
Insulator	Outside diameter	Approx. 1.00 mm
	Colours	Brown, White, Black, Blue
Sheath	Outside diameter	φ3.5 +0.10 -0.25

## ■ Characteristics data

### ● Analogue output

	A	B	C
Voltage output	1 V	1.04 V	5 V
Current output	4 mA	4.16 mA	20 mA

Model	Minimum flow of rated flow range	Maximum flow of rated flow range
PFMB7501	5 L/min	500 L/min
PFMB7102	10 L/min	1000 L/min

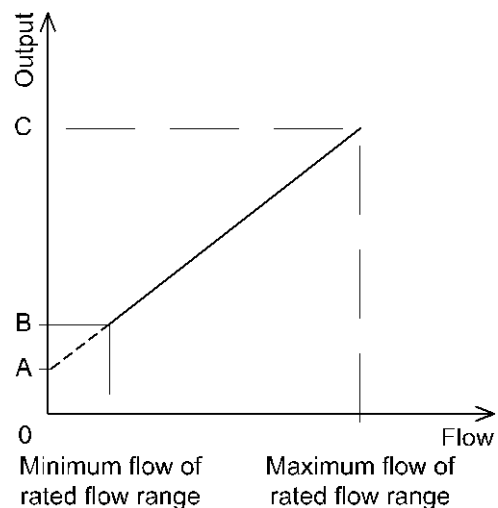

### ● Pressure loss

PFMB7501 (500L/min用)

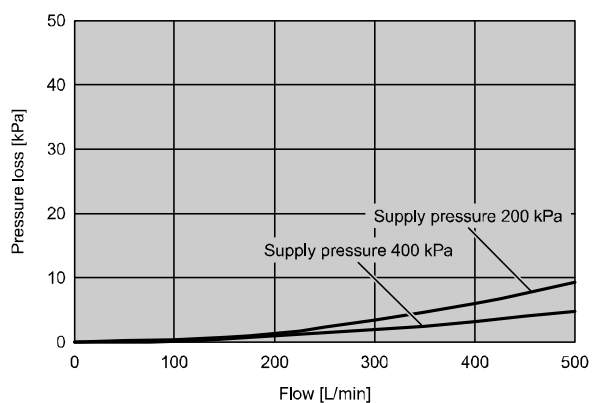

PFMB7102 (1000L/min用)

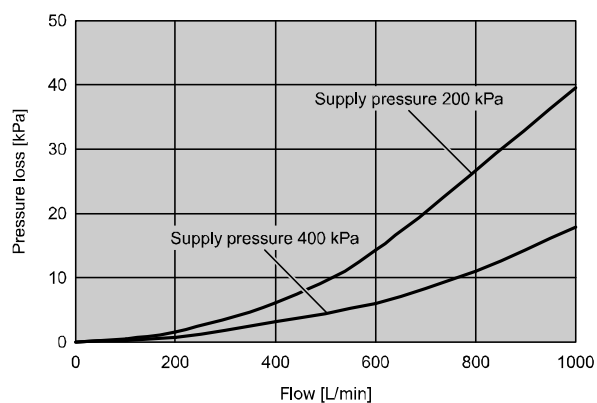

PFMB7202 (2000L/min用)

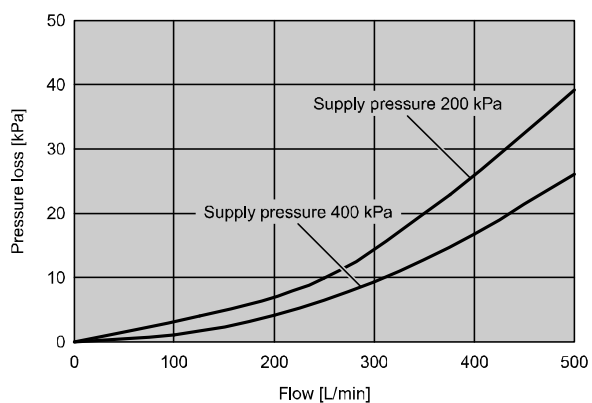

●Straight inlet piping length and accuracy (reference value)

- The smaller the piping size, the more the product is affected by the straight piping length.
- The smaller the flow rate, the less the product is affected by the straight piping length.
- The straight piping length shall be 8 cm or longer in order to maintain  $\pm 3\%$ F.S. of the specification.

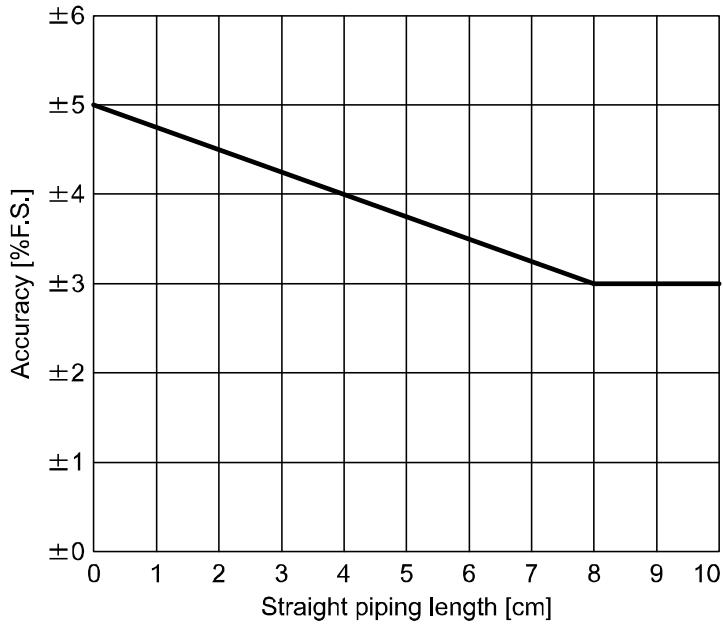
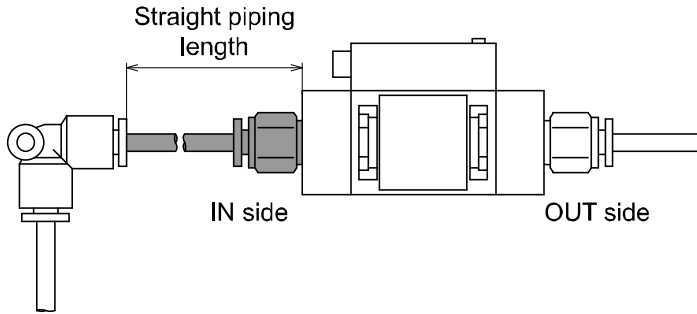

■ Dimensions (in mm)

PFMB7501/7102/7202

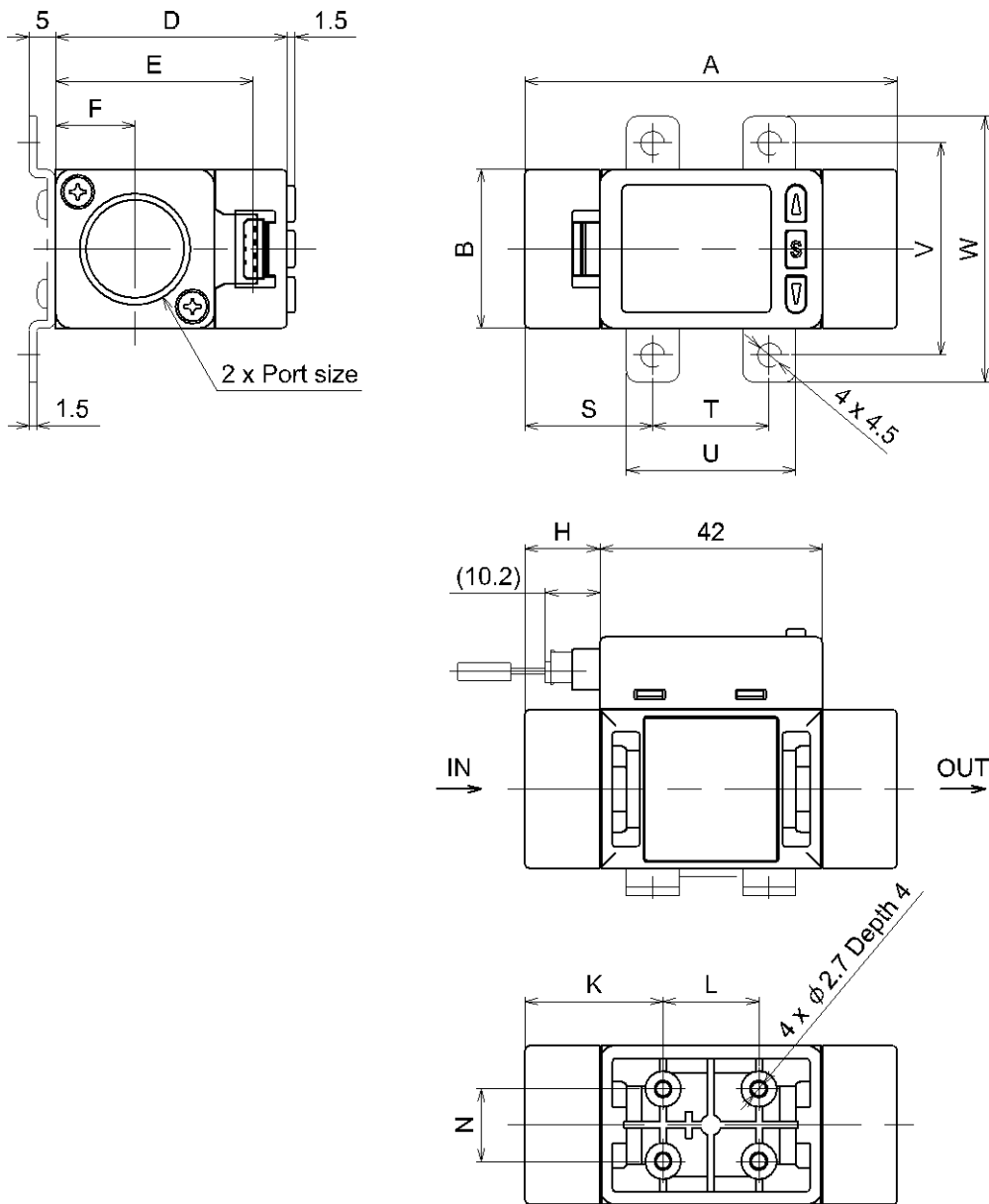

Model \ Symbol	A	B	D	E	F	H	K	L	N
PFMB7501/7102	70	30	43.7	37.2	15	14	26	18	13.6
PFMB7202	90	35	49.2	42.7	17.5	24	31	28	16.8

Model \ Symbol	Bracket dimensions				
	S	T	U	V	W
PFMB7501/7102	24	22	32	40	50
PFMB7202	30	30	42	48	58

Lead wire with connector (ZS-33-D)

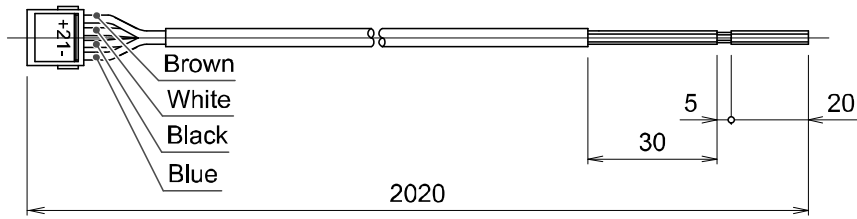

Connector cover (ZS-33-F)

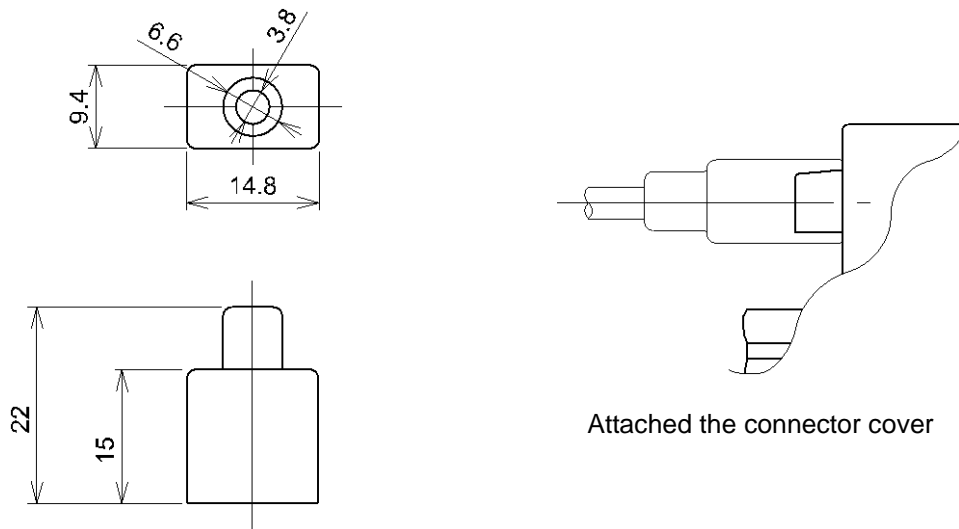

#### Revision history

A: Modified errors in text.  
B: Revision.  
C: Contents revised in several place.  
D: Contents are added.  
E: Modified errors in text.  
F: Modified errors in text.  
G: Contents revised in several places.  
[September 2016]  
H: Contents revised in several places.  
[August 2018]

## SMC Corporation

4-14-1, Sotokanda, Chiyoda-ku, Tokyo 101-0021 JAPAN

Tel: + 81 3 5207 8249 Fax: +81 3 5298 5362

URL <http://www.smcworld.com>

---

Note: Specifications are subject to change without prior notice and any obligation on the part of the manufacturer.

© 2012-2018 SMC Corporation All Rights Reserved

