



Operation Manual

Installation · Operation

Original Instructions

Thermo Chiller

HRS Series

HRS200-A*-46-*S* 

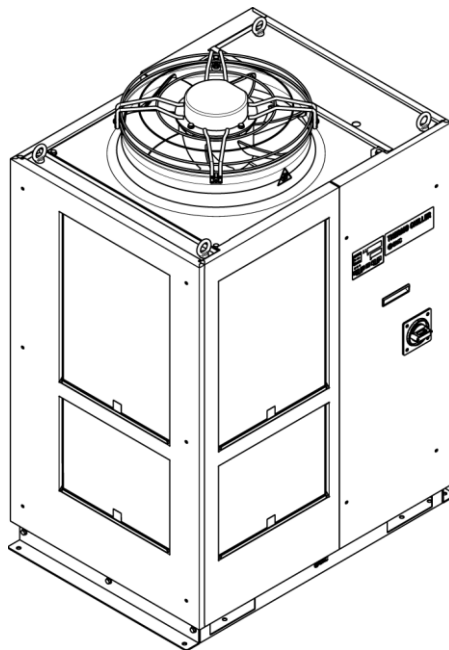

Keep this manual available whenever necessary

To the users

Thank you for purchasing SMC's Thermo chiller (hereinafter referred to as the "product"). For safety and long life of the product, be sure to read this operation manual (hereinafter referred to as the "manual") and clearly understand the contents.

- Be sure to read and follow all instructions noted with "Warning" or "Caution" in this manual.
- This manual is intended to explain the installation and operation of the product. Only people who understand the basic operation of the product through this manual or who perform installation and operation of or have basic knowledge about industrial machines are allowed to work on the product.
- This manual and other documents attached to the product do not constitute a contract, and will not affect any existing agreements or commitments.
- It is strictly prohibited to copy this manual entirely or partially for the use by a third party without prior permission from SMC.

Note: This manual is subject to possible change without prior notice.

Contents

Chapter 1	Safety Instructions	1-1
1.1	Before Using the Product	1-1
1.2	Reading the Manual	1-1
1.3	Hazards	1-2
1.3.1	Level of hazards	1-2
1.3.2	Definition of "Serious injury" and "Minor injury"	1-2
1.4	Product Label	1-3
1.5	Safety Measures	1-4
1.5.1	Safety instructions for use	1-4
1.5.2	Personal protective equipment	1-4
1.6	Emergency Measures	1-5
1.7	Waste Disposal	1-5
1.7.1	Disposal of refrigerant and compressor oil	1-5
1.7.2	Disposal of product	1-5
1.8	Material Safety Data Sheet (MSDS)	1-6
Chapter 2	Name and Function of Parts	2-1
2.1	Model Number of Product	2-1
2.2	Name and Function of Parts	2-2
2.3	Function of Parts	2-3
2.4	Operation Display Panel	2-4
Chapter 3	Transport and Setting Up	3-1
3.1	Transport	3-1
3.1.1	Transportation using forklift and hanging	3-2
3.1.2	Transportation using casters	3-3
3.2	Installation	3-4
3.2.1	Environment	3-4
3.2.2	Operation at low ambient temperature or low circulating fluid temperature	3-6
3.2.3	Location	3-7
3.2.4	Installation and maintenance space	3-8
3.3	Installation	3-9
3.3.1	Installation	3-9
3.3.2	Electrical wiring	3-11
3.3.3	Preparation and wiring of power supply cable	3-13
3.3.4	Contact input/output communication wiring	3-17
3.3.5	Wiring of run/stop signal input and remote signal input	3-17
3.3.6	Wiring of external switch signal input	3-20
3.3.7	Wiring of contact output signal	3-23

3.3.8	RS-485 communication wiring	3-24
3.3.9	RS-232C communication wiring	3-25
3.4	Piping	3-26
3.5	Circulating Fluid Supply.....	3-29
3.5.1	Automatic water fill function.....	3-29
3.5.2	Fluid supply without using the automatic water fill function.....	3-31
3.5.3	Option K “Water fill port”	3-33
Chapter 4	Starting the Product.....	4-1
4.1	Before Starting	4-1
4.2	Preparation for Start	4-2
4.2.1	Power supply	4-2
4.2.2	Setting of circulating fluid temperature	4-2
4.3	Preparation of Circulating Fluid Supply to User’s Equipment	4-3
4.4	Operation Start and Stop	4-6
4.4.1	Starting the product	4-6
4.4.2	Stopping the product.....	4-7
4.5	Check Items during Startup	4-8
4.6	Adjustment of Circulating Fluid Flow Rate	4-8
Chapter 5	Display and Setting of Various Functions	5-1
5.1	List of Functions	5-1
5.2	Function.....	5-2
5.2.1	Key operations.....	5-2
5.2.2	List of parameters.....	5-4
5.3	Main Display	5-7
5.3.1	Main display.....	5-7
5.3.2	Items on the main display.....	5-7
5.4	Alarm Menu	5-8
5.4.1	Alarm menu	5-8
5.4.2	Items shown on the alarm menu display	5-8
5.5	Check Monitor Menu.....	5-9
5.5.1	Check monitor menu.....	5-9
5.5.2	Checking with the check monitor menu.....	5-9
5.6	Key-lock.....	5-13
5.6.1	Key-lock.....	5-13
5.6.2	Key-lock setting / checking	5-14
5.7	Run Timer and Stop Timer Function	5-15
5.7.1	Run timer and stop timer function.....	5-15
5.7.2	Setting and checking of run timer and stop timer function	5-17
5.8	Ready Completion (TEMP READY) Signal.....	5-19

5.8.1	Ready completion (TEMP READY) signal	5-19
5.8.2	Ready completion (TEMP READY) signal setting / checking	5-20
5.9	Offset Function	5-22
5.9.1	Offset function	5-22
5.9.2	Usage example of offset function	5-23
5.9.3	Setting/checking of offset function	5-25
5.10	Operation Restoration after Power Failure.....	5-27
5.10.1	Operation restoration function after power failure.....	5-27
5.10.2	Setting/checking of the operation restoration function	5-28
5.11	Anti-freezing Function	5-29
5.11.1	Anti-freezing function.....	5-29
5.11.2	Setting/checking of anti-freezing function	5-30
5.12	Key Operation Sound Setting	5-31
5.12.1	Key operation sound setting.....	5-31
5.12.2	Setting/checking of the key operation sound	5-31
5.13	Temperature Unit Change	5-32
5.13.1	Temperature unit change	5-32
5.13.2	Setting/checking of temperature unit change.....	5-32
5.14	Pressure Unit Change	5-33
5.14.1	Pressure unit change	5-33
5.14.2	Setting/checking of pressure unit change	5-33
5.15	Data Reset Function	5-34
5.15.1	Data reset function	5-34
5.15.2	How to operate reset function	5-34
5.16	Accumulated Operating Time Reset Function	5-35
5.16.1	Accumulated operating time reset function.....	5-35
5.16.2	How to operate accumulated operating time reset function.....	5-35
5.17	Warming Up Function.....	5-39
5.17.1	Warming up function	5-39
5.17.2	Setting/checking of warming up function.....	5-40
5.18	Anti-Snow Coverage Function.....	5-42
5.18.1	Anti-snow coverage function	5-42
5.18.2	Setting/checking of anti-snow coverage function.....	5-43
5.19	Alarm Buzzer Sound Setting.....	5-44
5.19.1	Alarm buzzer sound setting.....	5-44
5.19.2	Setting/checking of alarm buzzer sound	5-44
5.20	Alarm Customizing Function	5-45
5.20.1	Alarm customizing function	5-45
5.20.2	Setting and checking of the alarm customizing function	5-49
5.20.3	Setting of temperature alarm monitoring method and alarm generation timing.....	5-61

5.21	Communication Function.....	5-68
5.21.1	Communication function	5-68
5.21.2	Setting/checking of communication function	5-68
Chapter 6	Alarm Notification and Troubleshooting.....	6-1
6.1	Alarm Notification	6-1
6.2	Alarm Buzzer Stop	6-3
6.3	Troubleshooting.....	6-4
6.3.1	Alarm contents, causes, and troubleshooting	6-4
6.3.2	How to release the thermal relay trip and circuit protector trip	6-8
6.4	Other Errors.....	6-10
Chapter 7	Control, Inspection and Cleaning.....	7-1
7.1	Quality Control of Circulating Fluid and Facility Water.....	7-1
7.2	Inspection and Cleaning	7-2
7.2.1	Daily check	7-2
7.2.2	Monthly check.....	7-3
7.2.3	Inspection every 3 months.....	7-4
7.2.4	Inspection during winter season	7-6
7.3	Consumables	7-6
7.4	Operation Stop for an Extended Period of Time.....	7-7
7.4.1	Discharge of the circulating fluid.....	7-7
Chapter 8	Documents.....	8-1
8.1	Specifications.....	8-1
8.1.1	HRS200-A*-46-*S*	8-1
8.1.2	Refrigerant with GWP reference.....	8-2
8.1.3	Communication specifications	8-2
8.2	Dimensions.....	8-3
8.3	Flow Diagram	8-4
8.4	Cooling Capacity.....	8-5
8.5	Pump Capacity.....	8-5
8.6	Types of Hazard Labels.....	8-6
8.6.1	Positions of danger warning label.....	8-7
8.7	Standards	8-8
8.8	Sample DoC.....	8-9
8.9	Daily Check Sheet.....	8-10
Chapter 9	Product Warranty	9-1

Chapter 1 Safety Instructions



Before using the product, be sure to read and understand all the important actions highlighted in this manual.

1.1 Before Using the Product

- This chapter is intended to specifically describe the safety related issues for handling the product. Read this before handling the product.
- The product is a cooling device using circulating fluid. SMC does not take any responsibility for any problems that may arise from using the product for other purposes.
- This product is not designed for a clean room. It generates dust from the internal components such as pump and fan motor.
- The product is operated at high voltage and contains components which become hot and rotate. If a component needs to be replaced or repaired, contact a specialized vendor for parts and service.
- All personnel who work with or around the product should read and understand the safety related information in this manual carefully before starting work.
- The safety manager is responsible for strictly observing safety standards, but responsibility in respect to safety standards during daily work resides with each individual operator and maintenance personnel.
- Do not use the materials that rust or corrode for the circulating fluid and facility water circuits. Using the materials that tend to rust or corrode may cause clogs or/and leakages of the circulating fluid and facility water circuits. In case of using these kind of materials, consider and carry out some prevention against the rusting or corrosion on the customer side.
- This manual must be kept available to operators whenever necessary.

1.2 Reading the Manual

This manual contains symbols to help identify important actions when installing, operating or maintaining the product.



This sign indicates actions that must be followed.



This sign indicates prohibited actions.

1.3 Hazards

1.3.1 Level of hazards

The instructions given in this manual aim to assure the safe and correct operation of the product, and to prevent injury of operators or damage to the product. These instructions are grouped into three categories, Danger, Warning and Caution, which indicate the level of hazard, damage and also the degree of emergency. All safety critical information should be carefully observed at all times.

“DANGER”, “WARNING” and “CAUTION” signs are in order according to severity (DANGER> WARNING> CAUTION).

DANGER

“DANGER”: Hazard that **WILL** cause serious personal injury or death during operation.

WARNING

“WARNING”: Hazard that **MAY** cause serious personal injury or death during operation.

CAUTION

“CAUTION”: Hazard that **MAY** cause minor personal injury.

CAUTION

“CAUTION without exclamation symbol”: Hazard that **MAY** cause damage or failure of the product, facility, devices, etc.

1.3.2 Definition of “Serious injury” and “Minor injury”

■ “Serious injury”

This term describes injuries that result in after effects including loss of eyesight, burns, electric shock, fracture, poisoning, etc. and requires long-term treatment or hospitalization.

■ “Minor injury”

This term describes injuries that do not need long-term treatment or hospitalization. (Others excluded from “Serious injury”.)

1.4 Product Label

Information about the product, such as Serial No. and Model No. can be found on the product label. This information is needed when contacting an SMC sales distributor.

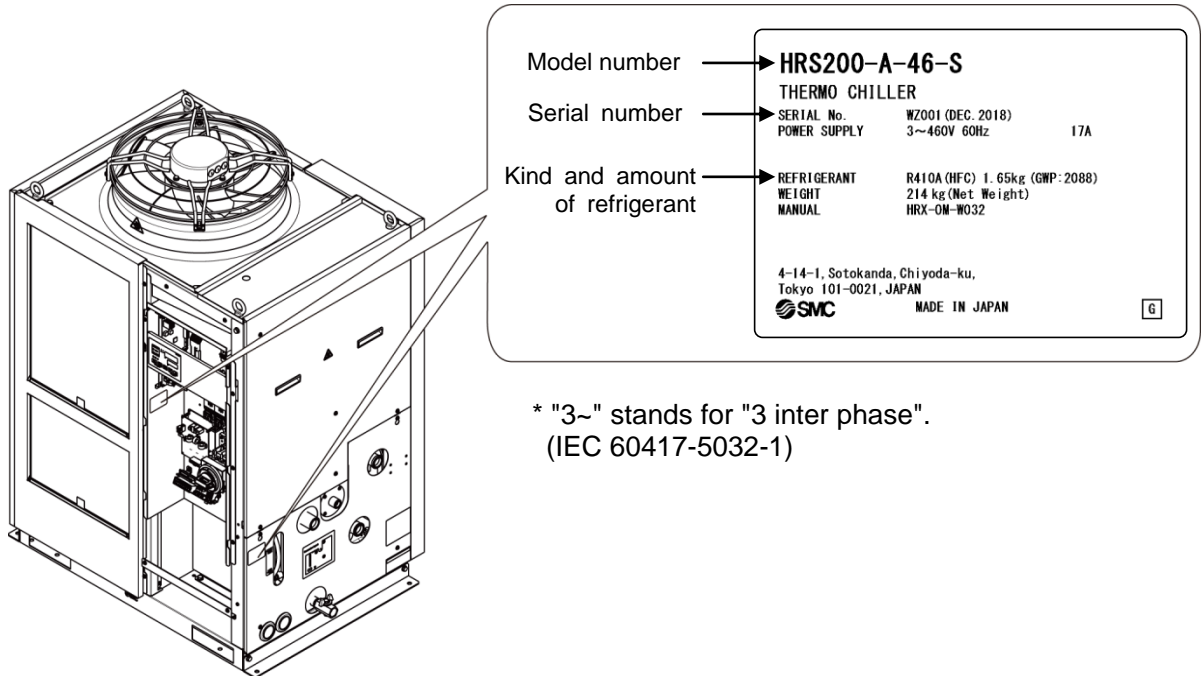

* "3~" stands for "3 inter phase".
(IEC 60417-5032-1)

How to see the serial number **W Z 001 (December 2018)**

W			Z			001
Year	Symbol	Remarks	Month	Symbol	Remarks	Serial no.
2018	W	Repeated from A to Z in alphabetical order	1	o	Repeated from O to Z in alphabetical order, with O for January and Z for December	—
2019	X		2	P		
2020	y		3	Q		
↓	↓		↓	↓		

Fig. 1-1 Position of the product label

1.5 Safety Measures

1.5.1 Safety instructions for use

⚠ WARNING

 **Follow the instructions below when using the product. Failure to follow the instructions may cause an accident and injury.**

- Read and understand this manual carefully before using the product.
- Before starting maintenance of the product, be sure to lock out and tag out the breaker of the user's power supply.
- If operating the product during maintenance, be sure to inform all workers nearby.
- Use only the correct tools and procedure when installing or maintaining the product.
- Use personal protective equipment where specified (“1.5.2 Personal protective equipment”).
- Check all parts and screws are fitted correctly and securely after maintenance.
- Avoid working in a drunken or sick condition, which might cause an accident.
- Do not remove the panels except for the cases permitted in this manual.
- Do not remove the panels during operation.
- Do not handle this product by any means other than specified in this Operation Manual; this can result in damage to the product or fire.

1.5.2 Personal protective equipment

This manual specifies personal protective equipment for each work.

■ Transport, Installing and Uninstalling

⚠ CAUTION

 **Always use safety shoes, gloves and head protection when transporting, installing or uninstalling the product.**

■ Handling of circulating fluid

⚠ CAUTION

 **Always use safety shoes, gloves, mask, apron and eye protection when handling the circulating fluid.**

■ Operation

⚠ CAUTION

 **Always use safety shoes and gloves when operating the product.**

1.6 Emergency Measures

When emergency conditions such as natural disaster, fire, earthquake and injury occur, shut off the breaker of the user's power supply that supplies power to the product.

WARNING



Even when the power supply switch is turned off, some of the internal circuits are still energized, unless the user's power supply is shut off. Be sure to shut off the breaker of the user's power supply.

1.7 Waste Disposal

1.7.1 Disposal of refrigerant and compressor oil

The product uses hydro fluorocarbon type refrigerant (HFC) and compressor oil. Comply with the laws and regulations in each country for the disposal of refrigerant and compressor oil. The type and quantity of refrigerant is described on the "1.4 Product Label".

If these fluids need to be recovered, read and understand the instructions below carefully. If there is any unclear point, contact an SMC's sales distributor.

WARNING



- Only maintenance personnel or qualified people are allowed to open the cover panels of the product.
- Do not mix the compressor oil with domestic waste for disposal. Also, the disposal of the waste must only be conducted by specific facilities that are permitted for that purpose.

WARNING



- Comply with the laws and regulations in each country for the disposal of refrigerant and compressor oil.
- The release of refrigerant in to the atmosphere is banned by law. Recover it with specific equipment and dispose of it correctly.
- Only people who have sufficient knowledge and experience about the product and its accessories are allowed to recover the refrigerant and compressor oil.

1.7.2 Disposal of product

The disposal of the product must be handled by a specialized industrial waste disposal agency in accordance with local laws and regulations.

1.8 Material Safety Data Sheet (MSDS)

If the material safety data sheets of chemicals used in this product are needed, contact an SMC's sales distributor.

Any chemicals used by the user must be accompanied by an MSDS.

Chapter 2 Name and Function of Parts

2.1 Model Number of Product

The product can be ordered with the model number configured as shown below.

The product needs to be handled in different ways depending on the part number. Refer to "1.4 Product Label" and check the part number of the product.

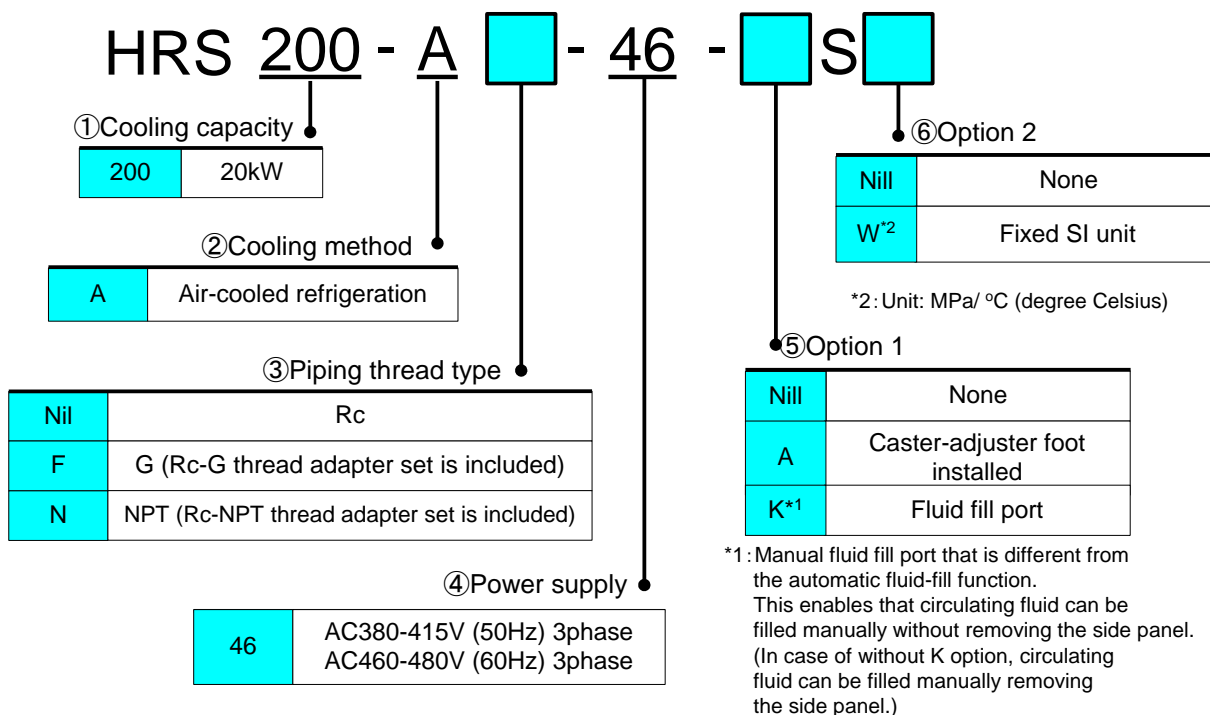

Fig. 2-1 Product model number

2.2 Name and Function of Parts

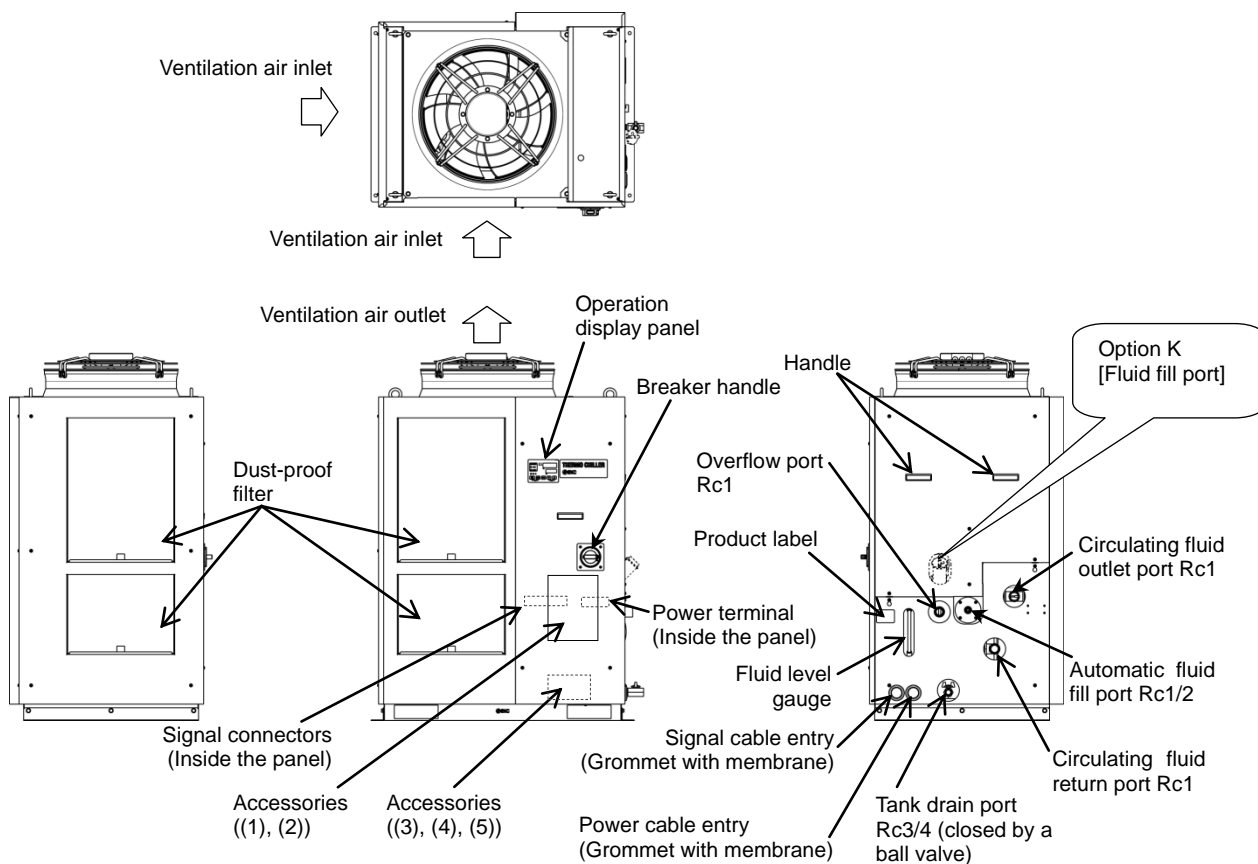



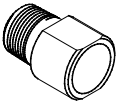

Fig. 2-2 Names of the parts

Table 2-1: Accessory list

(1)	Alarm code list label (English)	1 pc.	
(2)	Operation manual (English)	1 copy	
(3)	Y strainer (40 mesh) 25A	1 pc.	
(4)	Barrel nipple 25A	1 pc.	
(5)	For HRS***-AF-** G thread adapter set (HRS-EP014)	1 set	
	For HRS***-AN-** NPT thread adapter set (HRS-EP013)	1 set	
-	Anchor brackets (M8 bolts)	2 pcs. (6 pcs.)	---

Note) The anchor brackets (including M8 bolts) are used for fixation with the skid when this product is packed.
The anchor bolts are not attached.

2.3 Function of Parts

The function of parts is as follows.

Table 2-2: Function of parts

Name	Function
Operation display panel	Runs and stops the product and performs settings such as the circulating fluid temperature. For details, refer to "2.4 Operation Display Panel".
Fluid level gauge	Indicates the circulating fluid level of the tank. Confirm the level is between HIGH and LOW. For details, refer to "3.5 Circulating Fluid Supply".
Product label	Shows the product information such as model number and serial number. For details, refer to "1.4 Product Label".
Circulating fluid outlet port	The circulating fluid flows out from the outlet port.
Circulating fluid return port	The circulating fluid returns to the return port.
Tank drain port	This drain port to drain the circulating fluid out of the tank.
Automatic water fill port	Piping to the automatic water filling port enables easy supply of the circulating fluid through the ball tap in the reservoir. The supply pressure should be within the range of 0.2 to 0.5 MPa.
Overflow port	Be sure to connect piping from this port to sump pit to discharge the excess circulating fluid that is caused by fluid level rising.
Dust-proof filter	Inserted to prevent that the dust and contamination are clung on the air cooled condensers directly. Clean the filter periodically. For details, refer to "7.2.2 Monthly check".
Power cable entry	Insert the power cable to the power cable entry and connect it to the power terminal. For details, refer to "3.3.2 Electrical wiring" and "3.3.3 Preparation and wiring of power supply cable".
Power terminal	
Signal cable entry	Insert the signal cable to the signal cable entry and connect it to the signal connectors. For details, refer to "3.3.4 Contact input/output communication wiring", "3.3.5 Wiring of run/ stop signal input and remote signal input", "3.3.6 Wiring of external switch signal input", "3.3.7 Wiring of contact output signal", "3.3.8 RS-485 communication wiring", "3.3.9 RS-232C communication wiring" or the Operation Manual Communication Function.
Signal connectors	
Earth leakage breaker	Shuts off the power supply to the internal equipment of the product. (Parts energized remained in the product.) Refer to "3.3.2 Electrical wiring" for the earth leakage breaker.
Water fill port (When option K "Water fill port" is selected.)	Users who will not use the automatic water fill function can fill the circulating fluid without removing the panel.

2.4 Operation Display Panel

The operation panel on the front of the product controls the basic operation of the product.

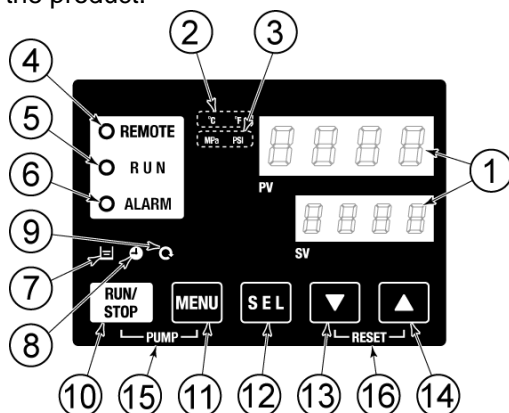



Fig. 2-3 Operation display panel

Table 2-3: Operation display panel

No	Description	Function		Reference page
①	Digital display (7 segment, 4 digits)	PV	Displays the temperature and pressure of the circulating fluid and alarm codes.	5.3
		SV	Displays the set temperature of the circulating fluid and the set values of other menus.	
②	[°C °F] light	Displays the unit of display temperature (°C or °F).		5.13
③	[MPa PSI] light	Displays the unit of display pressure (MPa or PSI).		5.14
④	[REMOTE] light	Turns ON during remote operation by communication.		5.21
⑤	[RUN] light	<ul style="list-style-type: none"> • Turns ON when the product is started and in operation. Turns OFF when the product stops. • Blinks during stand-by for stop (Interval 0.5 seconds). • Blinks during independent operation of the pump (Interval 0.3 seconds). • Blinks while the anti-freezing function is being set (During standby: Interval 2 seconds, During operation: Interval 0.3 seconds). • Blinks during warming up function (During standby: Turns ON for 0.5 seconds and OFF for 3 seconds, During operation: Interval 0.3 seconds.) 		4.4
⑥	[ALARM] light	Blinks with buzzer when alarm occurs (Interval 0.3 seconds).		5.4
		Blinks while AL25 is OFF (Turns ON for 0.5 seconds and OFF for 3 seconds.)		5.20
⑦	[L] light	Turns ON when the fluid level lowers below "L" (low) level.		4.3
⑧	[T] light	Turns ON while the run timer or stop timer function is working.		5.7
⑨	[Q] light	Turns ON when the product is in automatic operation.		5.10
⑩	[RUN/STOP] key	Makes the product start or stop.		4.4
⑪	[MENU] key	Moves from the main menu (display which shows circulating fluid temperature, pressure and etc.) to the other menus (entry of set values and monitor screen).		5.2
⑫	[SEL] key	Changes the item in menu and enters the set value.		
⑬	[▼] key	Decreases the set value.		-
⑭	[▲] key	Increases the set value.		
⑮	[PUMP] key	When the [MENU] and [RUN/STOP] keys are held down simultaneously, the pump starts running independently.		4.3
⑯	[RESET] key	Press the [▼] and [▲] keys simultaneously. This will stop the alarm buzzer and turns OFF the [ALARM] light.		6.3

Chapter 3 Transport and Setting Up

⚠ WARNING



- Only persons who have sufficient knowledge and experience about the product and system are allowed to transport and set up the product.
- Especially pay attention to personal safety.

3.1 Transport

The product is heavy and has potential danger at transport. Also, to prevent damage and breakage of the product, be sure to follow the instructions shown below for transport.

⚠ WARNING



- When moving the product by a forklift, insert the fork into the right positions referring to 3.1.1 Transportation using forklift and hanging- Moving by forklift and slinging should be done by persons who have the licenses.

⚠ WARNING



- Be sure to use all the four eye bolts when slinging the product.
- The slant angle of each rope should be 60 degrees or less.

CAUTION

 Never lay the product on its side.
The compressor oil will leak in to the refrigerant piping, which may cause early failure of the compressor.

CAUTION



- Drain the residual fluid from the piping as much as possible to prevent any spillage.

CAUTION



- When the product is carried by using a forklift, make sure that the fork does not damage the cover panel or piping port.

3.1.1 Transportation using forklift and hanging

⚠ WARNING



This is a heavy product. (Refer to Table 3-1 Weight of the product) Moving by forklift and slinging should be done by persons who have the licenses.

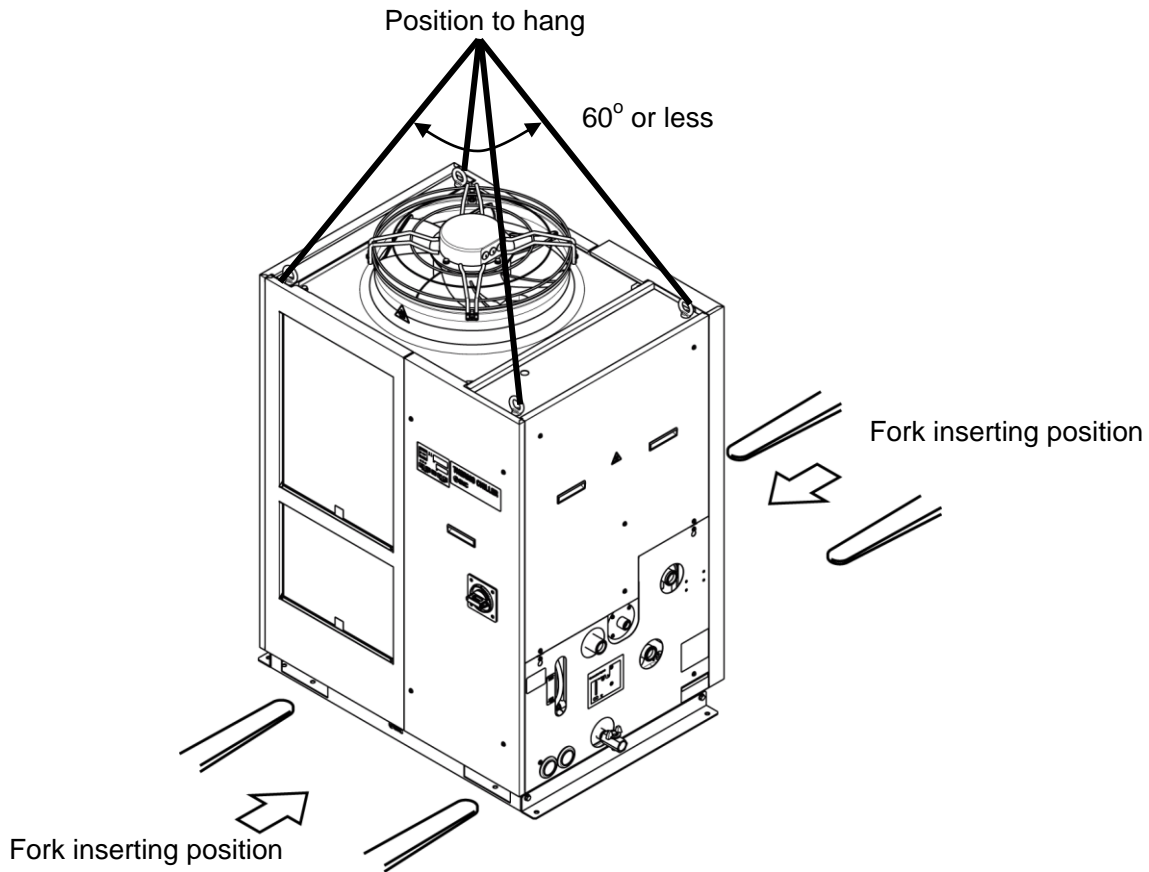

Fig. 3-1 Fork inserting and hanging position

Table 3-1 Weight of the product

Model	Weight kg
HRS200-A*-46-*S*	Approx. 214

3.1.2 Transportation using casters

In case of purchasing option A or the optional accessories, "Caster Adjuster-foot kit" (HRS-KS002) separately and after fastening it to the product.

⚠ WARNING

 **This is a heavy product. (Refer to Table 3-1 Weight of the product). Moving the product by casters should be done by 2 persons or more.**

CAUTION

 **Raise the adjuster feet and push the corners of the product when moving the product using the casters. Do not hold the piping connections or handles of the panels when moving by casters, or it may cause damage to the product..**

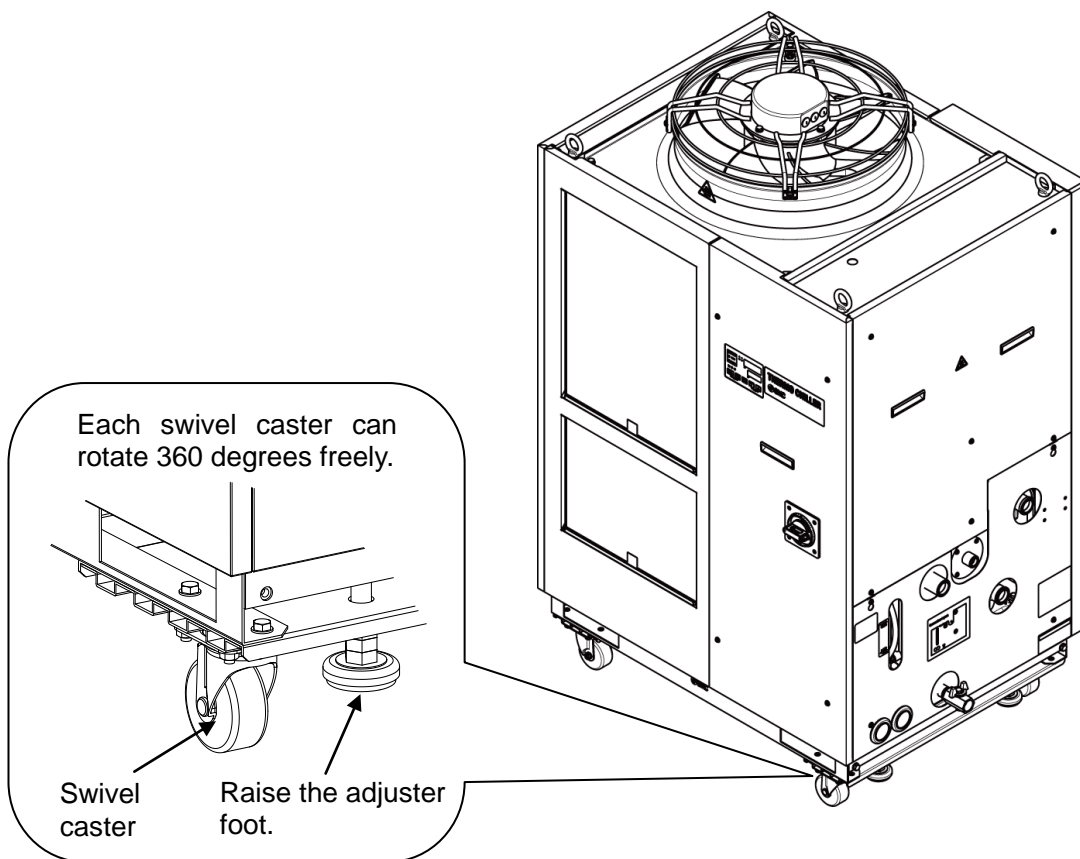

Fig. 3-2 Transportation using casters

3.2 Installation

⚠ WARNING



- Do not set up the product in places possibly exposed to leakage of flammable gas. Should any flammable gas stay around the product, the product may cause a fire.

⚠ CAUTION



- Keep the product upright on a rigid and flat floor which can resist the weight of the product, and take measures to prevent the product from tipping over. Improper installation may cause water leakage, tipping, damage of the product or injure the operator.
- Keep the ambient temperature of the product between -5 to 45°C. Operation out of this ambient temperature range may cause a malfunction of the product. Operating the product in an environment temperature above 45 °C may reduce the heat discharging efficiency of the heat exchanger and the safety device may function, resulting in the product operation stoppage.
- The installer/end user is responsible for carrying out an acoustic noise risk assessment on the equipment after installation and taking appropriate measures as required.

3.2.1 Environment

The product must not be operated, installed, stored or transported in the following conditions. Potential malfunction or damage to the product may occur if these instructions are disregarded.

This product is not designed for clean room usage. The pump and ventilating fan inside the product generate particles.

- Location that is exposed to steam, salt water or oil.
- Location that is exposed to dust or powder material.
- Location that is exposed to corrosive gas, organic solvent, chemical solution, or flammable gas. (The product is not explosion-proof.)
- Location where the ambient temperature is out of the following range:
During transportation or storage: -15 to 50°C (No water or circulating fluid in the piping.)
During operation : -5 to 45°C

* When the ambient temperature or circulating fluid temperature is 10°C or below, use the circulating fluid specified in "3.2.2 Operation at low ambient temperature or low circulating fluid temperature".

- Location where condensation forms on the inside electrical parts.
- Location that is exposed to direct sunlight or heat radiation.
- Location that is near heat sources and poor in ventilation.
- Location that is subjected to abrupt changes in temperature.
- Location that is subjected to strong electromagnetic noise (intense electric field, intense magnetic field, or surges).
- Location that is subjected to static electricity, or conditions where static electricity can discharge to the product.
- Location that is subjected to strong high frequencies radiation.
- Location that is subjected to potential lightning strike.
- Location at altitude of 3000m or higher (except during product storage and transport). Refer to below for details.
- Location where the product is affected by strong vibrations or impacts.
- Condition that applies external force or weight causing the product to be damaged.

- Location without adequate space for maintenance as required.
- Location that is exposed to splash of water that is higher than IPX4.
- For the product installation or operation in accordance with UL standards, see below.

■ Thermo-chiller installation in high altitude of 1000 meters or more

Because of lower air density, the heat radiation efficiencies of the devices in the product will be lower in the location at altitude of 1000m or higher. For this reason, the maximum ambient temperature for the thermo-chiller operation and the cooling capacity will be reduced.

For product installation at a place of high altitude of 1000 meters or more, select a thermo-chiller of the applicable capacity referring to the table below.

1. Max. ambient temp.: Use the product in lower ambient temperature than the described value at each altitude.
2. Cooling capacity correction coefficient: Coefficient to calculate the cooling capacity at each altitude

For the product operation at an altitude of 1800 meters, the cooling capacity at an altitude of 1800 meters = "8.4 Cooling capacity" x 0.8.

Altitude [m]	1. Max. ambient temp. [°C]	2. Cooling capacity correction coefficient
Less than 1000m	45	1.00
1000 m or more - Less than 1500 m	42	0.85
1500m or more - Less than 2000m	38	0.80
2000m or more - Less than 2500m	35	0.75
2500m or more - Less than 3000m	32	0.70

■ Installation/Operation in accordance with the UL standard

For the product operation in UL compliant conditions, use the product in the environment shown below:

- Environment at an ambient temperature of 40°C or less
- Environment at an altitude of 2000 meters or less
- Environment at a pollution degree of 2 or less
- Location where the ambient humidity is within the following range:
During transportation or storage: 15% to 85% (No condensation)
During operation: 30% to 70% (No condensation)

3.2.2 Operation at low ambient temperature or low circulating fluid temperature

(1) Circulating fluid

In order to avoid freezing of the circulating fluid, use aqueous solution of ethylene glycol.

Ambient temperature (°C)	Recommended circulating fluids
10 to 45	Tap water, ethylene glycol aqueous solution 15(wt)%
-5 to 10	Ethylene glycol aqueous solution 15(wt)%

Circulating fluid temperature(°C)	Recommended circulating fluids
10 to 35	Tap water, ethylene glycol aqueous solution 15(wt)%
5 to 10	Ethylene glycol aqueous solution 15(wt)%

(2) And following instructions must be executed. If following instructions are not executed, not only Thermo-chiller alarm will be generated, but also damage of the product can result.

- Power has to be supplied to the Thermo-chiller all the time.
- Turn on anti-freezing function (set parameter: SE.10) all the time.
- When the power supply to the Thermo-chiller is stopped for a long period of time, discharge all the circulating fluid in the Thermo-chiller and customer's device and piping. When the Thermo-chiller is refilled with the circulating fluid, supply the fluid at normal temperature.

3.2.3 Location

CAUTION	
	<ul style="list-style-type: none"> ● Do not install in a location which can be subjected to any of the conditions in “3.2.1 Environment”.

CAUTION	
	<p>The air cooled product radiates heat from the air vent of the cooling fan. If the product is operated with insufficient air ventilation the internal temperature can exceed 45°C, which can cause and affect the performance and life of the product. To prevent this ensure that suitable ventilation is available (see below).</p>

■ **Installation of multiple products**

Keep sufficient space between products so that the air vented from one product will not be taken in by other products.

■ **Installation at indoor site**

1. For a facility having a large installation area (that can vent the air naturally):

Make an air outlet on a wall at a high level and air inlet on a wall at a low level, to allow for adequate airflow.

2. For a facility having a small installation area (that can not vent the air naturally):

Make a forced air exhaust vent on a wall at a high level and an air inlet on a wall at a low level.

3. Using duct to exhaust the air:

In case the indoor site cannot accept the exhausted air from the product or/and is air conditioned, ventilate by installing a duct on the outlet ventilation of the product. Do not fasten the duct on the outlet ventilation of the product directly. Have the space at least the duct’s diameter apart. Use a fan for the duct that considered the ventilation resistance of the duct.

Table 3-2 Amount of radiation and required ventilation

Model	Heat radiation (kW)	Required ventilation amount (m3/min)	
		Differential temp. of 3 °C between inside and outside of installation area	Differential temp. of 6 °C between inside and outside of installation area
HRS200-A*-46-*S*	Approx.37	615	310

■ **Installation at indoor site**

The product’s splash-proof specification is IPX4.

■ **Installation environment specifications**

Sound noise: 75dB(A)

* Front 1m, height 1m, rated condition

3.2.4 Installation and maintenance space

It is recommended to keep the space around the product shown in Fig. 3-3.

⚠ CAUTION

! Have an enough space for the ventilation for the product. Otherwise it may cause a lack of cooling capacity or/and stoppage of the product. Ensure there is enough space for maintenance.

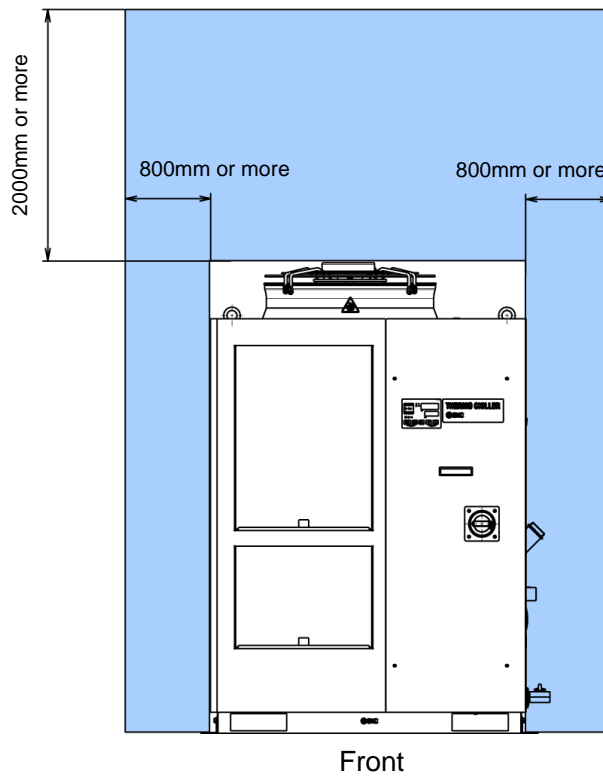
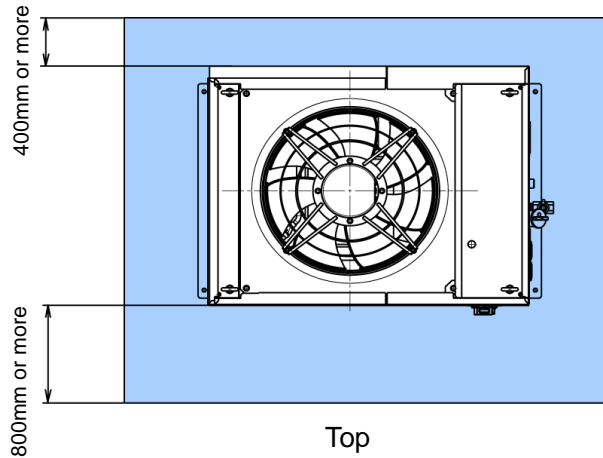

Fig. 3-3 Installation space

3.3 Installation

3.3.1 Installation

⚠ CAUTION



Install the product on a vibration free level floor.
Prepare the M10 anchor bolts that are suitable for the material of the floor that the product will be installed on. Drive the anchor bolts in at least two places on the left and right sides of the product (four places in total). Refer to “8.2 Dimensions” for the dimensions for the position of the anchor bolts.

■ How to mount the product

1. Insert the product to the anchor bolts that were previously driven on the level floor.
2. Fasten the nuts to the anchor bolts.
3. Make sure that there is no looseness on all the anchor bolts and nuts.

Tips

SMC Foundations bolt set “IDF-AB500” (SUS M10x50mm) is applicable.
Please order separately.

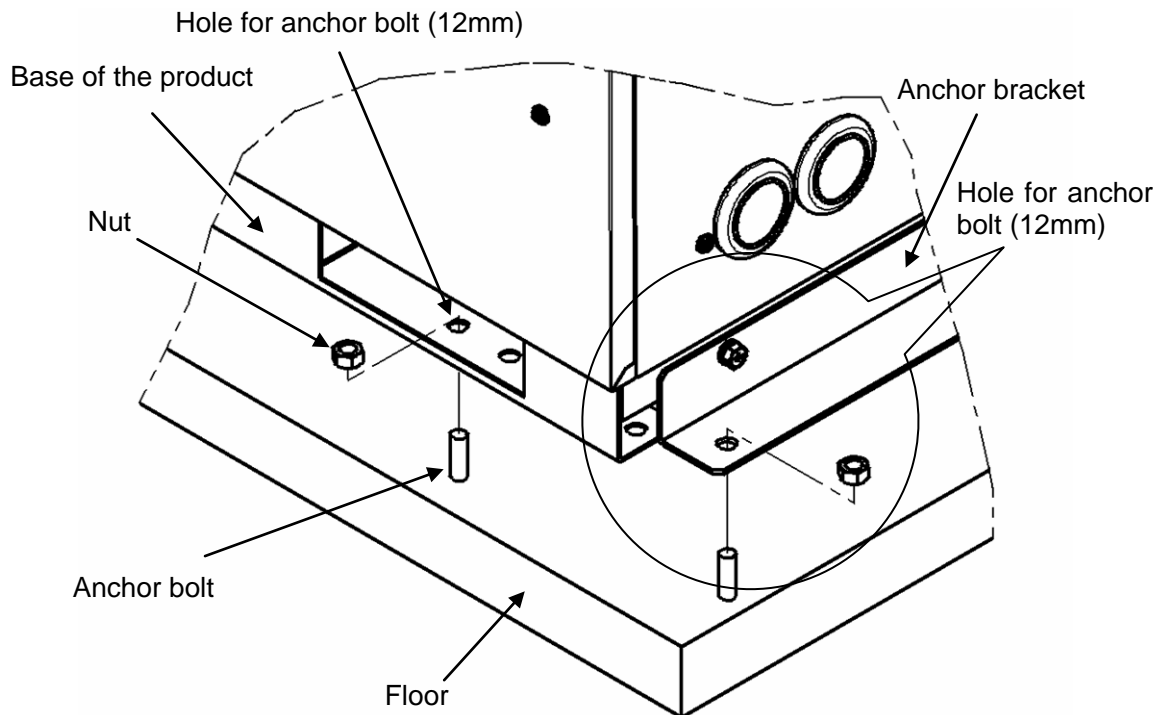

Fig. 3-4 Installation procedures

■ Option A or “Caster Adjuster-foot kit” (HRS-KS002)

⚠ CAUTION



In case of using “Caster Adjuster-foot kit”, be sure to use the adjuster foot to install on the floor. The adjuster foot is not earthquake-proof. If necessary make an earthquake-resistant measure on the customer side.

Refer to the Operation Manual for the separately sold accessory for the further details of the swivel caster and the adjuster foot set.

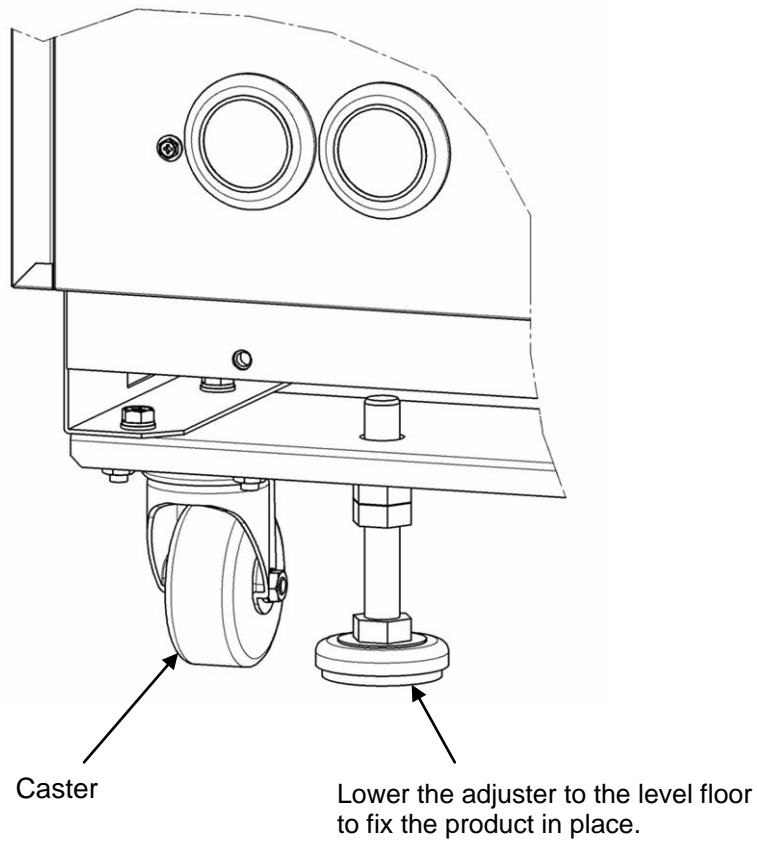



Fig. 3-5 Installation by adjuster foot

3.3.2 Electrical wiring

⚠ WARNING



- Do not modify the internal electrical wiring of the product. Incorrect wiring may cause electric shock or fire. Also, modifying the internal wiring will void the product's warranty.
- NEVER connect the ground to water line, gas pipe or lightning conductor.

⚠ WARNING



- The installation of electrical equipment and wiring work should be performed only by personnel with sufficient knowledge and experience.
- Be sure to shut off the user's power supply. Wiring with the product energized is strictly prohibited.
- The wiring must be conducted using cables complying with "Table 3-3" and firmly secured to the product to prevent the external force of cables being applied to the terminals. Incomplete wiring, or improper securing of wiring, may cause electrical shock or excessive heat and fire.
- Ensure a stable power supply with no voltage surges.
- Ensure that an earth leakage breaker is used in the power supply of the product. See "Table 3-3".
- Use a power supply suitable for the specifications of the product. Use a power supply of over voltage category 3 (IEC60664-1)*.
- Be sure to connect the ground connection.
- Ensure that a lock out facility is available on the power supply.
- Each product must have its own separate earth leakage breaker. Otherwise there can be a risk of electric shock or fire.
- Ensure that no harmonics are superimposed at power supply. (Do not use inverter, etc.)
- Supply a steady power supply which is not affected by surges or distortion. In particular, if the voltage rate of increase (dv/dt) at zero crossing exceeds 40V/200µsec, it may cause malfunction.

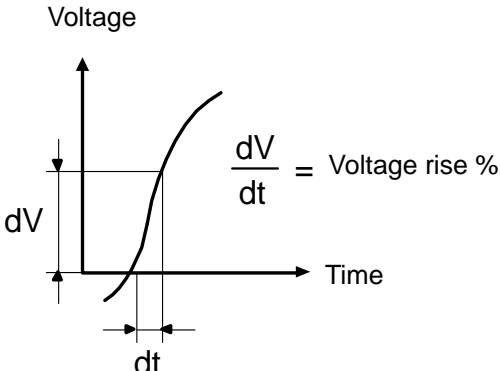

$\frac{dV}{dt} = \text{Voltage rise \%}$

* For the product operation in the UL compliant conditions, refer to "Installation/Operation in accordance with the UL standard" in the next page.

■ Power supply specifications, power supply cable and earth leakage breaker

Prepare the power supply shown in the following table. For the connection between the product and power supply, use the power supply cable and earth leakage breaker shown below. An earth leakage breaker must be mounted to a position where the breaker is easily accessible and close to the thermo-chiller.

Table 3-3 Power supply cable and earth leakage breaker (Recommended)

Model	Power supply voltage	Terminal block screw diameter	Recommended crimp terminal	Cable specifications ^{*2}	Earth leakage breaker ^{*1}	
					Rated current (A)	Sensitivity of leakage current (mA)
HRS200-A*-46-*S	380-415 VAC 50Hz 3 phase, 460-480 VAC 60Hz 3 phase	M5	R5.5-5	4 x 5.5 mm ² (4 x AWG10) *Including ground	30	30

- *1. A specified earth leakage breaker and handle are installed for the product.
- *2. Cable specifications are the examples when using the product at a continuous allowable operating temperature of 70 °C, with an operating voltage of 600 V and two kinds of plastic insulated wires at an ambient temperature of 30 °C. Please select the proper size cables according to the actual condition.

■ Installation/operation in accordance with the UL standard

For the product operation in the UL compliant conditions, the conditions shown below must be satisfied:

- Use power supply of overvoltage category 2^{*1}.
- For power supply cable, it is to be properly prepared by the customer in accordance with National Electrical Code and Canadian Electrical Code.
- Bending radius of the power supply cable must be 38.1 mm or more.

- *1. When using a power supply in the overvoltage category 3, take measures such as mounting an isolation transformer between the product and the power supply or keep the transient overvoltage of the power supply to 2200 V or less by using a varistor, etc.

3.3.3 Preparation and wiring of power supply cable

WARNING



- The electrical facilities should be installed and wired in accordance with local laws and regulations of each country and by a person who has knowledge and experience.
- Check the power supply. Operation with voltages, capacities and frequencies other than the specified values can cause fire and electric shock.
- Wire with an applicable cable size and terminal. Forcibly mounting with an unsuitably size cable may result in heat generation or fire.

WARNING



Be sure to lock out and tag out the breaker of the facility power supply (customer power supply facility) before wiring.

WARNING



Be sure to connect the power supply cable from the product side first, and then connect the breaker of the facility power supply (the user's machine power supply).

CAUTION



- When the panel is removed or mounted, be sure to wear protective shoes and gloves to prevent injury with the edge of the panel.

CAUTION

A breaker that has the operating characteristic below is installed. Please use a breaker that has the same or longer operating time as/than this for the customer side (upstream side). If it has a shorter operating time, there is a possibility of accidental breaker trip due to the internal motors' inrush currents of this product.

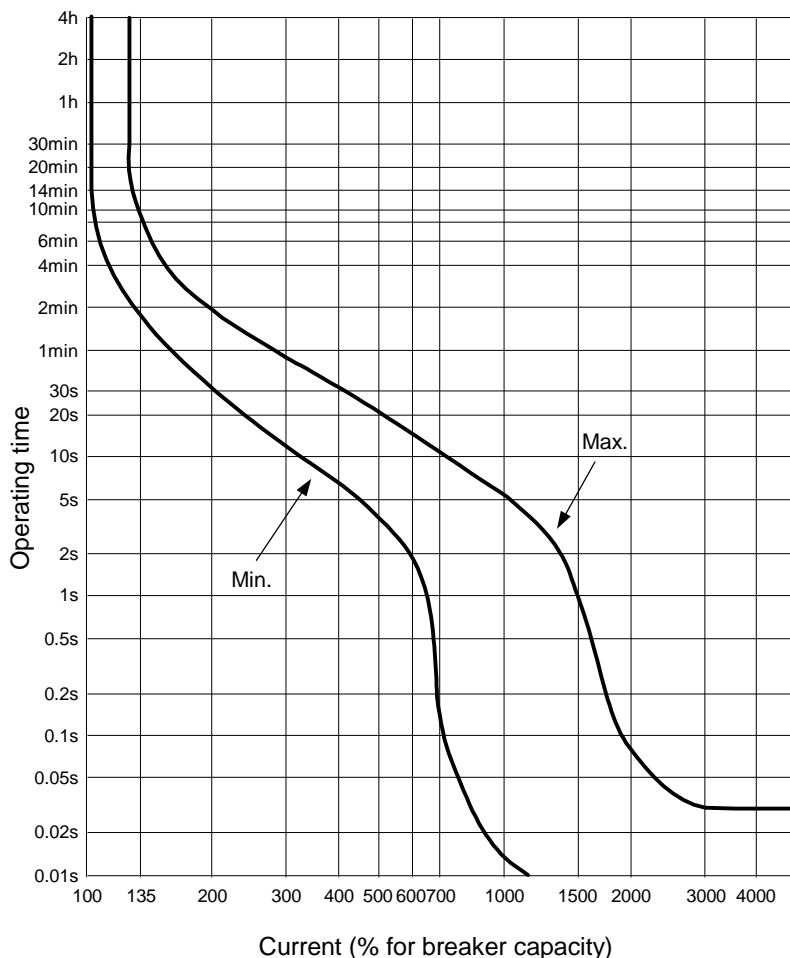

Operating characteristics of the breaker

■ Preparation for operation

1. Remove four screws to remove the front panel for the electrical unit.

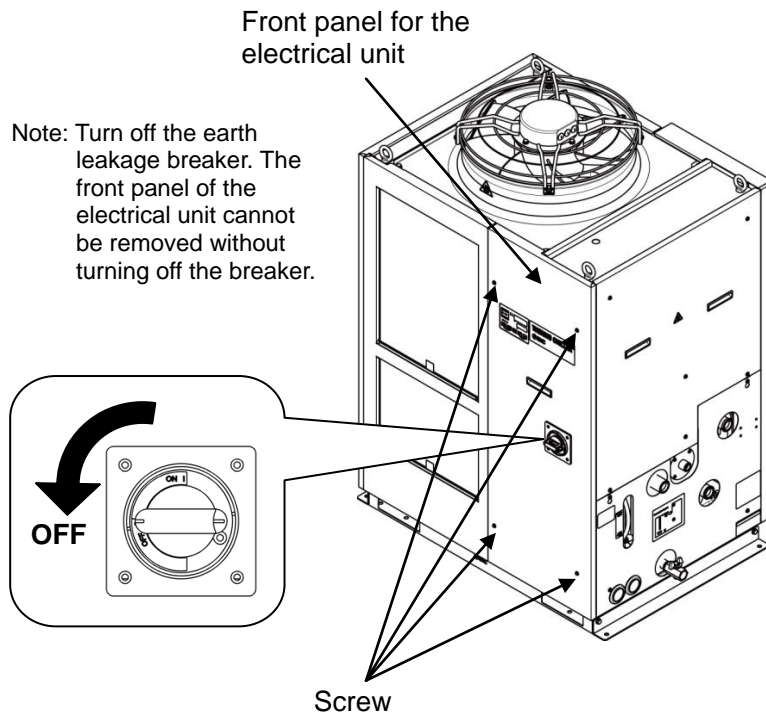

Fig. 3-6 Remove the front panel for the electrical unit

2. Hold the handle and pull up the front panel of the electrical unit, and remove it.

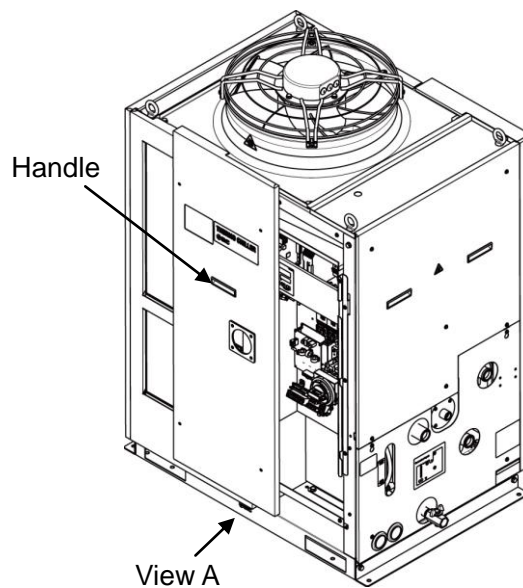

Fig. 3-7 Remove the front panel for the electrical unit

3. Connect the power supply cable and the ground cable as shown in the figure below.

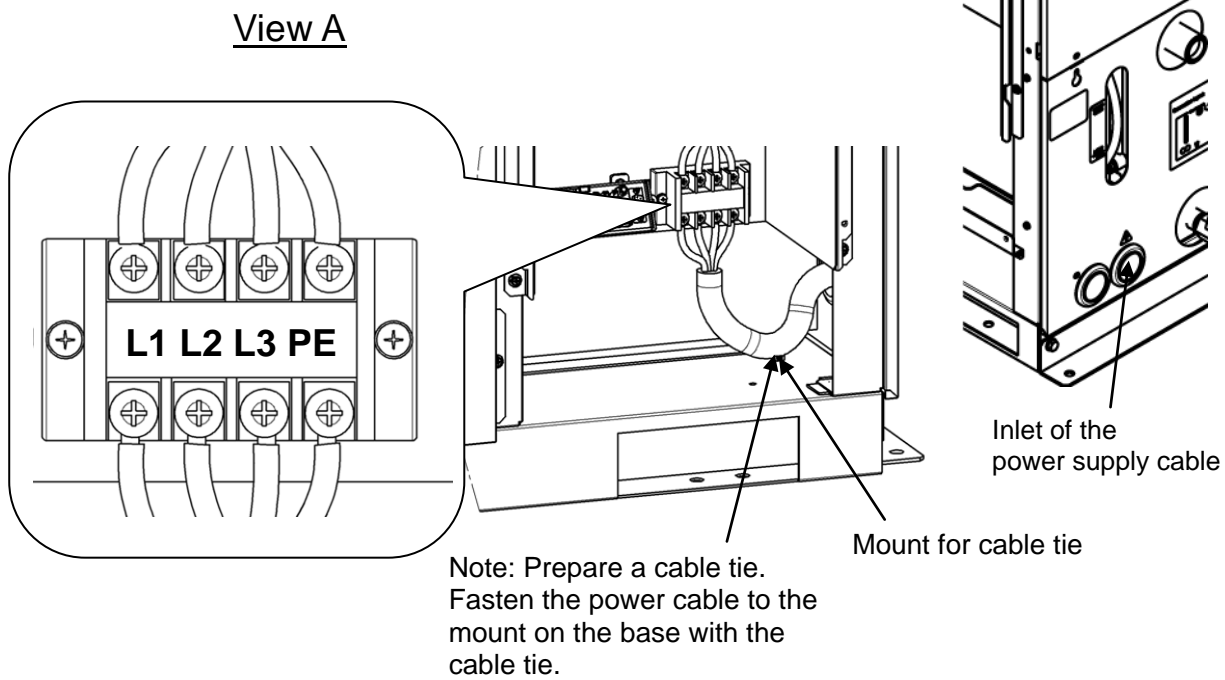

Fig. 3-8 Wiring of power supply cable

- * Connect an over current protection to the power cable connected to the equipment to avoid hazard.
- * For operation of the product in the UL compliant condition, the cable tie must be UL compliant.

3.3.4 Contact input/output communication wiring

⚠ WARNING



Be sure to lock out and tag out the breaker of the facility power supply (the user's machine power supply) before wiring.

CAUTION

Use the cable and terminal that are specified.

The capacity of the output contact of the product is limited. If the capacity is not large enough, install a relay, etc. (to allow for larger capacity). Also, ensure that the input current of the relay is small enough in relation to the contact capacity of the product.

The product has a contact input/output communication function as shown below. Connect cables referring to the applicable chapter for each function. (For details of the functions, refer to Operation Manual Communication Function.)

- Run/Stop input·Remote signal input (Refer to “3.3.5 Wiring of run/stop signal input and remote signal input”)
- External switch signal input (Refer to “3.3.6 Wiring of external switch signal input”)
- Output of contact output signal (Refer to “3.3.7 Wiring of contact output signal Wiring of contact output signal”)

Use the signal cable described below for wiring of each function.

■ Signal cable

Use the cable and terminals as shown below for wiring of each function.

Table 3-4 Signal cable

Terminal specification		Cable specification
Terminal block screw diameter	Recommended crimp terminal	
M3	Y style crimp terminal 1.25Y-3	0.75 mm ² (AWG18) Shielded cable

3.3.5 Wiring of run/stop signal input and remote signal input

Run/Stop signal input and remote signal input enable the product to operate/stop or switched DIO REMOTE and DIO LOCAL remotely by applying a contact signal input. This chapter illustrates examples of wiring.

Select DIO mode as the communication mode to activate the run/stop signal input and remote signal input after wiring referring to Operation Manual Communication Function.

Tips

This product has two input signals. These can be customized depending on the customer's application.

Table 3-5 Power supply, contact specifications

Name	Terminal No.	Specification	
Power supply output	5, 6, 7 (24 VDC)	24 VDC ±10 % 500 mA MAX ^{*1}	
	13,14, 15 (24 V COM)		
Contact input signal 1	3 (Contact input signal 1)	- Run/Stop signal input - External switch signal input ^{*2}	Switch the input on the operation display panel. Refer to the Operation Manual Communication Function for details.
	11 (Common of contact input signal 1)		
Contact input signal 2	4 (Contact input signal 2)	- Run/Stop signal input	
	12 (Common of contact input signal 2)	- Remote signal input - External switch signal input ^{*2}	

*1: To use the power of the device, the total load current must be 500 mA or less.

If the load is 500 mA or more, the internal fuse will blow to protect the product and the alarm “AL21 DC line fuse cut” will be generated. Refer to Chapter 6 Alarm Notification and Troubleshooting.

*2: Refer to “3.3.6 Wiring of external switch signal input.”

- 1.** Prepare the switch (power supply voltage: 24 VDC, contact capacity: 35 mA or more, minimum load current: 5mA), and a signal cable. (See “Table 3-4 Signal cable”)

2. Connect the signal cable and switch to the terminal as shown below. (This wiring is an example. Refer to Operation Manual Communication Function for more details.)

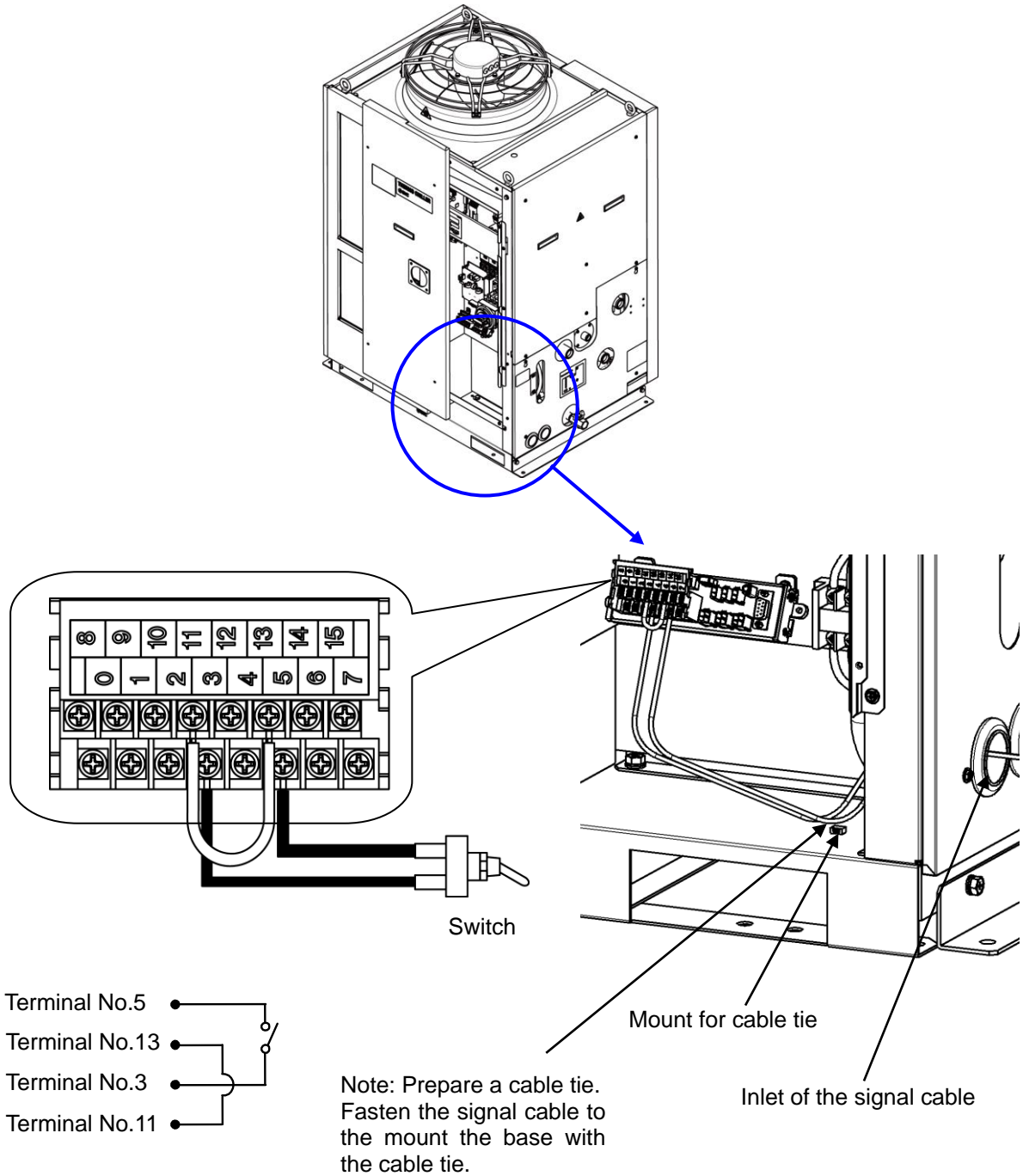

Fig. 3-9 Wiring of run/stop signal input and remote signal input (Example)

3.3.6 Wiring of external switch signal input

This product can be monitored by sampling the signal of the external switch prepared by the user.

Table 3-6 Power supply, contact specifications

Name	Terminal No.	Specification
Power supply output	5, 6, 7 (24 VDC)	24 VDC ±10% 500 mA MAX ^{*1}
	13, 14, 15 (24 V COM)	
Contact input signal 1	3 (Contact input signal 1)	NPN open collector output PNP open collector output (Refer to the Operation Manual Communication Function for details)
	11 (Common of contact input signal 1)	
Contact input signal 2	4 (Contact input signal 2)	
	12 (Common of contact input signal 2)	

*1: To use the power of the device, the total load current must be 500 mA or less.
If the load is 500 mA or more, the internal fuse will be cut to protect the product and the alarm [AL21 DC line fuse cut] will be generated. Refer to Chapter 6 Alarm Notification and Troubleshooting.

One external switch can be connected to contact input signal 1 and one to contact input signal 2 (two in total). The external switch cannot be connected to the contact input signal 1 depending on the communication mode.

Table 3-7 External switch settings

Communication mode ^{*1}		Contact input signal 1	Contact input signal 2
Local mode		✓	✓
SERIAL mode	MODBUS	✓	✓
	Simple communication protocol 1	✓	✓
	Simple communication protocol 2	X	✓
DIO mode ^{*2}		✓	X
		X	✓

*1: Refer to the Operation Manual Communication Function for more details of each mode.
Local mode: Mode allowing the product to be operated by the operation panel. (Default setting)
SERIAL mode: Mode allowing the product to be operated by serial communication.
DIO mode: Mode allowing the product to be operated by the contact input/output communication.

*2: In DIO mode, it is necessary to allocate the operation stop signal to contact input signal 1 or 2. Therefore, only one external switch can be set.

■ Example of connection

As an example of connection of an external switch, the connecting method is shown below using the SMC flow switch (NPN, PNP).
This chapter illustrates examples of wiring.

⚠ WARNING

Be sure to turn OFF the breaker of the facility power supply (the user's machine power supply) before wiring.

Table 3-8 External switches used in the examples

Description	Manufacturer	Part No.	Output type	Current consumption
Flow switch	SMC	PF3W721□-□□-A□(-M)	NPN open collector output	50 mA or less
		PF3W721□-□□-B□(-M)	PNP open collector output	50 mA or less

1. Prepare the flow switch described in the Table 3-8(sold separately).
2. Depending on the external switch output type, connect the wire the switch to the terminals for contact input signal as shown below. (This is an example of wiring. Refer to the Operation Manual Communication Function for further details.)

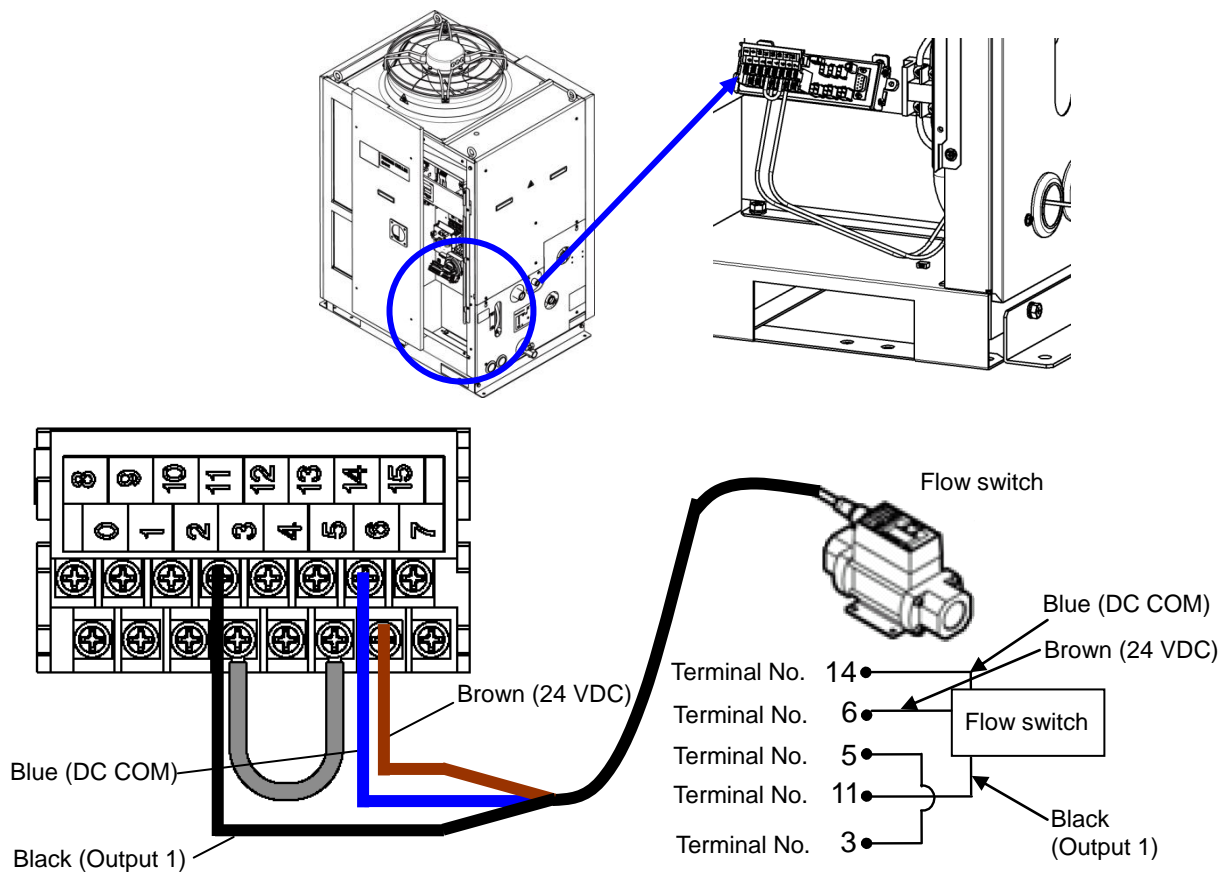

Fig. 3-10 Wiring of the external switch (NPN open collector output) (example)

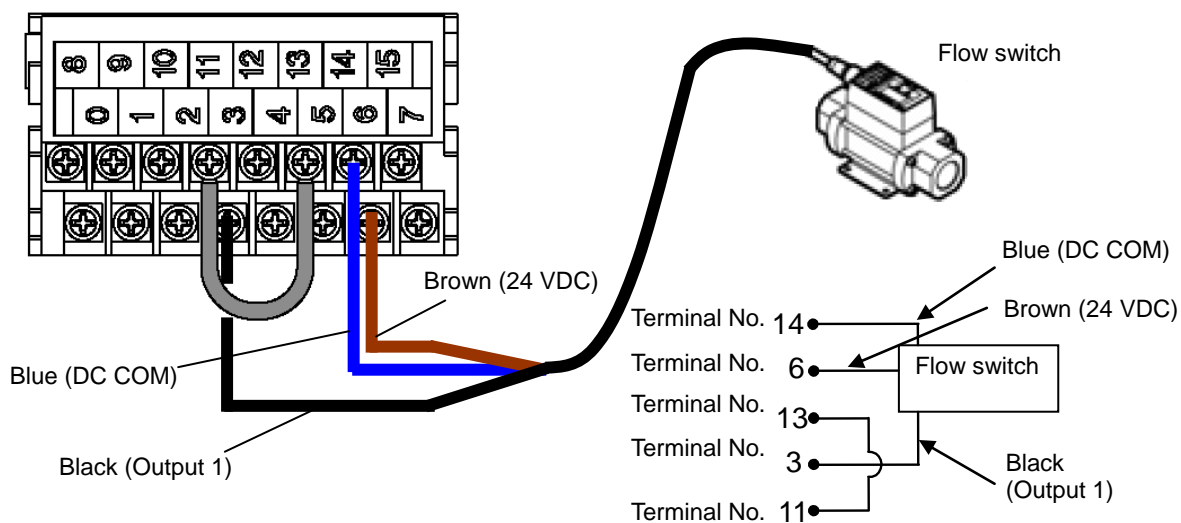

Fig. 3-11 Wiring of the external switch (PNP open collector output) (example)

■ Setting items

Table 3-9 shows the setting items of the external switch. For details, refer to “5.21 Communication Function”.

Table 3-9 Setting list of the external switch

Display	Item	Initial value (Default setting)	Example*	Reference page	Category
[0.01]	Communication mode	LOC	LOC	5.21	Communication setting menu
[0.15]	Contact input signal 1	RUN	SW_A		
[0.16]	Contact input signal 1 type	ALT	ALT		
[0.17]	Contact input signal 1 delay time (time delay) for reading	0	30		
[0.18]	Contact input signal 1 OFF detection timer	0	2		
[0.19]	Contact input signal 2	OFF	OFF		
[0.20]	Contact input signal 2 type	ALT	-		
[0.21]	Contact input signal 2 delay timer (time delay) for reading	0	-		
[0.22]	Contact input signal 2 OFF detection timer	0	-		

* Example: Connect N.O. type flow switch to contact input signal 1 in local mode.

3.3.7 Wiring of contact output signal

Contact output signals are the signals that output the status of this product. Contact specification of each signal output is shown below.

⚠ WARNING	
	Be sure to turn OFF the breaker of the facility power supply (the user's machine power supply) before wiring.

Table 3-10 Signal output contact spec. at the time of shipment

Contact output	Content of the signal (Default setting)	Operation		
Contact output signal 1 (Terminal No: 0, 8)	Operation status signal output	N.O.	During operation:	Contact closed
			During operation stop:	Contact open
			With power supply cutoff:	Contact open
Contact output signal 2 (Terminal No: 1, 9)	Remote status signal output	N.O.	During remote operation:	Contact closed
			During non-remote operation:	Contact open
			With power supply cutoff:	Contact open
Contact output signal 3 (Terminal No: 2, 10)	Alarm status signal output	N.C	While alarm being generated:	Contact open
			While alarm not being generated:	Contact closed
			With power supply shut off:	Contact open

[Tips]

This product has three output signals which can be customized depending on the user's application. Signals shown below can be output. Refer to Operation Manual Communication Function for more details.

- Ready completion (TEMP READY) signal output
- Operation stop alarm signal output
- Operation continuation alarm signal output
- Selected alarm status signal output
- Operation start timer setting status signal output
- Operation stop timer setting status signal output
- Recovery from power failure setting status signal output
- Anti-freezing setting status signal output
- Contact input signal detecting output
- Warming up function setting status output
- Anti-snow coverage function setting status output

3.3.8 RS-485 communication wiring

Serial communication RS-485, operation Start/Stop, setting and reading of circulating fluid temperature, and reading of alarm condition can be performed by remote control.

Refer to Operation Manual Communication Function for more details.

■ Wiring of interface communication cable

⚠ WARNING

Be sure to turn OFF the breaker of the facility power supply (the user's machine power supply) before wiring.

● Connecting to PC

RS-485 cannot be directly connected to a normal PC. Use an RS-232C/RS485 converter which is available on the market.

Be sure to follow the wiring procedure shown below for connecting multiple thermo-chillers.

● Configuration of connection

One thermo-chiller for one host computer, or multiple thermo-chillers for one host computer.
 (31 thermo-chillers can be connected at maximum.)

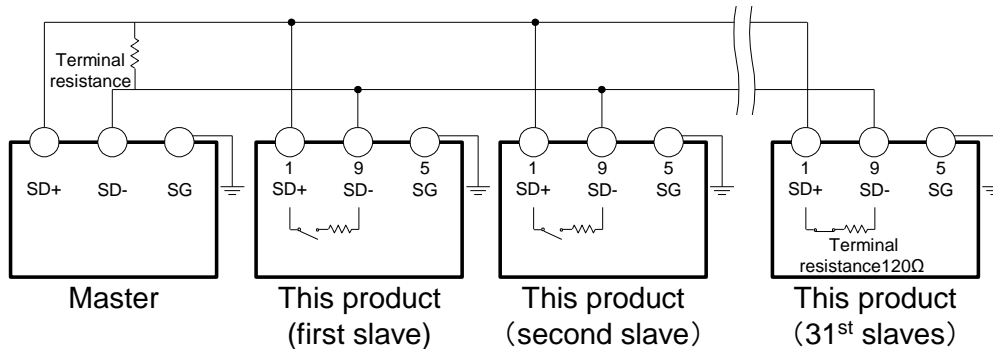

Fig. 3-12 Connection of RS-485

Tips

Both ends of the communication connection (the end nodes) need to be connected to the host computer.

With or without the terminating resistor (120Ω) of this product can be set by the operation display panel. Refer to “5.21 Communication Function”.

3.3.9 RS-232C communication wiring

Serial communication RS-232C, operation start/stop, setting and reading of circulating fluid temperature, and reading of alarm condition can be performed by remote control.

Refer to Operation Manual Communication Function for more details.

■ Wiring of communication cable

⚠ WARNING



Be sure to turn OFF the breaker of the facility power supply (the user's machine power supply) before wiring.

Be sure to wire as shown in the figure below.

● Configuration

One thermo-chiller for one master.

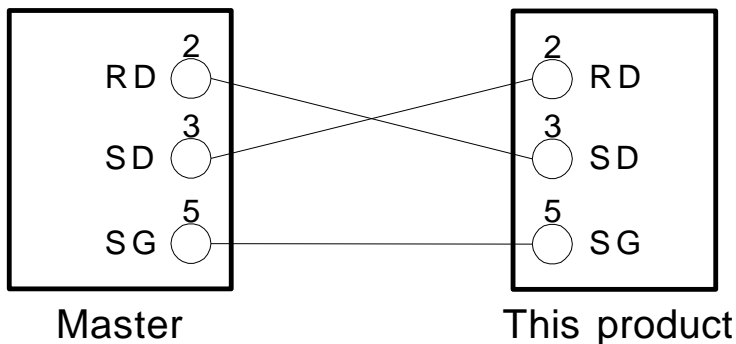



Fig. 3-13 Connection of RS-232C

3.4 Piping

⚠ CAUTION



- Connect piping firmly. Incorrect piping might cause leakage of supplied or drained fluid and wet surrounding area and facility.
- Use caution not to allow dust and foreign matter to enter the water circuit, etc. during connection of piping.
- During piping work, residual liquid may drip from the circulating fluid circuit or facility water circuit. Prepare a drain pan near the pipe connection so that the residual liquid can be received.
- Securely connect the piping at the piping port with specific wrench when tightening.
- Incorrect piping can burst in service.
- Use non-corrosive material for fluid contact parts of circulating fluid. Using the materials that tend to rust or corrode may cause clogging or/and leakages of the circulating fluid circuits. In case of using these kinds of materials, consider and carry out some prevention against the rusting or corrosion by the customer side.
- Do not generate a rapid change of pressure by water hammer, etc. Internal parts of the product and/or the piping may be damaged.
- It is recommended to use heat insulation to reduce the heat radiation and absorption to/from customer's piping.

■ Piping port size

Table 3-11 Piping port size

Description	Port size	Recommended tightening torque	Recommended piping specifications
Circulating fluid outlet port	Rc1	36 to 38Nm	1.0 MPa or more
Circulating fluid return port	Rc1	36 to 38Nm	1.0 MPa or more
Automatic fluid fill port	Rc1/2	20 to 25Nm	1.0 MPa or more (Automatic fluid fill pressure: 0.2 to 0.5 MPa)
Overflow port	Rc1	36 to 38Nm	ID 25 mm or more Length 5m or less
Tank drain port	Rc3/4	28 to 30Nm	ID 19 mm or more

Tips

<For HRS200-AN-46-*S>

A set of thread adapters that converts the connections from Rc to NPT is enclosed as an accessory. For NPT thread, be sure to use this adapter.

<For HRS200-AF-46*S>

A set of thread adapters that converts the connections from Rc to G is enclosed as an accessory. For G thread, be sure to use this adapter.

■ How to connect piping

Hold the each piping port with a wrench and tighten the piping.

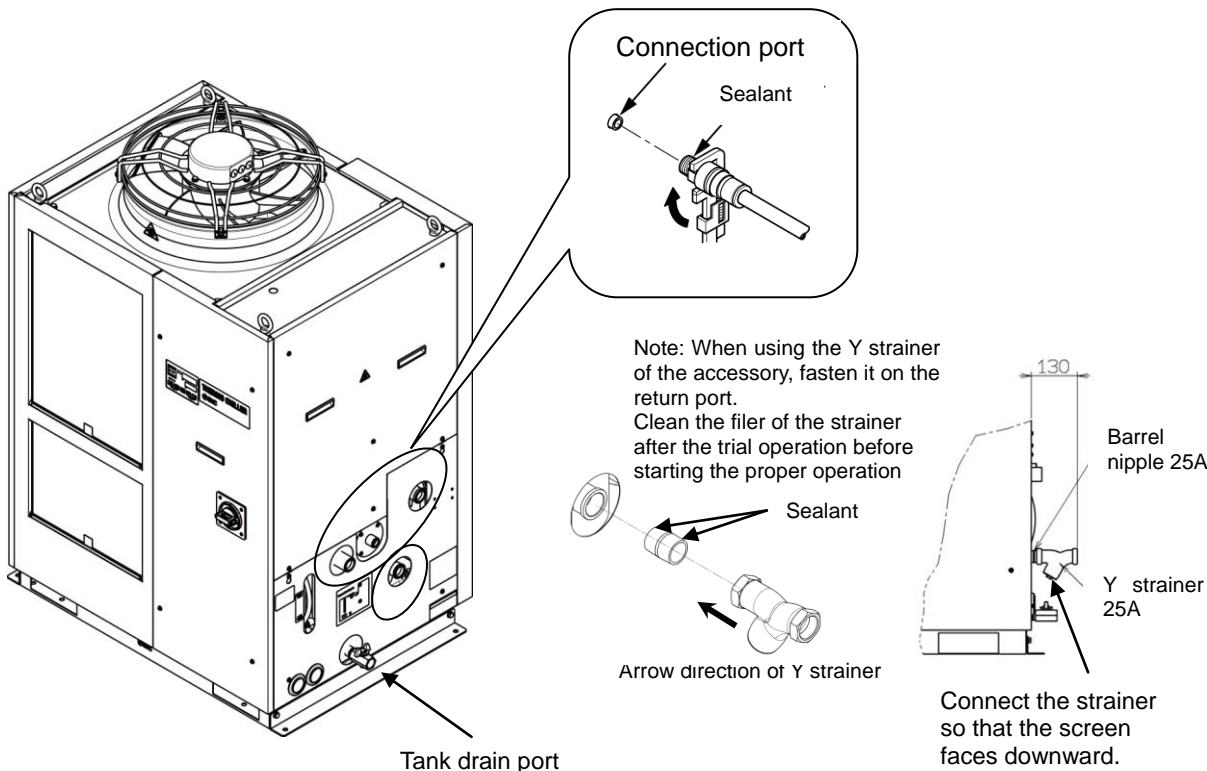

Fig. 3-14 Tightening of piping

■ How to connect to the drain port

When piping the drain port, hold the ball valve of the drain port with a wrench not to rotate it.

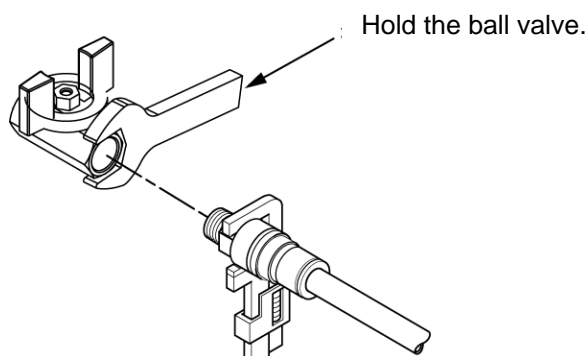

Fig. 3-15 Connection to the drain port

⚠ CAUTION



Without holding the ball valve of the drain port with a wrench, the ball valve may rotate and it may cause a fluid leakage and/or malfunction of the product. Be sure to hold the ball valve of the drain port.

■ Recommended piping circuit

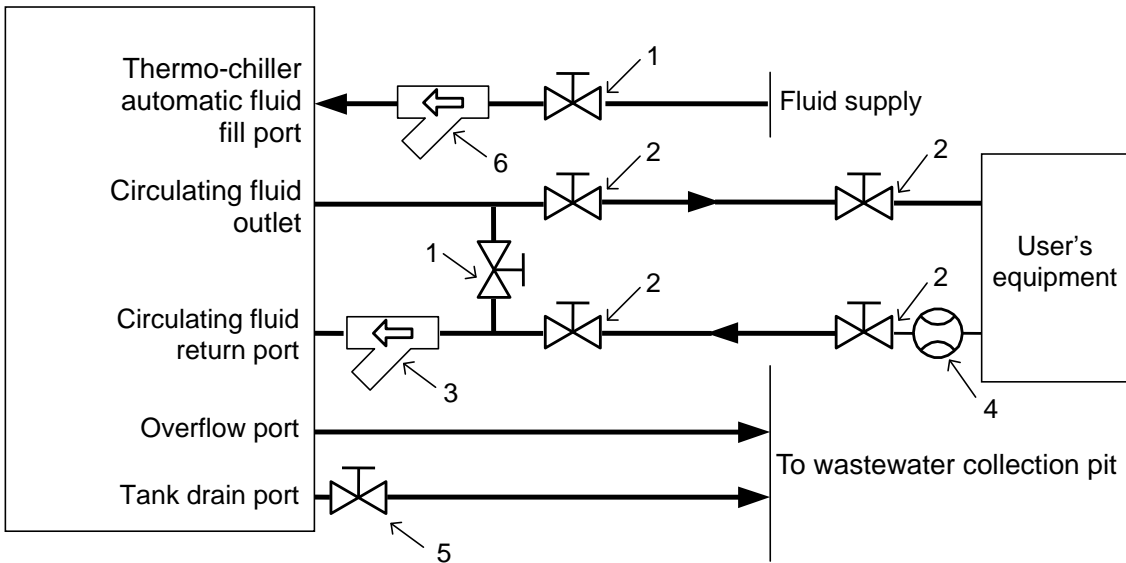

Fig. 3-16 Recommended piping circuit

No.	Description	Size
1	Valve	Rc1/2
2	Valve	Rc1
3	Y-strainer (#40)	Rc1
4	Flow metter	Prepare a flow metter with an appropriate flow range.
5	Valve (Part of thermo-chiller)	Rc3/4
6	Y-strainer (#40)	Rc1/2

3.5 Circulating Fluid Supply

3.5.1 Automatic water fill function

CAUTION



- When clear water is used, refer to "7.1 Quality Control of Circulating Fluid and Facility Water".
- When ethylene glycol aqueous solution is used, dilute pure ethylene glycol with water. Refer to "3.2.2 Operation at low ambient temperature or low circulating fluid temperature" for the concentration of the ethylene glycol aqueous solution. Additives such as antiseptics cannot be used.
- When deionized water is used, the conductivity should be 1 $\mu\text{S}/\text{cm}$ or higher (Electrical resistivity: 1 $\text{M}\Omega\cdot\text{cm}$ or lower).

Open the fluid supply valve that is connected to the automatic water fill port.
Fluid supply starts and stops automatically with the ball tap in the tank.

CAUTION



- Confirm that the fluid level is between "HIGH" and "LOW" level of the fluid level gauge.
- Be sure to connect the piping from the overflow port to the drainage pit to drain excessive amount of the fluid from the tank.

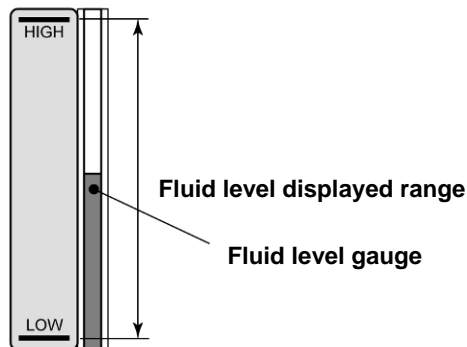

Fig. 3-17 Fluid level gauge

CAUTION



- Confirm that the valve of the drain port is closed to prevent the supplied circulating fluid from draining out.

CAUTION



- When the ambient temperature or circulating fluid temperature is 10°C or below, refer to "3.2.2 Operation at low ambient temperature or low circulating fluid temperature". Tap water may be frozen in the thermo-chiller which may damage the product.

Ethylene glycol aqueous solution

When ethylene glycol aqueous solution is used, prepare the ethylene glycol aqueous solution separately.

Refer to "3.2.2 Operation at low ambient temperature or low circulating fluid temperature" for the concentration of the ethylene glycol aqueous solution.

To control the concentration of the ethylene glycol aqueous solution, a densitometer is available (sold separately) from SMC.

Item	No	Remarks
Ethylene glycol aqueous solution 60%	HRZ-BR001	Dilute to with clean water (tap water).
Densitometer	HRZ-BR002	—

CAUTION



- When using ethylene glycol aqueous solution, check the concentration periodically because the density will be reduced due to the automatic water fill function.

Piping of the overflow

Description	Port size	Specification
Automatic water fill port	Rc1/2	Supply pressure: 0.2 to 0.5 MPa
Overflow port	Rc1	The piping should be $\varnothing 25$ mm or more and the length of 5 meters or less. Avoid riser piping (trapping part).

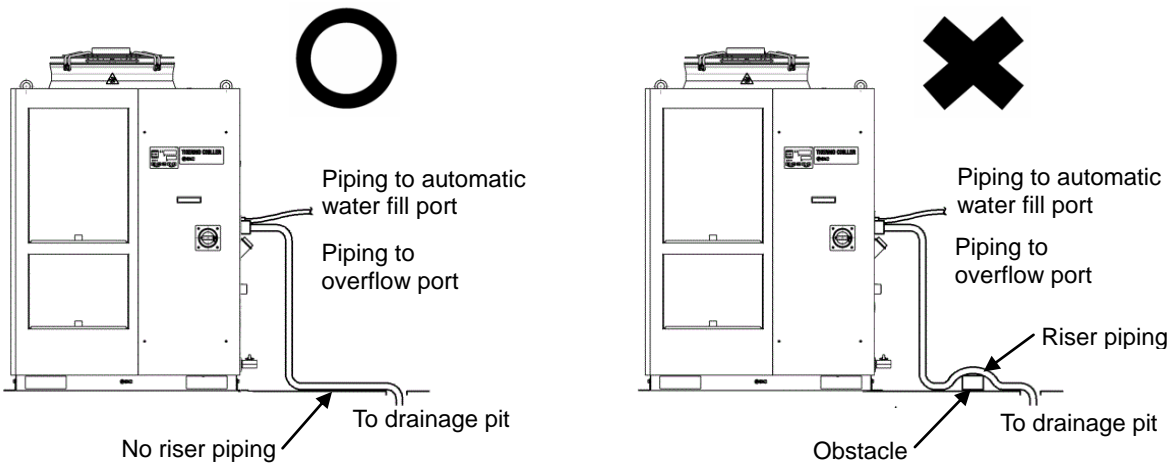



Fig. 3-18 Piping to the automatic water fill port and overflow port

CAUTION



- When using ethylene glycol aqueous solution, collect the overflowed fluid in the recycling pit and dispose it according to the local law of the country and area that the product is installed.

3.5.2 Fluid supply without using the automatic water fill function

To supply the circulating fluid without using automatic water fill function, remove the upper panel on the right side, and supply the fluid to the water fill port on top of the tank.

1. Remove the screws to remove the upper panel on the right side.

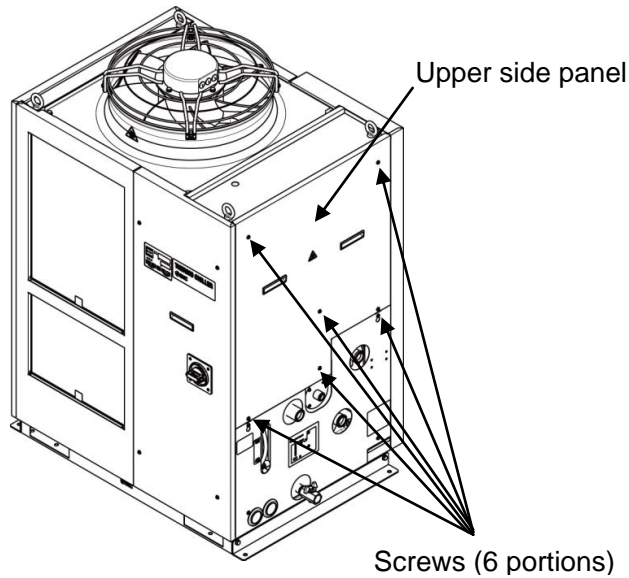

Fig. 3-19 Removal of the right side panel

2. Hold the handles and lift the upper right side panel, and remove it.

Remove the wing nuts (4 portions) on top of the tank and remove the lid also.

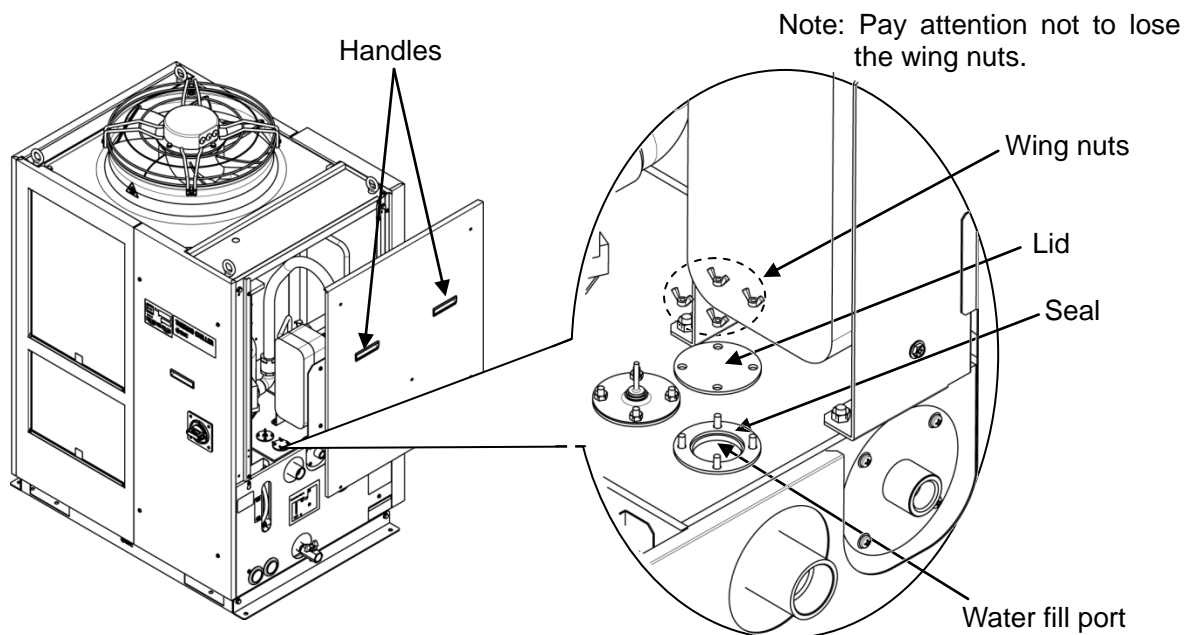

Fig. 3-20 Removal of the right side panel and the lid of the water fill port

3. Supply the circulating fluid to the water fill port.

CAUTION



- Confirm that the fluid level is between “HIGH” and “LOW” levels of the fluid level gauge. If it exceeds the specified level, the circulating fluid will overflow.
- Be sure to connect the piping from the overflow port to the drainage pit to drain the excessive amount of the fluid from the tank.

Please supply the circulating fluid to the fluid level between “HIGH” and “LOW” levels of the fluid level gauge.

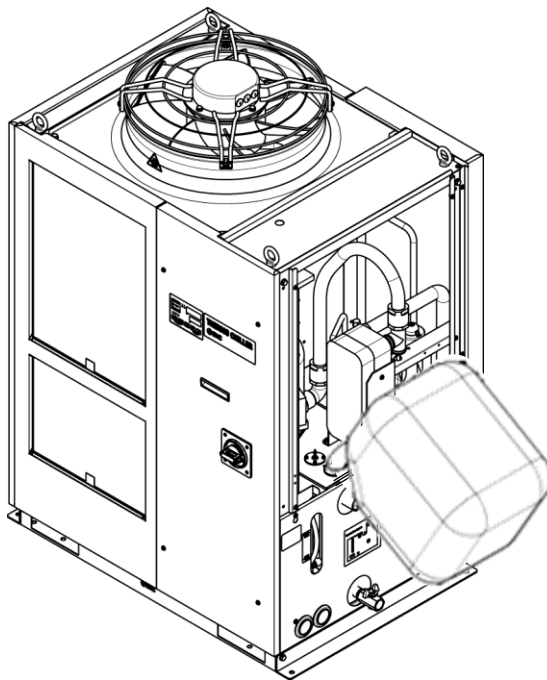

Fig. 3-21 supplying the fluid to the water fill port (An example)

CAUTION



- Confirm that the valve of the drain port is closed to prevent the supplied circulating fluid from draining out.

3.5.3 Option K “Water fill port”

CAUTION



- Confirm that the fluid level is between “HIGH” and “LOW” levels of the fluid level gauge. If it exceeds the specified level, the circulating fluid will overflow.
- Be sure to connect the piping from the overflow port to the drainage pit

Open the cap of the water fill port and supply the circulating fluid to the fluid level between “HIGH” and “LOW” levels of the fluid level gauge.

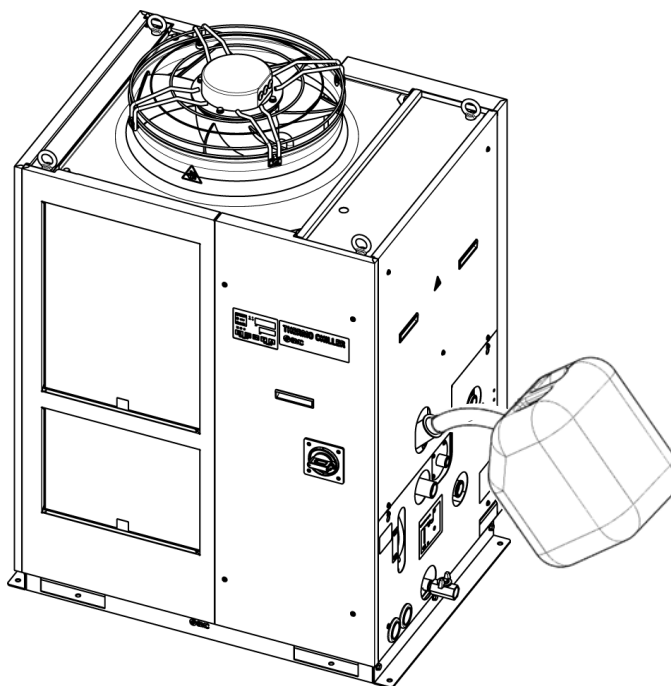



Fig. 3-22 supplying the fluid to the water fill port (An example)

CAUTION



- Comfirm that the valve of the drain port is closed to prevent the supplied circulating fluid from draining out.

Chapter 4 Starting the Product

CAUTION



Only people who have sufficient knowledge and experience about the product and its accessories are allowed to start and stop the product.

4.1 Before Starting

Check the following points before starting the product.

- **Installation state**
 - Check that the product is installed horizontally.
 - Check that there are no heavy objects on the product, and the external piping is not applying excessive force to the product.
- **Connection of cables**
 - Check that the power, ground and I/O signal cables (to be supplied by user) are correctly connected.
- **Circulating fluid piping**
 - Check that the circulating fluid piping is correctly connected to the inlet and outlet.
- **Piping to automatic water fill port**
 - Confirm that the piping to the automatic water fill port is correctly connected.
- **Piping to overflow port**
 - Piping must be connected to the overflow port regardless of using or not using the automatic water fill function.
 - Confirm that the piping to the overflow port is correctly connected.
- **Fluid level gauge**
 - Confirm that the fluid level is between 'HIGH' and 'LOW' levels of the fluid level gauge.

4.2 Preparation for Start

4.2.1 Power supply

Turn ON the breaker of the user's power supply.

When the product is switched ON, the operation panel display operates as shown below:

- The initial screen (HELLO screen) is displayed for 8 seconds on the operation display panel. Then, the display moves to the main display which shows the circulating fluid outlet temperature.
- The set circulating fluid temperature is displayed as SV on the digital display.
- The present circulating fluid temperature is displayed as PV on the digital display.

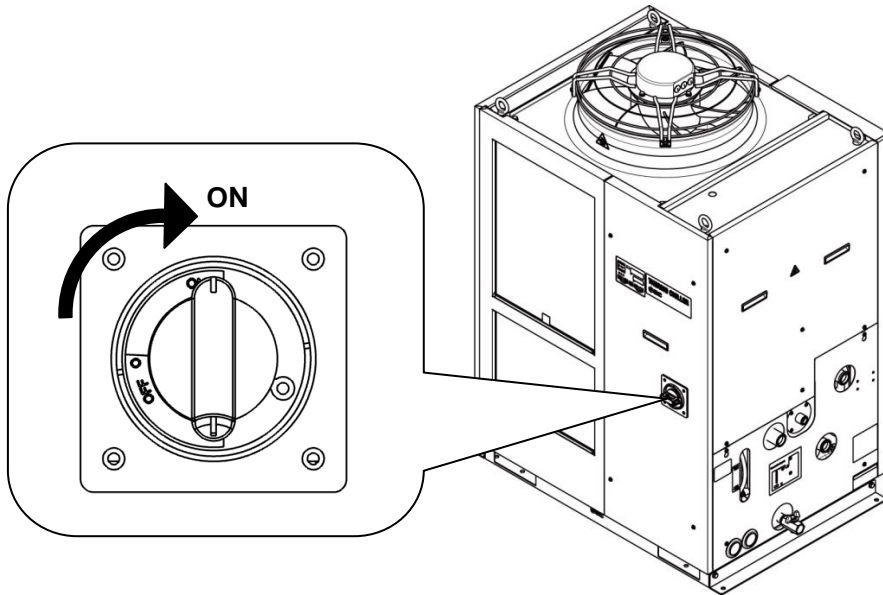

Fig. 4-1 Position of the breaker handle

4.2.2 Setting of circulating fluid temperature

Press the [▼] or [▲] key on the operation panel to change the SV to the required value.

When setting the circulating fluid temperature by communication, refer to Operation Manual Communication Function.

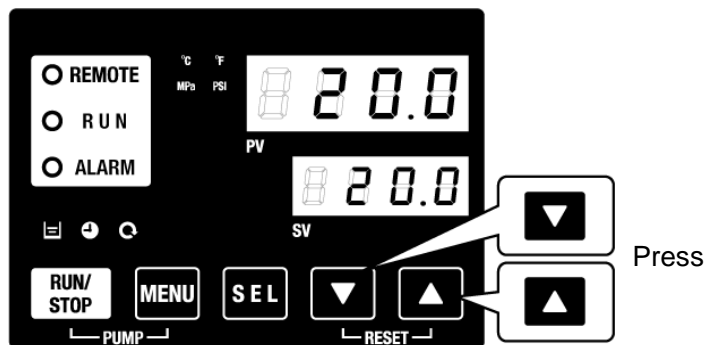

Fig. 4-2 Setting of circulating fluid temperature

4.3 Preparation of Circulating Fluid Supply to User's Equipment

Circulating fluid is supplied only inside of the product at the time of installation of the thermo-chiller.

When the product starts operation in this condition, circulating fluid level will be reduced as the fluid in the level gauge goes down due to the fluid supply to the user's equipment from the thermo-chiller, and the additional fluid needs to be supplied to the thermo-chiller.

Follow the instructions below to supply additional fluid:

1. Press the [PUMP] key on the operation panel (press the [RUN/STOP] key and [MENU] key simultaneously).

The pump operates independently while the [PUMP] key is being pressed. The [RUN] light (green) blinks while the pump is operating independently and the circulating fluid in the tank is supplied to the user's equipment and piping. This finds out leakage from the piping as well as discharges air from the piping. If the fluid level in the tank reaches the lower limit, a buzzer will be generated, and the alarm number "AL01 (low level in tank)" is displayed as PV on the digital display. The [ALARM] light (red) blinks, the [ALARM] light turns ON, and independent operation of the pump stops. For alarm reset, refer to step 2.

CAUTION

When any external fluid leakage is found with the piping during this operation, stop the individual operation of the pump and fix the leaking part.

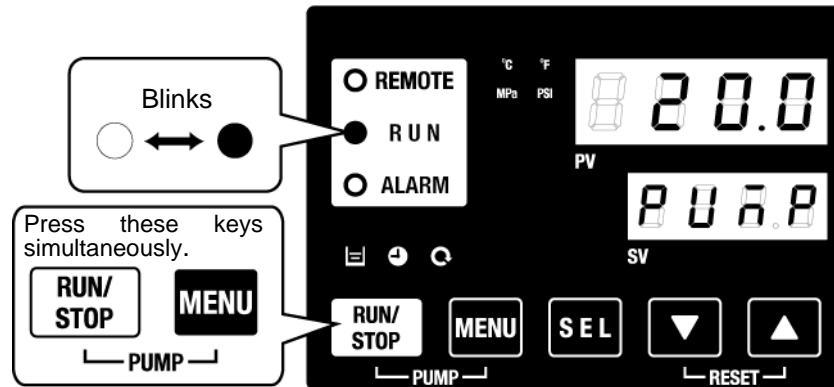

Fig. 4-3 Individual operation of the pump

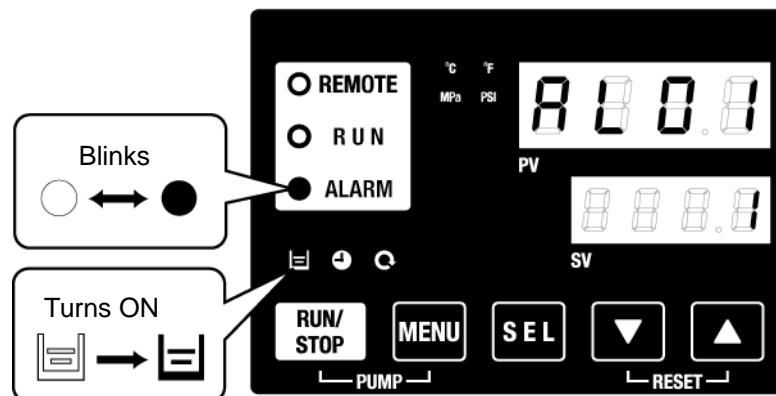

Fig. 4-4 "Low level in tank" alarm

2. Press the [RESET] key (press the [▼] and [▲] keys simultaneously) to stop the alarm buzzer.

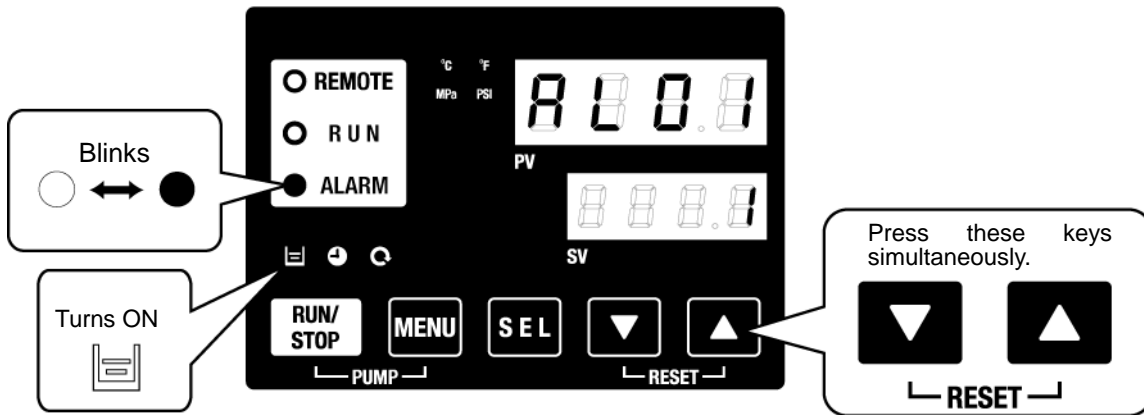

Fig. 4-5 How to stop the alarm buzzer

CAUTION

Reset alarms on the "Alarm menu" screen. Alarm reset is not accepted from any screen except the "Alarm menu" screen. Refer to "5.2.1 Key operations".

3. Fluid supply using automatic water fill function has been started. Operation shown in step 5 can be performed after some minutes.
4. For the product with option K, "with water fill port", supply circulating fluid to the water fill port using a portable polyethylene tank, etc.

5. Press the [RESET] key (press the [▼] and [▲] keys simultaneously) to reset the alarm.

Pressing these keys at the same time resets the alarm (low level in tank) and turns OFF the [ALARM] LED (red) and the [≡] LED. The display returns to the initial main menu screen, "Circulating fluid temp./Circulating fluid set temp.". Press the [PUMP] key (press the [RUN/STOP] key and the [MENU] key simultaneously) again to operate the pump individually.

CAUTION

Reset alarms on the "Alarm menu" screen.
Alarm reset is not accepted from any screen except the "Alarm menu" screen.

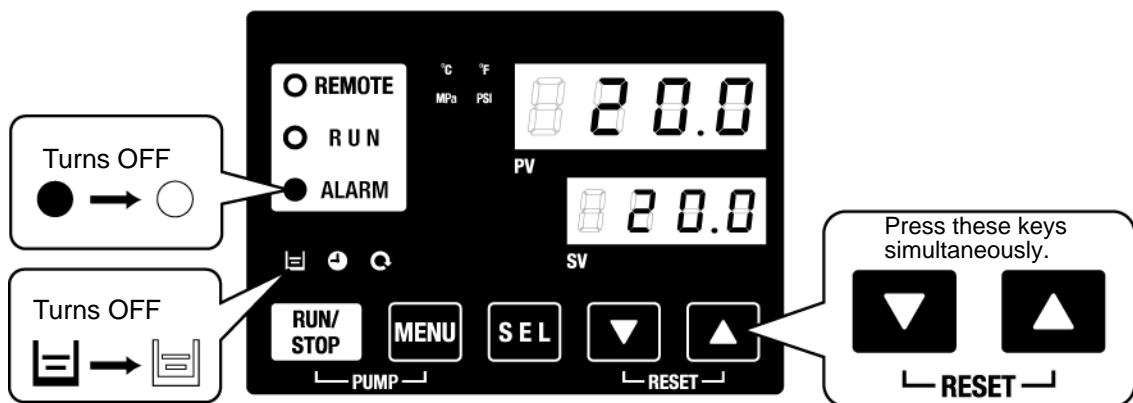

Fig. 4-6 Reset of the alarm

6. Repeat steps 1 to 5 to supply the circulating fluid to the user's equipment and piping. Keep the fluid level in the tank between the "HIGH" and "LOW" levels of the fluid level gauge of this product.

Tips

Please keep the fluid level in the tank between the "HIGH" and "LOW" levels of the fluid level gauge of this product when the pump stopped, too. There is possibility that the circulating fluid drain from the overflow port.

4.4 Operation Start and Stop

4.4.1 Starting the product

CAUTION

 **Allow at least five minutes before restarting the product.**

Before starting, check the items specified in “4.1 Before Starting”

If any alarm light remains ON, refer to “Chapter 6 Alarm Notification and Troubleshooting” and reset the alarm.

1. Press the [RUN/STOP] key on the operation panel.

The [RUN] LED (green) turns ON and the product starts running. The circulating fluid discharge temperature (PV) is controlled to the set temperature (SV).

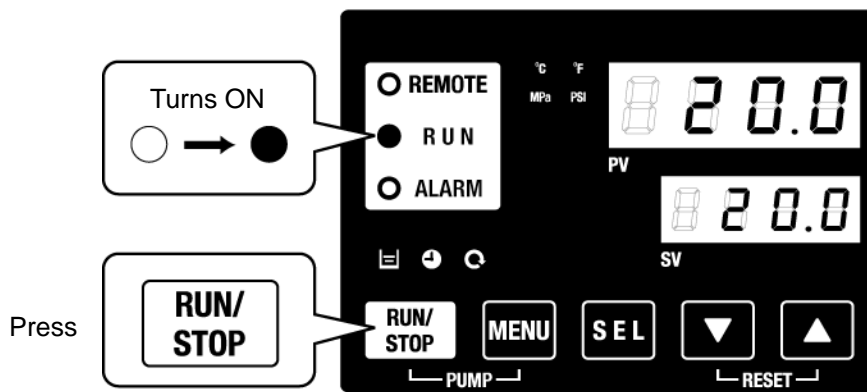

Fig. 4-7 Starting the product

CAUTION

When any alarm is generated, refer to “Chapter 6 Alarm Notification and Troubleshooting”.

2. Be sure to confirm that the circulating fluid level satisfies the minimum required flow rate specified for each model with the check monitor menu.

4.4.2 Stopping the product

1. Press the [RUN/STOP] key on the operation panel.

The [RUN] light on the operation panel blinks green at 1 second intervals, and continues operation to prepare to stop. After approximately 20 seconds, the [RUN] light turns OFF and the operation stops completely.

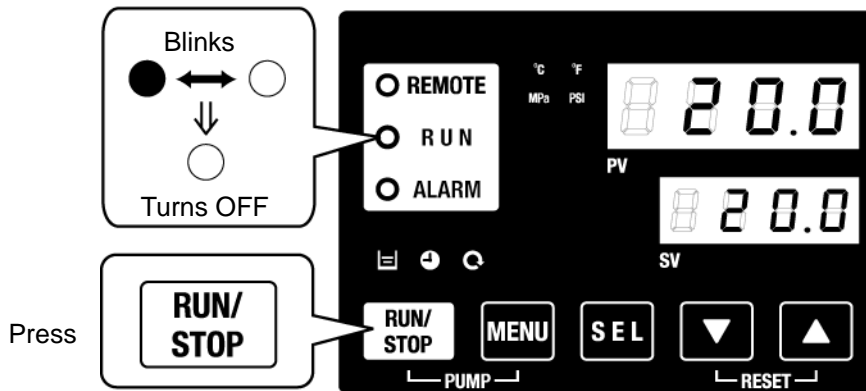

Fig. 4-8 Stopping the product

2. Turn off the earth leakage breaker of the user's power supply.

CAUTION



Except in case of an emergency, do not turn OFF the breaker before the thermo-chiller stops operation completely.

4.5 Check Items during Startup

Check the following items after starting the product.

WARNING



When any abnormality is found, press the [STOP] key to stop the product operation, and then turn OFF the breaker of the user's power supply.

- Confirm that there is leakage from the piping.
- Confirm that no circulating fluid is discharged from the tank drain port.
- Confirm that the circulating fluid pressure is within the specification range.
- Confirm that the fluid level shown by the fluid level gauge is within the specification range.

4.6 Adjustment of Circulating Fluid Flow Rate

When the circulating fluid flow rate is smaller than the minimum required, the product may fail to maintain the performance, making it impossible for the compressor to operate.

Refer to "Fig.3-16 Recommended piping circuit", and adjust the flow rate with the manual valve to the required pressure or flow rate while monitoring the pressure and/or flow rate.

[Tips]

Regarding the minimum required flow rate, refer to "8.1 Specifications".

Chapter 5 Display and Setting of Various Functions

⚠ WARNING



Read and understand this manual carefully before changing the settings.

5.1 List of Functions

The product can have the displays and settings shown in Table 5.1 List of functions.

Table 5.1 List of functions

No.	Function	Outline	Reference page
1	Main display	Displays the current temperature and set temperature of the circulating fluid and discharge pressure of the circulating fluid, and allows change of the set circulating fluid temperature.	5.3
2	Alarm display menu	Displays the alarm number when an alarm is generated.	5.4
3	Inspection monitor menu	As a part of the daily check, temperature, pressure and accumulated operating time can be checked. Use this menu for your daily check.	5.5
4	Key-lock	Keys can be locked to prevent the settings being changed by mistake made by an operator, etc.	5.6
5	Timer for operation start /stop	Operation of the product can be started or stopped with this timer function.	5.7
6	Ready completion [TEMP READY] signal	A signal is output when the circulating fluid temperature reaches the set temperature, when using contact input/output or serial communication.	5.8
7	Offset	Use this function when there is a temperature offset between the fluid discharge temperatures from the thermo-chiller and from the user's equipment.	5.9
8	Operation restoration after power failure	Start operation automatically after the power supply is turned ON.	5.10
9	Key click sound setting	Operation sound of the keys on the operation panel can be set ON/OFF.	5.12
10	Temp. unit change	Temperature unit can be changed: Centigrade (°C) ↔ Fahrenheit (°F)	5.13
11	Pressure unit change	Pressure unit can be changed: MPa ↔ PSI	5.14
12	Data reset	Use this function to reset the functions to the default settings.	5.15
13	Accumulated operation time reset	Reset the accumulated operation time when the pump, fan, compressor, or etc. is replaced. This function resets the accumulated operation time.	5.16
14	Anti-freezing	Circulating fluid is protected from freezing during winter or night. Set in advance when there is a risk of freezing.	5.11
15	Warming up	When the time required for increasing the temperature of the circulating fluid needs to be shortened at startup during winter or night, activate this function in advance.	5.17
16	Anti-snow coverage	If there will be a possibility of the snow coverage due to the change of the installation environment (season, weather), set beforehand	5.18
17	Alarm buzzer setting	Alarm buzzer can be set ON/OFF when an alarm is generated.	5.19
18	Alarm customizing	Operation and/or threshold can be changed while an alarm is being generated depending on the alarm type.	5.20
19	Communication	Use this function when using contact input/output or serial communication.	5.21

5.2 Function

5.2.1 Key operations

Fig. 5-1 “Key operation (1/2)” and “Key operation (2/2)” show the key operations of the thermo-chiller.

By pressing the [SEL] key for 1 second, the PV display blinks and the function of [SEL] key is reversed to allow reverse scrolling through the menu.

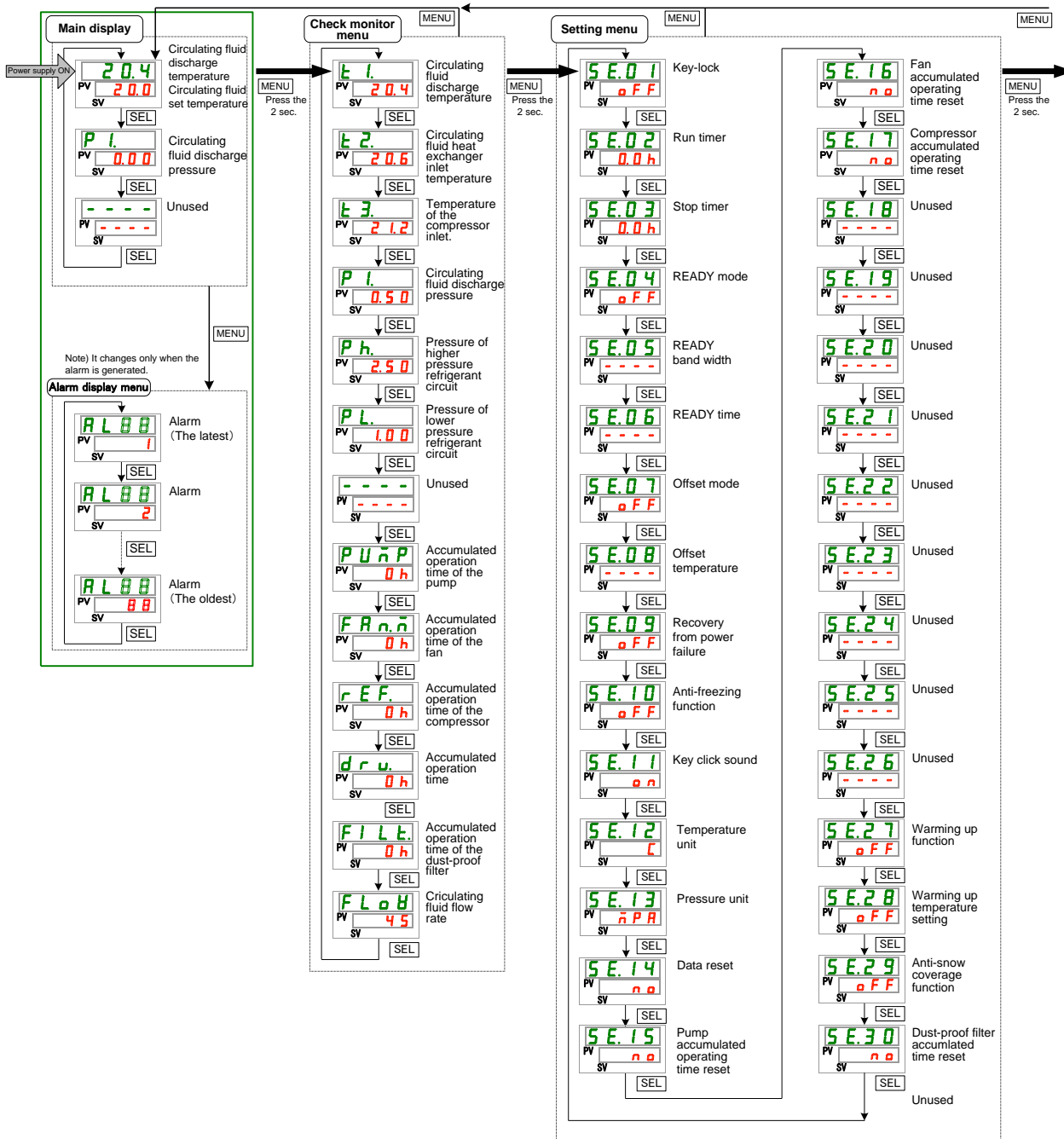

Fig. 5-1 Key operation (1/2)

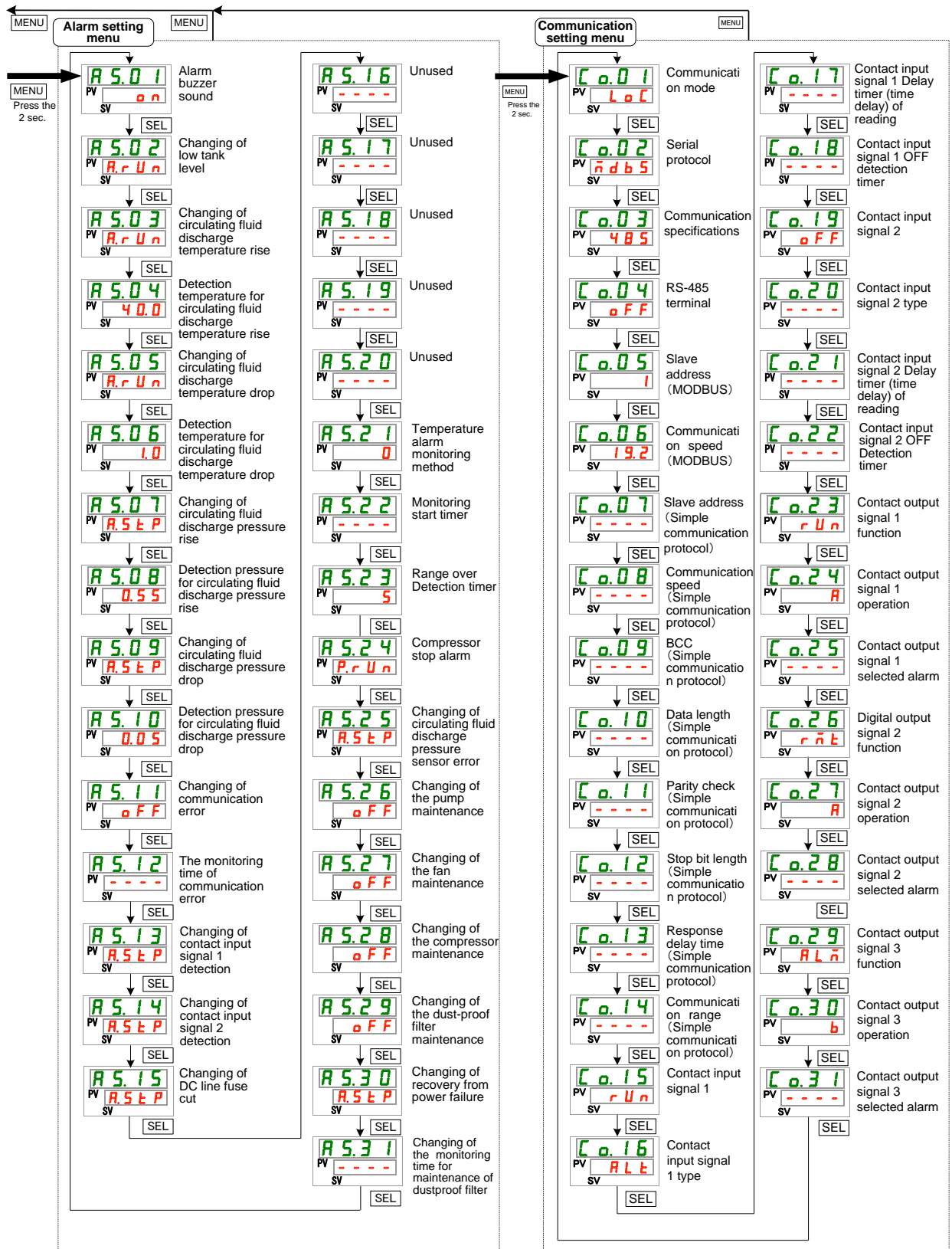

Fig. 5-2 Key operation (2/2)

5.2.2 List of parameters

“Table 5.2-1 List of parameters (1/3)” to “Table 5.2-3 List of parameters (3/3)” show the parameters of the thermo-chiller.

Table 5.2-1 List of parameters (1/3)

Display	Content	Default*1	Reference page	Category		
Temperature P I. <input type="text"/> - - - -	Circulating fluid temperature (TEMP PV)		5.3	Main display		
	Circulating fluid set temperature (TEMP SV)	20 °C (68°F)				
	Circulating fluid discharge pressure					
	Unused					
AL x x	Alarm No.		5.4	Alarm display menu		
E 1. <input type="text"/> E 2. <input type="text"/> E 3. <input type="text"/> P I. <input type="text"/> P h. <input type="text"/> P L. <input type="text"/> - - - - P U n P F R n n r E F. d r u. F I L E. F L o B	Circulating fluid discharge temperature Circulating fluid heat exchanger inlet temperature Compressor inlet temperature Circulating fluid discharge pressure Refrigerant circuit pressure on the high pressure side Refrigerant circuit pressure on the low pressure side Unused Accumulated operating time of the pump Accumulated operating time of the fan Accumulated operating time of the compressor Accumulated operating time of the thermo-chiller Accumulated operating time of the dust-proof filter Circulating fluid flow rate		5.5	Check monitor menu		
SE.01 SE.02 SE.03 SE.04 SE.05 SE.06 SE.07 SE.08 SE.09 SE.10 SE.11 SE.12 SE.13 SE.14 SE.15 SE.16 SE.17 SE.18 SE.19 SE.20 SE.21 SE.22 SE.23	Key-lock Run timer Stop timer READY mode READY band width READY time Offset mode Offset temperature Operation restoration after power failure Anti-freezing function Key click sound setting Temperature unit Pressure unit Data reset Accumulated operating time reset of the pump Accumulated operating time reset of the fan Accumulated operating time reset of the compressor Unused Unused Unused Unused Unused	OFF 0.0H 0.0H OFF ---- (0 °C (0 °F)) ^{*2} ---- (10) ^{*2} OFF ---- (0 °C (0 °F)) ^{*3} OFF OFF ON C MPa NO NO NO ---- ---- ---- ---- ----			5.6 5.7 5.8 5.9 5.10 5.11 5.12 5.13 5.14 5.15 5.16	Setting menu

*1: Initial values are shown in Fahrenheit (□□ oF) when the temperature unit is set to F for SE12.

*2: Default when SE04 is set ON.

*3: Default when SE07 is set to MD1, 2 or 3.

Table 5.2-2 List of parameters (2/3)

Display	Content	Default ^{*4}	Reference page	Category
SE27	Warming up function	OFF	5.17	Setting menu
SE28	Set temperature for warming up	---- 20.0 °C (68.0 ° F) ^{*5}		
SE29	Anti-snow coverage	OFF		
SE30	Dust-proof filter accumulated time reset	NO		
SE31	Unused	----		
AS01	Alarm buzzer	ON	5.19	Alarm setting menu
AS02	Operation setting when "Low level in tank" is generated	A.STP	5.20	
AS03	Operation setting when "Detection temp. for the circulating fluid discharge temp. rise" alarm is generated	A.RUN		
AS04	Threshold temperature setting for "Detection temp. for the circulating fluid discharge temp. rise" alarm	40.0 °C (104.0 ° F) (----) ^{*6}		
AS05	Operation setting when "Detection temp. for the circulating fluid discharge temp. drop" alarm is generated	A.RUN		
AS06	Threshold temperature setting for "Detection temp. for the circulating fluid discharge temp. drop" alarm	1.0 °C (33.8 ° F) (----) ^{*6}		
AS07	Operation setting when "Circulating fluid discharge pressure rise" alarm is generated	A.STP		
AS08	Threshold pressure setting for "Circulating fluid discharge pressure rise" alarm	0.70MPa (102PSI) (----) ^{*6}		
AS09	Operation setting when "Circulating fluid discharge pressure decrease" alarm is generated	A.STP		
AS10	Threshold pressure setting for "Circulating fluid discharge pressure decrease" alarm	0.03MPa (7PSI) (----) ^{*6}		
AS11	Operation setting when "Communication error" alarm is generated	OFF		
AS12	Threshold monitoring time setting for "Communication error"	---- (30) ^{*6}		
AS13	Setting function for "Contact input signal 1" detection	A.STP		
AS14	Setting function for "Contact input signal 2" detection	A.STP		
AS15	Operation setting when "DC line fuse cut" alarm is generated	A.STP		
AS16	Unused	----		
AS17	Unused	----		
AS18	Unused	----		
AS19	Unused	----		
AS20	Unused	----		

*4: Values are shown in °F when the unit is set to F for SE12, and in PSI when the unit is set to PSI for SE13.

*5: Default value when SE27 is ON.

*6: For more details of the default settings, refer to "5.20 Alarm Customizing Function".

Table 5.2-3 List of parameters (3/3)

Display	Content	Default	Reference page	Category	
A 5.2 1	Temperature alarm monitoring method	0	5.20	Alarm setting menu	
A 5.2 2	Operation setting for the monitoring start timer	---- (0) ^{*6}			
A 5.2 3	Threshold time setting for the range over detection timer	5			
A 5.2 4	Alarm settings for the compressor	P.RUN			
A 5.2 5	Operation setting when "Circulating fluid discharge pressure sensor failure " alarm is generated	A.STP			
A 5.2 6	Operation setting during maintenance of the pump	OFF			
A 5.2 7	Operation setting during maintenance of the fan	OFF			
A 5.2 8	Operation setting during maintenance of the compressor	OFF			
A 5.2 9	Operation setting during maintenance of the dust-proof filter	OFF			
A 5.3 0	Operation setting at a time of operation restoration after power failure	A.STP			
A 5.3 1	Changing of the dust-proof filter maintenance time	----			
C o. 0 1	Communication mode	LOC	5.21	Communication setting menu	
C o. 0 2	Serial protocol	MDBS			
C o. 0 3	Communication specification	485			
C o. 0 4	RS-485 terminating resistor	OFF			
C o. 0 5	Mod bus	Slave address			1 (----) ^{*7}
C o. 0 6		Communication speed			19.2 (----) ^{*7}
C o. 0 7	Serial communication simple communication protocols	Slave address			---- (1) ^{*7}
C o. 0 8		Communication speed			---- (9.6) ^{*7}
C o. 0 9		BCC			---- (ON) ^{*7}
C o. 1 0		Data length			---- (8BIT) ^{*7}
C o. 1 1		Parity check			---- (NON) ^{*7}
C o. 1 2		Stop bit length			---- (2BIT) ^{*7}
C o. 1 3		Response delay time			---- (0) ^{*7}
C o. 1 4		Communication range			---- (RW) ^{*7}
C o. 1 5	Contact input/output communication	Contact input signal 1			RUN
C o. 1 6		Contact input signal 1 type			ALT
C o. 1 7		Contact input signal 1 delay timer (time delay) for reading			---- (0) ^{*7}
C o. 1 8		Contact input signal 1 OFF detection timer			---- (0) ^{*7}
C o. 1 9		Contact input signal 2			OFF
C o. 2 0		Contact input signal 2 type			ALT
C o. 2 1		Contact input signal 2 delay timer (time delay) of reading			---- (0) ^{*7}
C o. 2 2		Contact input signal 2 OFF detection timer			---- (0) ^{*7}
C o. 2 3		Contact output signal 1 function			RUN
C o. 2 4		Contact output signal 1 operation			A
C o. 2 5		Contact output signal 1 selected alarm			---- (AL.01) ^{*7}
C o. 2 6		Contact output signal 2 function			RMT
C o. 2 7		Contact output signal 2 operation			A
C o. 2 8		Contact output signal 2 selected alarm			---- (AL.01) ^{*7}
C o. 2 9	Contact output signal 3 function	ALM			
C o. 3 0	Contact output signal 3 operation	B			
C o. 3 1	Contact output signal 3 selected alarm	---- (AL.01) ^{*7}			

*6: For more details of the default settings, refer to "5.20 Alarm Customizing Function".

*7: For more details of the default settings, refer to "5.21 Communication Function".

5.3 Main Display

5.3.1 Main display

The current temperature and the set temperature of the circulating fluid are shown on the main display, and the main display allows the set temperature to be changed.

5.3.2 Items on the main display

Items shown below are shown on the main display.

Display: Current circulating fluid discharge temperature

1. Turn ON the power supply switch.

The current temperature and the set temperature are displayed on the digital display.

* "Alarm menu" screen is displayed when any alarm is generated. (See "5.4")

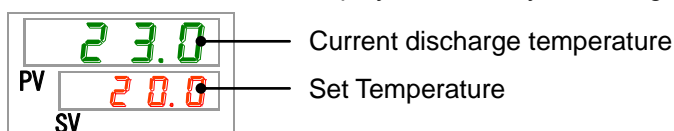

Setting: Circulating fluid temperature

2. Change the set temperature with the [▼] or [▲] key.

After changing the set temperature, set it by pressing the [SEL] key.

* The letters of the set value blink while the set value is being entered.

* If [SEL] key is not pressed, the value is set to the value after change 3 seconds later.

Display: Circulating fluid discharge pressure

3. Press the [SEL] key.

Circulating fluid discharge pressure is displayed on the digital display.

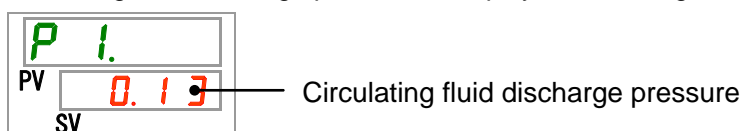

5.4 Alarm Menu

5.4.1 Alarm menu

The alarm menu display appears when an alarm is generated.

* The alarm menu is not accessible when no alarm has been generated.

* Refer to “Chapter 6 Alarm Notification and Troubleshooting” for details of the alarms.

5.4.2 Items shown on the alarm menu display

The alarm menu display appears when an alarm is being generated.

When multiple alarms are being generated, the latest alarm is shown on the display.

Each time the [SEL] key is pressed, the alarms are displayed in order, starting from the latest one.

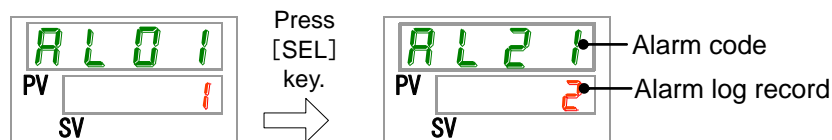

The main display is shown when the alarm is reset.

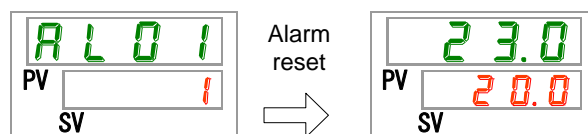

The main display is shown when [MENU] key is pressed while an alarm is being generated.

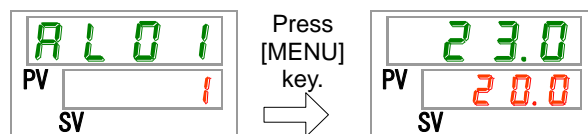

The alarm menu display is shown when [MENU] key is pressed again.

5.5 Check Monitor Menu

5.5.1 Check monitor menu

As a part of the daily inspection, the temperature, pressure and accumulated operating time can be checked.

Please use this for confirmation of your daily inspection.

5.5.2 Checking with the check monitor menu

The table below explains the check items in the check monitor menu.

Table 5.5-1 Check items in the check monitor menu

Display	Item	Content
E 1.	Circulating fluid discharge temperature	Displays the circulating fluid discharge temperature. Offset temperature is not taken into consideration in this temperature.
E 2.	Circulating fluid heat exchanger inlet temperature	Displays the circulating fluid temperature at the heat exchanger inlet.
E 3.	Compressor inlet temperature	Displays the refrigerant temperature at the compressor inlet port.
P 1.	Circulating fluid discharge pressure	Displays the circulating fluid discharge pressure.
P h.	Refrigerant circuit pressure on the high pressure side	Displays the pressure on the higher pressure side of the refrigerant circuit.
P L.	Refrigerant circuit pressure on the low pressure side	Displays the pressure on the lower pressure side of the refrigerant circuit.
- - - -	Unused	-
P U ű P	Accumulated operating time of the pump	Displays the accumulated operating time of the pump.
F A ű ű	Accumulated operating time of the fan	Displays the accumulated operating time of the fan motor.
r E F.	Accumulated operating time of the compressor	Displays the accumulated operating time of the compressor.
d r u.	Accumulated operating time of the thermo-chiller	Displays the accumulated operating time of the thermo-chiller.
F I L E.	Accumulated operating time of the dust-proof filter	Displays the accumulated operating time of the dust-proof filter.
F L o ű	Circulating fluid flow rate	Displays the circulating fluid flow rate. This is not a measured value with a flow meter, and is provided as a guide.

Checking: Circulating fluid discharge temperature

1. Press and hold the [MENU] key for approximately 2 seconds.

Circulating fluid discharge temperature display "E 1." appears on the digital display.

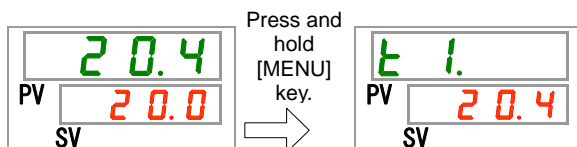

Displays the circulating fluid temperature discharged from this product to the user's equipment. Offset temperature is not taken into consideration in this temperature.

Checking: Circulating fluid temperature at the heat exchanger inlet

2. Press the [SEL] key once.

Display of the circulating fluid temperature at the heat exchanger inlet appears on the digital display.

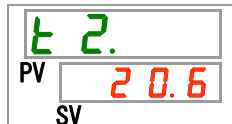

Displays the circulating fluid temperature returning from the user's equipment.

Checking: Inlet refrigerant temperature to the compressor.

3. Press the [SEL] key once.

Display of the inlet refrigerant temperature to the compressor appears on the digital display.

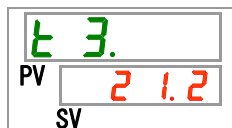

Displays the refrigerant temperature at the compressor inlet port.

Checking: Circulating fluid discharge pressure

4. Press the [SEL] key once.

Display of the circulating fluid discharge pressure appears on the digital display.

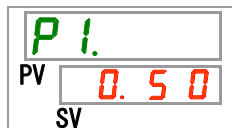

Displays the circulating fluid pressure fed from this product to the user's equipment.

Checking: Refrigerant circuit pressure on the high pressure side

5. Press the [SEL] key once.

Display of the refrigerant circuit pressure on the high pressure side appears on the digital display.

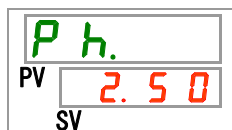

Displays the pressure of the high pressure side of the refrigerant circuit.

Checking: Refrigerant circuit pressure on the low pressure side

6. Press the [SEL] key once.

Display of the refrigerant circuit pressure on the low pressure side appears on the digital display.

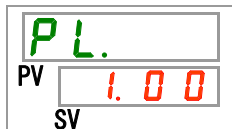

Checking: Accumulated operating time of the pump

7. Press the [SEL] key once.

Display of the accumulated operating time of the pump appears on the digital display.



Refer to the table below for details of the display.

Table 5.5-2 Time display

Accumulated time	Displayed value
0h to 999h	0 h to 999 h
1,000h to 99,999h	1 h h to 99 h h
100,000h	Return to 0 h

AL28 Pump maintenance alarm is generated when the accumulated operating time of the pump reaches 20,000 hours (20 h h) (when set to "A.RUN"). For more details, refer to "Chapter 6 Alarm Notification and Troubleshooting".

Checking: Accumulated operating time of the fan

8. Press the [SEL] key once.

Display of the accumulated operating time of the fan appears on the digital display.



Refer to "Table 5.5-2 Time display" for the display.

AL29 Fan maintenance alarm is generated when the accumulated operating time of the fan motor reaches 30,000 hours (30 h h) (when set to "A.RUN"). For details, refer to "Chapter 6 Alarm Notification and Troubleshooting".

Checking: Accumulated operating time of the compressor

9. Press the [SEL] key once.

Display of the accumulated operating time of the compressor appears on the digital display.

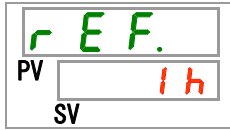

Refer to “Table 5.5-2 Time display” for the display.

AL30 Compressor maintenance alarm is generated when the accumulated operating time of the compressor reaches 30,000 hours (**30 h h**) (when set to “A.RUN”). For more details, refer to “Chapter 6 Alarm Notification and Troubleshooting”.

Checking: Accumulated operating time of the thermo-chiller

10. Press the [SEL] key once.

The accumulated operating time of the thermo-chiller appears on the digital display.

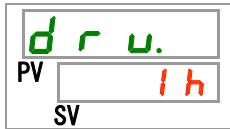

Refer to “Table 5.5-2 Time display” for the display.

Checking: Accumulated operating time of the dust-proof filter

11. Press the [SEL] key once.

Display of the accumulated operating time of the dust-proof filter appears on the digital display.

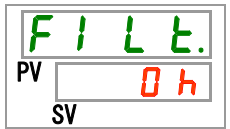

Refer to “Table 5.5-2 Time display” for the display.

AL40 Dust-proof filter maintenance alarm is generated when the accumulated operating time of the dust-proof filter reaches 500 hours (**5 0 0 h**) (when set to “A.RUN”). For more details, refer to “Chapter 6 Alarm Notification and Troubleshooting”.

Checking: Circulating fluid flow rate

12. Press the [SEL] key once.

Display of the circulating fluid flow rate appears on the digital display.

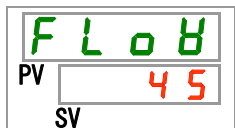

Circulating fluid flow rate of this product is displayed as a guide. Unit: L/min.

This is not a measured value, and is provided as a guide.

5.6 Key-lock

5.6.1 Key-lock

The keys can be locked to prevent the settings being changed by an operator error. Operation can be started / stopped by operating the "RUN/STOP" key even when the key-lock is being activated.

If you try to change the set value with the "▲" key or "▼" key while the key-lock function is activated, "LoCk" will be displayed for 1 second, and it is not possible to change the set value. (Refer to the Fig. below.)

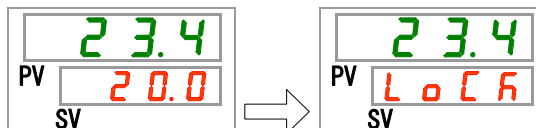

⚠ CAUTION



While the key-lock function is being activated, no other setting is available.

Release the key-lock setting for other settings.

5.6.2 Key-lock setting / checking

The table below explains the setting items of the key-lock function and the initial values.

Table 5.6-1 Set items for key-lock

Display	Item	Contents	Default
SE.O I	Key-lock	Sets the key-lock function ON. When the key-lock function is set ON, no other settings are available.	OFF

1. Press and hold the [MENU] key for approximately 2 seconds.

Repeat pressing the key until the key-lock setting screen [SE.O I] appears on the digital display

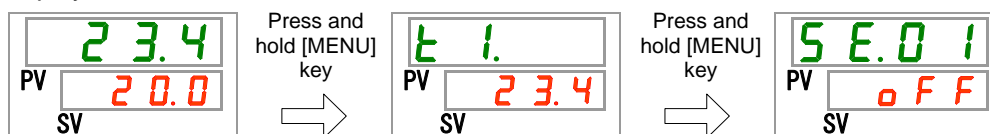

Setting/checking: Key-lock function

2. Select "ON" with [▲] key or [▼] key, and enter with the "SEL" key.

Table 5.6-2 Setting of the key-lock function

Set value	Explanation	Default
OFF	Key-lock function OFF	✓
ON	Key-lock function ON	

3. Press the [MENU] key once.

Returns to the main display (which shows the circulating fluid temperature).

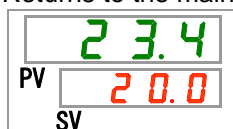

5.7 Run Timer and Stop Timer Function

5.7.1 Run timer and stop timer function

This function starts or stops operation of the product automatically when the set time has passed. The time can be set according to the user's working hours. Set the circulating fluid temperature in advance.

[Run timer] is a function to start operation after a set time. [Stop timer] is a function to stop operation after a set time. It is possible to set both [Run timer] and [Stop timer]. The set time of both the [Run timer] and [Stop timer] can be 99.5 hours at maximum, in 0.5 hour units.

[When communication is used]

If the communication mode is DIO REMOTE or SERIAL mode, this function does not operate. DIO REMOTE and SERIAL mode operation/stop signals have priority.

- Run timer

Run timer starts operation after the set time.

If the thermo-chiller is already operating or the pump is operating independently, this function does not operate even when the set time has passed.

Operation can start when the product condition is normal and there is no alarm generated.

The [⌚] light turns ON when the run timer is set. The [⌚] light is turned OFF when the operation is started by the run timer.

The [⌚] light does not turn OFF while the stop timer is being activated.

The run timer setting is reset when the main power supply is cut or a power failure occurs. Please set it again.

- Stop timer

The [⌚] light turns ON when the stop timer is set. The [⌚] light turns OFF when the operation is stopped by the stop timer.

The [⌚] light does not turn OFF while the run timer is being activated. The stop timer setting is reset when the main power supply is stopped or a power failure occurs. Please set it again.

Timer setting examples

Run timer
Set to start 3 hours later

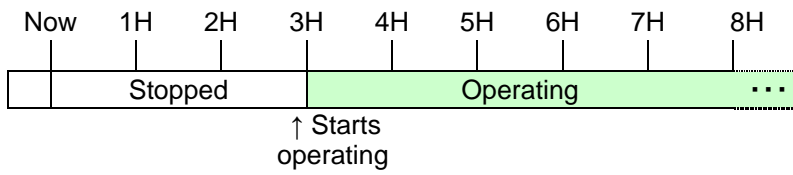

Stop timer
Set to stop 3 hours later

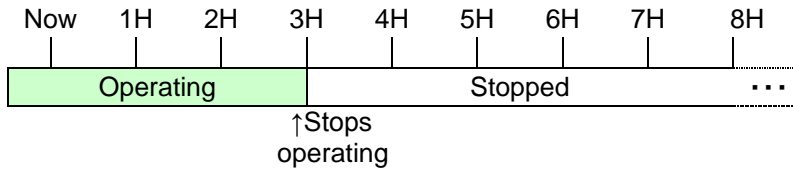

Run timer +
Stop timer
Set to start 2 hours later,
and stop 5.5 hours later

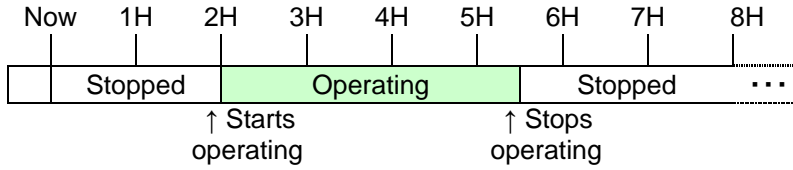

Stop timer +
Start timer
Set to stop 2 hours later,
and start 5.5 hours later

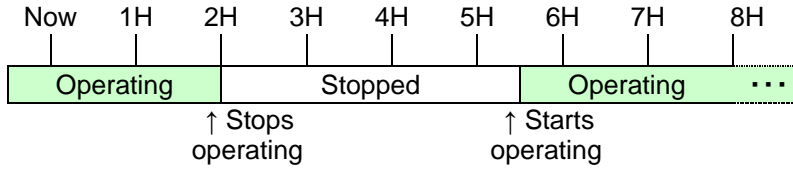

CAUTION



- Set while the breaker is ON (while the power is supplied).
- The setting is released when operation is started or stopped by the timer. Setting is necessary again to use the timer next time as well.
- Run timer setting is released when the breaker or the user's power supply facility is cut, or a power failure occurs. Please set it again.

5.7.2 Setting and checking of run timer and stop timer function

The table below explains the setting items of the run/stop timer and the initial values.

Table 5.7-1 Setting of run timer and stop timer

Display	Item	Contents	Default
SE.02	Run timer	Sets time before the product operation starts.	0.0 H
SE.03	Stop timer	Sets time before the product operation stops.	0.0 H

This section explains how to set/check both the run timer and the stop timer in sequence. Please refer to the setting or checking instructions of the timer that is to be used.

1. Press and hold the [MENU] key for approximately 2 seconds.

Repeat pressing the key until the key-lock setting display [SE.01] appears on the digital display.

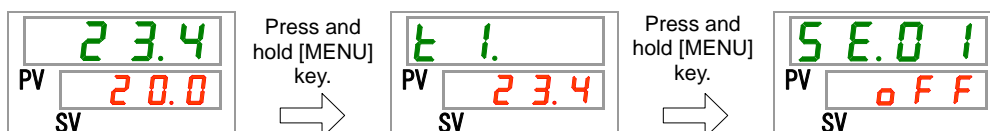

Setting/checking: Run timer

2. Press the [SEL] key once.

Setting screen of the run timer is displayed on the digital display.



3. Select run timer with [▲] key or [▼] key, and press [SEL] key to enter.

Table 5.7-2 List of set value

Set value	Explanation	Default
0.0 h	Timer OFF	✓
0.5 h to 99.5 h	The product will start automatically after the lapse of set time. Setting unit: 0.5 hours	

For example: Run timer setting performed at 5:30 PM on the previous day to start the product operation 14 hours later (at 7:30 AM on the next morning)



Setting/checking: Stop timer

4. Press the [SEL] key once.

Setting screen of the stop timer appears on the digital display.

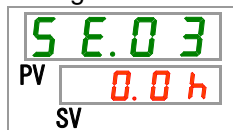

5. Select stop timer with the [▲] key or the [▼] key, and press [SEL] key to enter.

Table 5.7-3 Setting of the stop timer

Set value	Explanation	Default
0.0 h	Timer OFF	✓
0.5 h to 99.5 h	The product will stop automatically after the lapse of set time. Setting unit: 0.5 hours	

For example: Stop timer setting performed at 4:30 PM to stop the product operation 1.5 hours later (at 6:00 PM).



6. Press the [MENU] key once.

Returns to the display showing the circulating fluid temperature.

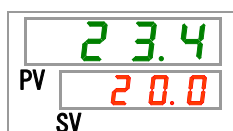

7. Once the run timer is set, keep the power supply to the product ON. The product will start automatically after the set time.

When the stop timer is set, leave the product running. The product will stop automatically after the set time.

5.8 Ready Completion (TEMP READY) Signal

5.8.1 Ready completion (TEMP READY) signal

This function sets a bandwidth for the set circulating fluid temperature (range between the upper and lower limit temperatures) to notify the user by communication that the circulating fluid temperature has reached the band range. The default setting of this function is "OFF".

Tips

This function is available when contact input/output and serial communication is being used. Refer to the Communications Operation Manual for further details.

An example is shown below:

Set circulating fluid temperature:	20 °C
READY bandwidth (range between the upper and lower limit temperatures):	±2 °C
READY time:	60 seconds

Preparation for operation will be completed 60 seconds after the circulating fluid temperature reaches the range of 18 °C to 22 °C.

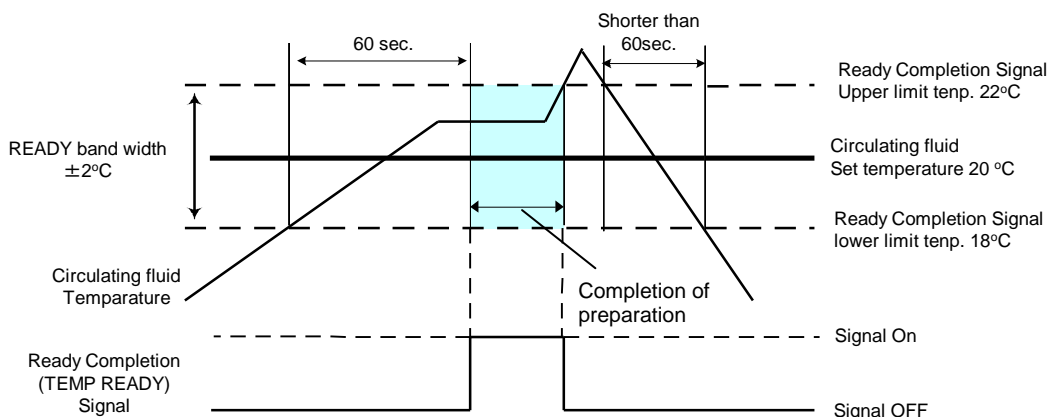

5.8.2 Ready completion (TEMP READY) signal setting / checking

The table below shows explanation and default of the set items for ready completion (TEMP READY) signal.

Table 5.8-1 Set items for ready completion (TEMP READY) signal

Display	Item	Content	Default
5 E.04	READY mode	Sets ready completion (TEMP READY) signal	OFF
5 E.05	READY bandwidth (range between the upper and lower limit temperatures)	Sets temperature for ready completion (TEMP READY) signal.	----
5 E.06	READY time	Sets time for ready completion (TEMP READY) signal.	----

1. Press and hold the [MENU] key for approximately 2 seconds.

Repeat pressing the key until the key-lock setting display [5 E.01] appears on the digital display.

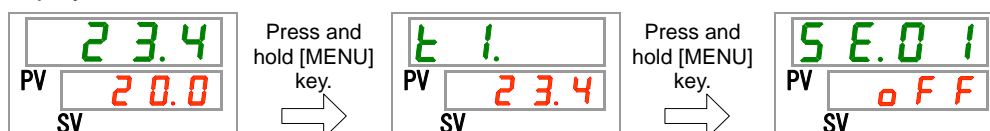

Setting/checking: READY mode

2. Press the [SEL] key 3 times.

Setting screen of READY mode appears on the digital display.

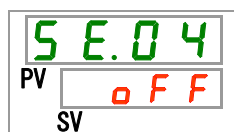

3. Select "ON" with [▲] key or [▼] key, and enter with the "SEL" key.

Table 5.8-2 Setting of READY mode

Set value	Explanation	Default
OFF	Ready completion (TEMP READY) signal OFF	✓
ON	Ready completion (TEMP READY) signal ON	

Setting/checking: READY bandwidth

4. Press the [SEL] key once.

READY bandwidth (range between the upper and lower limit temperatures) setting screen appears on the digital display.



5. Select READY bandwidth with [▲] key or [▼] key, and enter by pressing the [SEL] key.

Table 5.8-3 Set value for READY mode

Set value	Explanation	Default
----	Sets READY bandwidth (range between the upper and lower limit temperatures) for the set circulating fluid temperature.	
Centigrade 0.0 to 5.0	Setting of READY bandwidth (range between the upper and lower limit temperatures) for the set circulating fluid temperature.	0.0
Fahrenheit 0.0 to 9.0		0.0

Setting/checking: READY time

6. Press the [SEL] key once.

Setting screen of READY time appears on the digital display.



7. Set READY time with [▲] key or [▼] key, and enter with the [SEL] key.

Table 5.8-4 Set value

Set value	Explanation	Default
----	Setting and checking are not available when READY mode setting is OFF.	
1.0 to 9999	Sets time that is to maintain the set circulating fluid temperature before starting the product operation. Setting unit: 1 second	1.0

8. Press the [MENU] key once.

Returns to the main display (which shows the circulating fluid temperature).

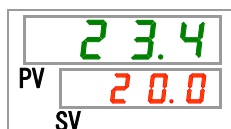

5.9 Offset Function

5.9.1 Offset function

This is a function that controls the "circulating fluid display temperature" and the "target temperature for chiller temperature control" by shifting the temperature for the set offset value.

This product has three different modes of offset functions (MODE 1 to 3).

(The default setting of this function is "OFF".)

See "

Table 5.9-1 Offset function" shown below for these modes.

Refer to "5.9.2 Usage example of offset function" for operation methods.

Refer to "5.9.3 Setting/checking of offset function" for the setting instructions.

[When communication is being used]

The circulating fluid temperature sent by serial communication is the circulating fluid temperature (the circulating fluid temperature after offset) which is displayed on the thermo-chiller.

Table 5.9-1 Offset function

Offset function	Circulating fluid display temperature	Temperature control
MODE1	Displays the "circulating fluid discharge temperature".	Circulating fluid temperature is controlled to be "the set circulating fluid temperature plus offset temperature".
MODE2	Displays the temperature that is "circulating fluid discharge temperature plus offset temperature".	Circulating fluid temperature is controlled to be "the set circulating fluid temperature".
MODE3	Displays the temperature that is "circulating fluid discharge temperature minus offset temperature".	Circulating fluid temperature is controlled to be "the set circulating fluid temperature plus offset temperature".
OFF (Default)	Displays the "circulating fluid discharge temperature".	Circulating fluid temperature is controlled to be "the set circulating fluid temperature".

5.9.2 Usage example of offset function

Suppose that the circulating fluid discharge temperature of this thermo-chiller is 30 °C and the circulating fluid temperature that enters the user's equipment is 29 °C due to temperature drop while it is transferred to the user's equipment in the piping:

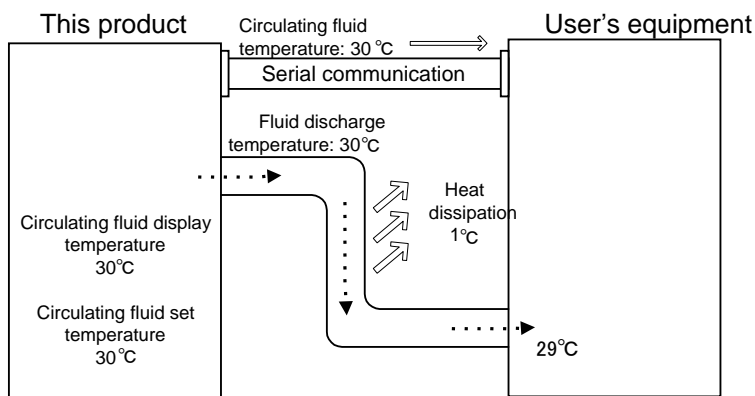

- When only the "set circulating fluid temperature" needs to be the same as the circulating temperature supplied to the user's equipment:

Use "MODE 1" of the offset function, and set the offset temperature to "1.0" °C.

The thermo-chiller controls the circulating fluid temperature aiming at 31°C (set circulating fluid temperature plus offset temperature).

The displayed circulating fluid temperature is the fluid temperature discharged from the thermo-chiller (31 °C).

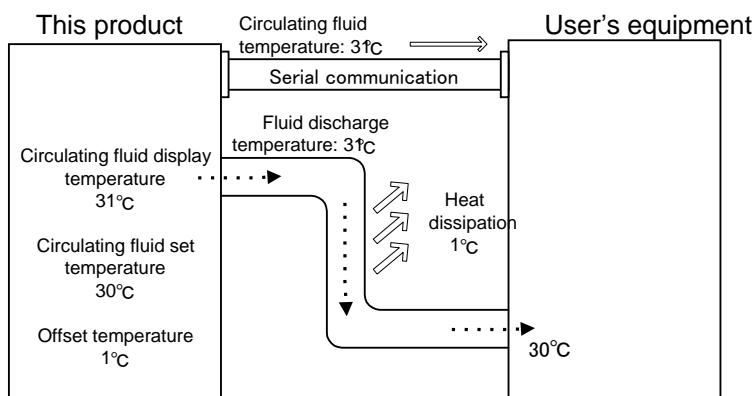

■ When only the "displayed circulating fluid temperature" needs to be the same as the circulating temperature supplied to the user's equipment:

Use "MODE 2" of the offset function, and set the offset temperature to "-1.0" °C.

1. The thermo-chiller controls the circulating fluid temperature aiming at 30°C (set circulating fluid temperature).
2. 29 °C (the actual fluid temperature of 30 °C minus the offset temperature of 1 °C) will be displayed as the circulating fluid temperature.

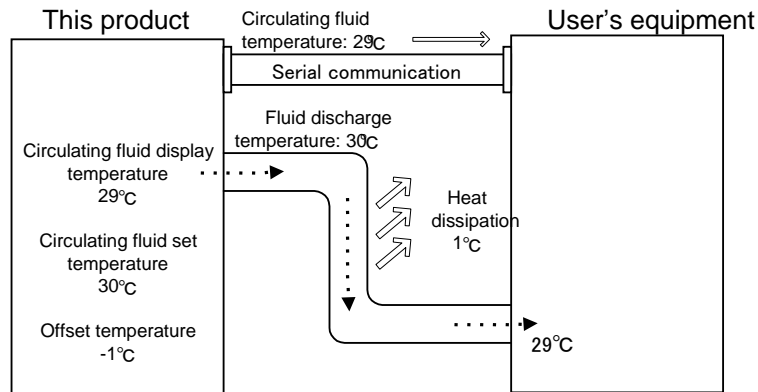

■ When both the "set circulating fluid temperature" and the "displayed circulating fluid temperature" need to be the same as the circulating temperature supplied to the user's equipment:

Use "MODE 3" of the offset function, and set the offset temperature to "1.0" °C.

1. The thermo-chiller controls the circulating fluid temperature aiming at 31°C (set circulating fluid temperature plus offset temperature).
2. The displayed circulating fluid temperature is the fluid temperature discharged from the thermo-chiller (31 °C minus the offset temperature).

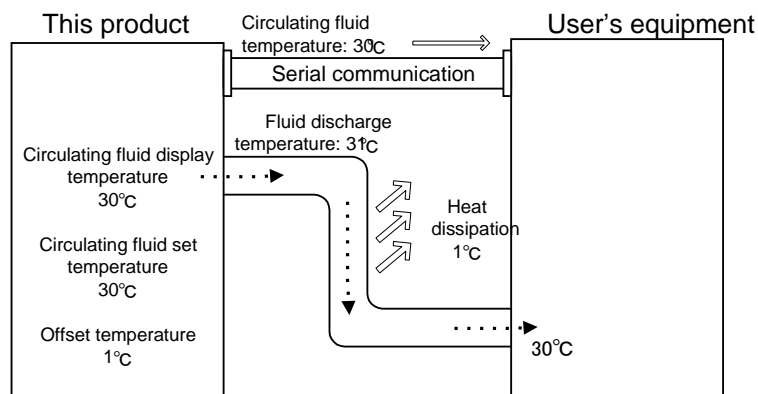

5.9.3 Setting/checking of offset function

The table below shows the set items of the offset function and the default values.

Table 5.9-2 Set items for offset function

Display	Item	Contents	Default
SE07	Offset mode	Offset mode is set ON/OFF.	OFF
SE08	Offset temperature	Sets offset temperature.	---

1. Press and hold the [MENU] key for approximately 2 seconds.

Repeat pressing the key until the key-lock setting screen [SE01] appears on the digital display.

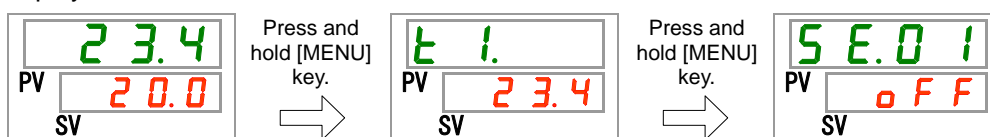

Setting/Checking: Offset mode

2. Press the [SEL] key 6 times.

Setting screen of offset mode appears on the digital display.



3. Select offset mode with [▲] key or [▼] key, and press the [SEL] key to enter.

Table 5.9-3 Offset function setting

Set value	Explanation	Default
OFF	Offset function OFF	✓
nd1	Offset mode 1	
nd2	Offset mode 2	
nd3	Offset mode 3	

Setting/Checking: Offset temperature

4. Press the [SEL] key once.

Setting screen of offset temperature appears on the digital display.

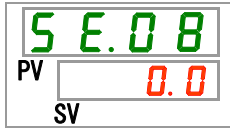

5. Set offset temperature with [▲] key or [▼] key, and press [SEL] key to enter.

Table 5.9-4 Offset temperature setting

Set value	Explanation	Default
---	Setting and checking are not available when offset mode setting is OFF.	
Centigrade - 20.0 to 20.0	Offset temperature is set.	0.0
Fahrenheit - 36.0 to 36.0		0.0

CAUTION

- This function adjusts the offset temperature in accordance with the circulating fluid discharge temperature.
- Circulating fluid temperature is controllable in the range of 5.0 °C to 35.0 °C (41.0 °F to 95.0 °F).
- Note that when the circulating temperature is set to 5.0 °C (41 °F) and the offset temperature is set to -20.0 °C (-36.0 °F), some of the offset modes automatically adjust the offset temperature to 0.0 °C (0.0 °F).

6. Press the [MENU] key once.

Returns to the main display (which shows the circulating fluid temperature).

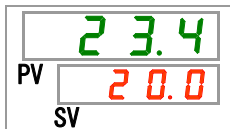

5.10 Operation Restoration after Power Failure

5.10.1 Operation restoration function after power failure

When the power supply is cut due to power failure, etc., this function restarts the operation when the power supply restores, retaining the conditions before the power cut.

[When communication is being used]

If the communication mode is DIO REMOTE or SERIAL mode (MODBUS), this function does not operate. DIO REMOTE and SERIAL mode (MODBUS) operation/stop signals have priority.

The [Ⓢ] light turns ON when the operation restoration function is set. The default setting of this function is "OFF". (AL41 "Power stoppage" alarm does not occur.)

5.10.2 Setting/checking of the operation restoration function

The table below shows the setting items of the operation restoration after power failure function and the default setting.

Table 5.10-1 Set item for operation restoration after power failure function

Display	Item	Contents	Default
SE.09	Operation restoration after power failure	Sets operation restoration after power failure function.	OFF

1. Press and hold the [MENU] key for approximately 2 seconds.

Repeat pressing the key until the key-lock setting screen [SE.01] appears on the digital display.

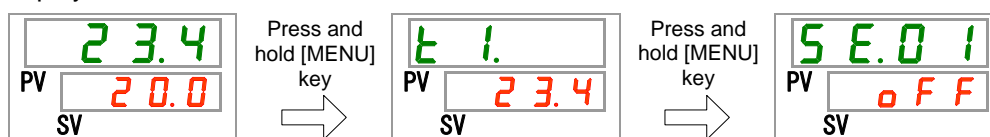

Setting/Checking: Operation restoration after power failure function

2. Press the [SEL] key 8 times.

Setting screen of operation restoration after power failure function appears on the digital display.



3. Select operation restoration function after power failure with [▲] key or [▼] key, and press [SEL] key to enter.

Table 5.10-2 Setting of "Operation restoration after power failure function"

Set value	Explanation	Initial value (Default setting)
OFF	Operation restoration after power failure function OFF	✓
ON	Operation restoration after power failure ON	

4. Press the [MENU] key once.

Returns to the main display (which shows the circulating fluid temperature).

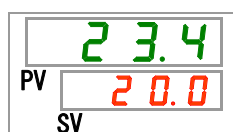

5.11 Anti-freezing Function

5.11.1 Anti-freezing function

CAUTION



Keep the power supply ON for this function. This function does not start when the power is OFF.

This function prevents freezing of the circulating fluid while the product stops operation in the winter season with heat generated by automatically operating the pump.

When there is a possibility of the circulating fluid freezing due to changes in the installation or operating environment (e.g. season, weather), set this function ON in advance.

- If the circulating fluid temperature falls down to 3 °C or less, the pump starts operation automatically.
- Heat generated by the pump operation warms up the circulating fluid. When the circulating fluid temperature reaches 5 °C or higher, the pump stops operation automatically.
- Repeated automatic operation start and stop of the pump maintains the circulating fluid temperature to 3 °C to 3 °C to prevent the circulating fluid from being frozen.

When the anti-freezing function is set ON, the [RUN] light blinks every 2 seconds while the pump is in the standby state (while the pump stops operation). The [RUN] light blinks every 0.3 seconds during the automatic operation of the pump. The default setting of this function is "OFF".

This function does not prevent the automatic water fill circuit from being frozen. Countermeasures against freezing of the automatic water fill circuit should be taken with the user's equipment.

Note that when the warming up function is ON, the warming up function has a priority over the anti-freezing function, and the anti-freezing function will not be activated. (See "5.17 Warming Up Function")

CAUTION



- **This function can be activated only when the power supply is ON and the thermo-chiller is not operating.**
- **Fully open the valve or manual bypass valve that is arranged by the user to make it possible for the circulating fluid to circulate when the pump starts automatic operation.**
- **In extremely cold weather, the heat generated by the pump operation may not be enough to prevent freezing of the circulating fluid.**
- **During the automatic operation, the pump does not stop even if the "RUN/STOP" key is pressed. To stop the pump, turn the power supply OFF or turn this function OFF.**
- **This function does not prevent the automatic water fill circuit from being frozen. Countermeasures against freezing of the automatic water fill circuit should be taken with the user's equipment.**

5.11.2 Setting/checking of anti-freezing function

The table below shows the set item of the anti-freezing function and the default setting.

Table 5.11-1 Set item for anti-freezing function

Display	Item	Contents	Default
SE.10	Anti-freezing function	Sets anti-freezing function ON/OFF.	OFF

1. Press and hold the [MENU] key for approximately 2 seconds.

Repeat pressing the key until the key-lock setting screen [SE.01] appears on the digital display.

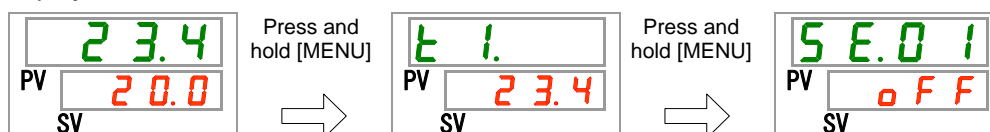

Setting/Checkign: Anti-freezing function

2. Press the [SEL] key 9 times.

Setting screen of anti-freezing function appears on the digital display.

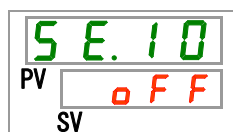

3. Select anti-freezing function with [▲] key or [▼] key, andpress [SEL] key to enter.

Table 5.11-2 Setting of anti-freezing function

Set value	Explanation	Default
OFF	Anti-freezing function OFF	✓
ON	Anti-freezing function ON	

4. Press the [MENU] key once.

Returns to the main display (which shows the circulating fluid temperature).

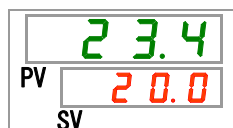

5.12 Key Operation Sound Setting

5.12.1 Key operation sound setting

Operation sound (click sound) of the keys on the operation panel can be set ON/OFF.

Default setting is key operation sound “ON”.

5.12.2 Setting/checking of the key operation sound

The table below shows the set item for key operation sound and the default setting.

Table 5.12-1 Set item for key operation sound

Display	Item	Contents	Default
SE.11	Key operation sound	Sets key operation sound ON/OFF.	ON

1. Press and hold the [MENU] key for approximately 2 seconds.

Repeat pressing the key until the key-lock setting screen [SE.01] appears on the digital display.

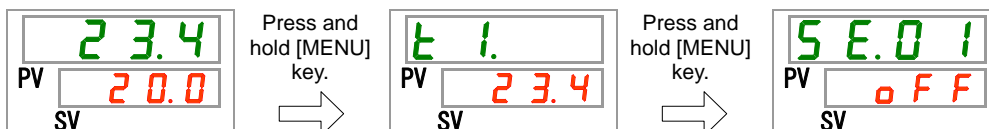

Setting/Checking: Key operation sound

2. Press the [SEL] key 10 times.

Setting screen of key operation sound appears on the digital display.



3. Set the key operation sound On/OFF with [▲] key or [▼] key, and press the “SEL” key to enter.

Table 5.12-2 Setting for key operation sound

Set value	Explanation	Default
OFF	Key operation sound OFF	
ON	Key operation sound ON	✓

4. Press the [MENU] key once.

Returns to the main display (which shows the circulating fluid temperature).

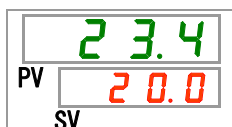

5.13 Temperature Unit Change

5.13.1 Temperature unit change

The temperature unit used for the thermo-chiller can be selected Celsius (°C) or Fahrenheit (°F). This setting determines the temperature unit which is displayed/output. The default setting is Celsius (°C).

-This feature is not valid with Option W, the unit is fixed Celsius (°C).

5.13.2 Setting/checking of temperature unit change

The table below shows the set item for the temperature unit change and the default setting.

Table 5.13-1 Set item for temperature unit change

Display	Item	Contents	Default
SE.12	Temperature unit	Sets temperature unit.	°C

1. Press and hold the [MENU] key for approximately 2 seconds.

Repeat pressing the key until the key-lock setting screen [SE.01] appears on the digital display.

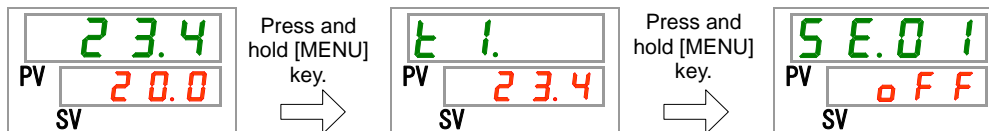

Setting/Checking: Temperature unit

2. Press the [SEL] key 11 times.

Setting screen of temperature unit appears on the digital display.

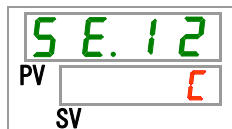

3. Select a temperature unit with [▲] key or [▼] key, and press [SEL] key to enter.

Table 5.13-2 Set items for temperature unit

Set value	Explanation	Default
C	Sets the temperature unit to Celsius (°C).	✓
F	Sets the temperature unit to Fahrenheit (°F).	

4. Press the [MENU] key once.

Returns to the main display (which shows the circulating fluid temperature).

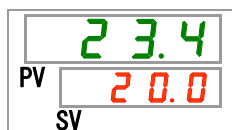

5.14 Pressure Unit Change

5.14.1 Pressure unit change

Pressure unit used for the thermo-chiller can be selected MPa or PSI. This setting determines the pressure unit which is displayed/ output. The default setting is MPa.

-This feature is not valid with Option W, the unit is fixed at MPa.

5.14.2 Setting/checking of pressure unit change

The table below shows the set item for the pressure unit change and the default setting.

Table 5.14-1 Set item for pressure unit change

Display	Item	Contents	Default setting
5 E.13	Pressure unit	Sets pressure unit.	MPa

1. Press and hold the [MENU] key for approximately 2 seconds.

Repeat pressing the key until the key-lock setting screen [5 E.01] appears on the digital display.

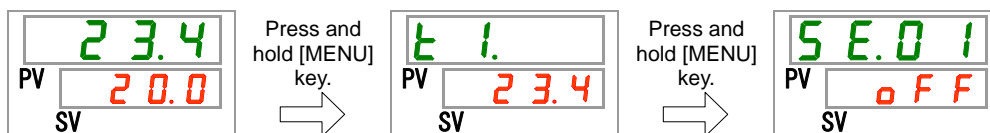

Setting/Checking: Pressure unit

2. Press the [SEL] key 12 times.

Setting screen of temperature unit appears on the digital display.

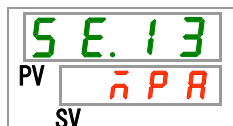

3. Select a pressure unit with [▲] key or [▼] key, and press [SEL] key to enter.

Table 5.14-2 Setting for pressure unit

Set value	Explanation	Default
n P A	Sets the pressure unit to MPa.	✓
P S I	Sets the pressure unit to PSI.	

4. Press the [MENU] key once.

Returns to the main display (which shows the circulating fluid temperature).

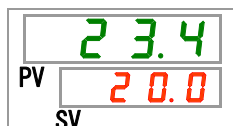

5.15 Data Reset Function

5.15.1 Data reset function

Resets the values set by user to the default values. Note that the accumulated operating time will not be reset.

⚠ CAUTION



**This function resets all the set values.
 Use caution when operating this function.
 It is recommended to record the set data before resetting.**

5.15.2 How to operate reset function

The table below shows the set item for data reset and the default setting.

Table 5.15-1 Set item for data reset

Display	Item	Contents	Default
SE.14	Data reset	Resets all the data. (Accumulated operation time will not be reset.)	NO

1. Press and hold the [MENU] key for approximately 2 seconds.

Repeat pressing the key until the key-lock setting screen [SE.01] appears on the digital display.

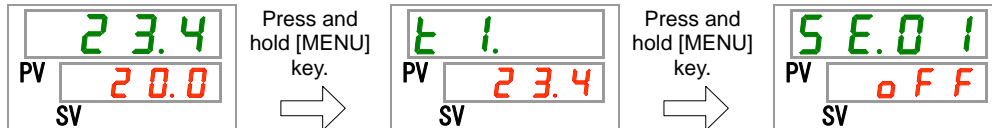

Data reset

2. Press the [SEL] key 13 times.

Data reset screen appears on the digital display.

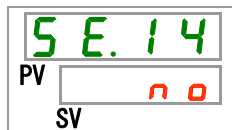

3. Select YES with [▲] key or [▼] key, and press [SEL] key to enter. Select YES and press [SEL] key to enter. This resets all the data to the default, and the display returns to the main display.

Table 5.15-2 Data reset

Set value	Explanation	Default
no	No data reset.	✓
YES	Resets all the data.	

5.16 Accumulated Operating Time Reset Function

5.16.1 Accumulated operating time reset function

The alarms shown below will be generated to notify the maintenance timing. The thermo-chiller does not stop operation for these alarms.

- Pump maintenance (AL28): Generated after 20,000 hours of accumulated operating time.
- Fan motor maintenance (AL29): Generated after 30,000 hours of accumulated operating time.
- Compressor maintenance (AL30): Generated after 30,000 hours of accumulated operating time
- Dust-proof filter maintenance (AL40): Generated after 500 hours of accumulated operating time.

To cancel the alarm, the accumulated operating time needs to be reset. Reset the accumulated operation time after replacing the parts (ask for service). It will start counting the accumulated operating time from the beginning.

5.16.2 How to operate accumulated operating time reset function

The table below shows the details of the accumulated operating time to be reset and the default settings.

Table 5.16-1 Accumulated operating time to be reset

Display	Item	Contents	Default
SE.15	Reset of accumulated operating time of the pump	Resets the accumulated operating time of the pump.	NO
SE.16	Reset of accumulated operating time of the fan	Resets the accumulated operating time of the fan.	NO
SE.17	Reset of accumulated operating time of the compressor	Resets the accumulated operating time of the compressor.	NO
SE.30	Reset of accumulated operating time of the dust-proof filter	Resets the accumulated operating time of the dust-proof filter.	NO

Refer to the corresponding paragraph for how to reset the accumulated operating time of the required item.

Reset of accumulated operati time of the pump

1. Press and hold the [MENU] key for approximately 2 seconds.

Repeat pressing the key until the key-lock setting screen [SE.01] appears on the digital display.

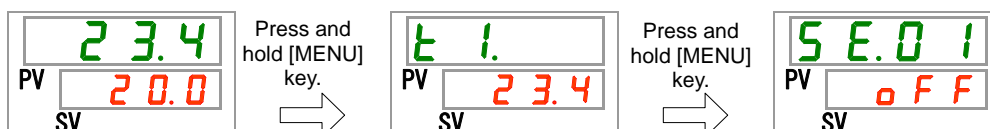

2. Press the [SEL] key 14 times.

Resetting screen of the pump accumulated operating time appears on the digital display.

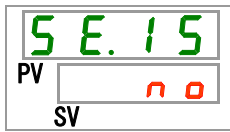

3. Select with [▲] key or [▼] key, and press [SEL] key to enter. Select and press [SEL] key to enter, and the accumulated operating time of the pump will be reset. The display returns to the main menu.

Table 5.16-2 Resetting of accumulated operating time of the fan

Set value	Explanation	Default
<input type="text" value="no"/>	No data reset.	✓
<input type="text" value="YES"/>	Resets the accumulated operating time of the pump.	

Reset of accumulated operating time of the fan

4. Press and hold the [MENU] key for approximately 2 seconds.

Repeat pressing the key until the key-lock setting screen [**SE.01**] appears on the digital display.

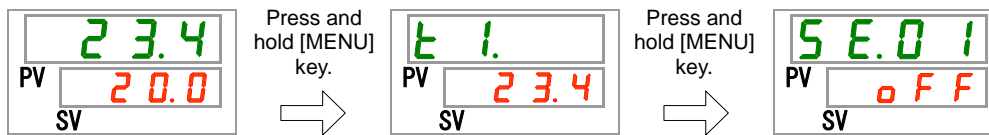

5. Press the [SEL] key 15 times.

Resetting screen of the fan accumulated operating time appears on the digital display.

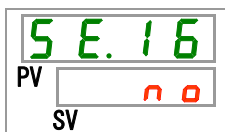

6. Select with [▲] key or [▼] key, and press "SEL" key to enter. Select and press [SEL] key to enter, and the accumulated operating time of the fan will be reset. The display returns to the main menu.

Table 5.16-3 Reset setting

Set value	Explanation	Default
<input type="text" value="no"/>	No data reset.	✓
<input type="text" value="YES"/>	Resets the accumulated operating time of the fan.	

Reset of accumulated operating time

7. Press and hold the [MENU] key for approximately 2 seconds.

Repeat pressing the key until the key-lock setting screen [SE.O 1] appears on the digital display.

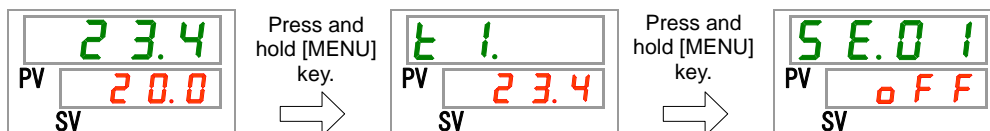

8. Press the [SEL] key 16 times.

Resetting screen of the compressor accumulated operating time appears on the digital display.

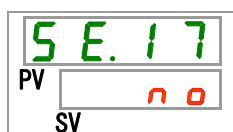

9. Select y e s with [▲] key or [▼] key, and press [SEL] key to enter. Select y e s and press [SEL] key to enter, and the accumulated operating time of the compressor will be reset. The display returns to the main menu.

Table 5.16-4 Reset setting

Set value	Explanation	Default
n o	No data reset.	✓
y e s	Resets the accumulated operating time of the compressor.	

Reset of the accumulated operating time of the dust-proof filter

10. Press and hold the [MENU] key for approximately 2 seconds.

Repeat pressing the key until the key-lock setting screen [SE.O 1] appears on the digital display.

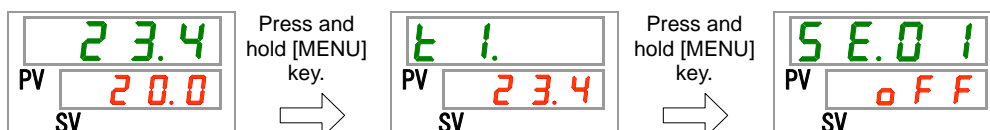

11. Press the [SEL] key 29 times.

Resetting screen of the accumulated operating time of the dust-proof filter appears on the digital display.



12. Select YES with [▲] key or [▼] key, and press [SEL] key to enter. Select YES and press [SEL] key to enter, and the accumulated operating time of the dust-proof filter will be reset. The display returns to the main menu.

Table 5.16-5 Reset setting

Set value	Explanation	Default
no	No data reset.	✓
YES	Resets the accumulated operating time of the dust-proof filter.	

5.17 Warming Up Function

5.17.1 Warming up function

CAUTION



Keep the power supply ON for this function.
This function does not operate when the power is OFF.

This function maintains the circulating fluid temperature to the set warming-up temperature with heat generated by automatically operating the pump in the winter season or at night.

When the time required for increasing the temperature of the circulating fluid needs to be shortened at startup, set this function ON in advance.

- The pump automatically keeps operating until the circulating fluid temperature becomes 2 °C higher than the set warming up temperature.
- The pump automatically stops operating when the circulating fluid temperature becomes 2 °C higher than the set warming up temperature.
- The pump automatically restarts operating when the circulating fluid temperature decreases 2 °C lower than the set warming up temperature.

When the warming up function is set ON, the [RUN] light repeats turning ON for 0.5 seconds and OFF for 3 seconds while it is on standby (when the pump is not operating).

The [RUN] light blinks every 0.3 seconds during the automatic operation of the pump.

The default setting of this function is "OFF".

Note that when the warming up function is ON, the warming up function has a priority over the anti-freezing function, and the anti-freezing function will not be activated.

CAUTION



- This function can be activated only when the power supply is ON and the thermo-chiller is not operating.
- Fully open the valve or manual by-pass valve that is arranged by the user to make it possible for the circulating fluid to circulate when the pump starts automatic operation.
- In extremely cold weather, the circulating fluid temperature may not increase to the set temperature.
- During the automatic operation, the pump does not stop operation even if the "RUN/STOP" key is pressed.
- To stop the pump, turn the power supply OFF or turn this function OFF.

5.17.2 Setting/checking of warming up function

The table below shows the setting items of the warming up function and the default setting.

Table 5.17-1 Set item for warming up function

Display	Item	Content	Default
5 E.2 7	Warming up function	Sets warming up function ON/OFF.	OFF

1. Press and hold the [MENU] key for approximately 2 seconds.

Repeat pressing the key until the key-lock setting screen [5 E.0 1] appears on the digital display.

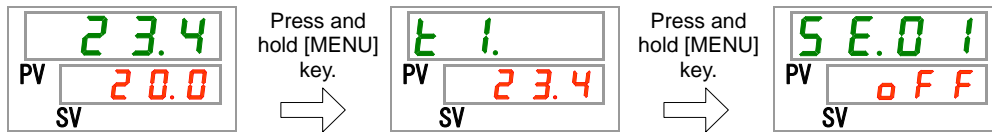

Setting/Checking: Warming up function

2. Press the [SEL] key 26 times.

Setting screen of warming up function is displayed on the digital display.

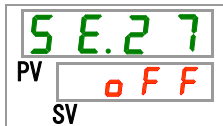

3. Set the warming up function with [▲] key or [▼] key, and press [SEL] key to enter.

Table 5.17-2 Setting of warming up function

Set value	Explanation	Default
OFF	Warming up function OFF	✓
ON	Warming up function ON	

Setting/Checking: Set warming up temperature







4. Press the [SEL] key once.

Setting screen of warming up temperature appears on the digital display.



5. Set the warming up temperature with [▲] key or [▼] key, and press [SEL] key to enter.

Table 5.17-3 Setting of warming up temperature

Set value	Explanation	Default
----	Setting and checking are not available when the warming up function is set OFF.	
Centigrade  to 	Sets the warming up temperature. Setting temperature unit for Centigrade: 0.1 °C	
Fahrenheit  to 	Setting temperature unit for Fahrenheit: 0.1 °F	

6. Press the [MENU] key once.

Returns to the main display (which shows the circulating fluid temperature).

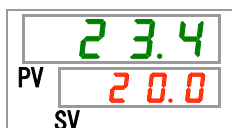

5.18 Anti-Snow Coverage Function

5.18.1 Anti-snow coverage function

CAUTION



**Keep the power supply ON for this function.
This function does not operate when the power is OFF.**

This function prevents snow coverage on the exhaust port on top of the product during the winter time by automatically operating the fan periodically.

When there is a possibility of snow coverage due to changes in the installation or operating environment (e.g. season, weather), set this function ON in advance.

- During the product operation
The fan repeats operation with the maximum rotating cycle for 1 minute and with the normal rotating cycle for 29 minutes.
- During the product stoppage
The fan repeats operation with the maximum rotating cycle for 1 minute and operation stop for 29 minutes.

When the anti-snow coverage function is set ON, this function keeps operating and rotates the fan in the way shown in "During the product stoppage" above even when the compressor and/or pump stops operation due to any alarms.

⚠ CAUTION



- When the amount of snowfall on the product is too large, snow-coverage may not be avoided completely.

⚠ CAUTION



- When the [RUN/STOP] key is pressed during automatic operation of the fan, it is possible to start/stop the product operation, but it is not possible to start/stop the automatic operation of the fan.
- To stop the fan, turn the power supply OFF or turn this function OFF.

5.18.2 Setting/checking of anti-snow coverage function

The table below shows the set item of the anti-snow coverage function and the default setting.

Table 5.18-1 Set item for anti-snow coverage function

Display	Item	Content	Default
SE.29	Anti-snow coverage function	Sets anti-snow coverage function ON/OFF.	OFF

1. Press and hold the [MENU] key for approximately 2 seconds.

Repeat pressing the key until the key-lock setting screen [SE.01] appears on the digital display.

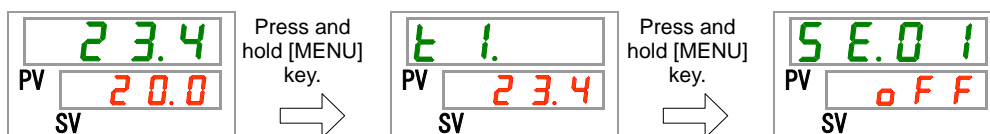

Setting/Checking: Anti-snow coverage function

2. Press the [SEL] key 28 times.

Setting screen of anti-snow coverage function appears on the digital display.

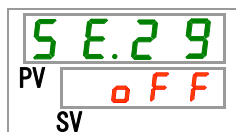

3. Set the anti-snow coverage function with [▲] key or [▼] key, and press “SEL” key to enter.

Table 5.18-2 Anti-snow coverage function setting

Set value	Explanation	Default
OFF	Anti-snow coverage function OFF	✓
ON	Anti-snow coverage function ON	

4. Press the [MENU] key once.

Returns to the main display (which shows the circulating fluid temperature).

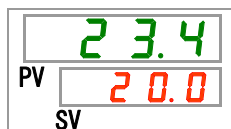

5.19 Alarm Buzzer Sound Setting

5.19.1 Alarm buzzer sound setting

This sets whether a warning sound is made or not when alarm signal is output.

The default setting is buzzer sound ON.

5.19.2 Setting/checking of alarm buzzer sound

The table below shows the set item of the alarm buzzer sound and the default setting.

Table 5.19-1 Set item for alarm buzzer sound

Display	Item	Contents	Default
R 5.0 1	Alarm buzzer sound	Sets alarm buzzer sound ON/OFF.	ON

1. Press and hold the [MENU] key for approximately 2 seconds.

Repeat pressing the key until the alarm buzzer setting screen [R 5.0 1] appears on the digital display.

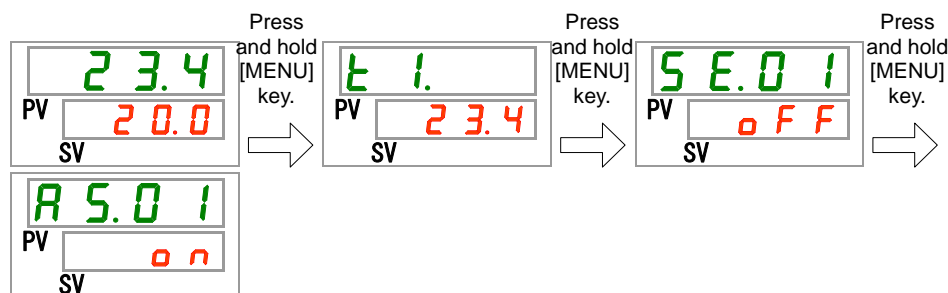

Setting/Checking: Alarm buzzer sound

2. Select alarm buzzer sound ON or OFF with [▲] key or [▼] key, and press [SEL] key to enter.

Table 5.19-2 Alarm buzzer sound setting

Set value	Explanation	Default
o F F	Alarm buzzer sound OFF	
o n	Alarm buzzer sound ON	✓

3. Press the [MENU] key once.

Return to the main display (which shows the circulating fluid temperature).

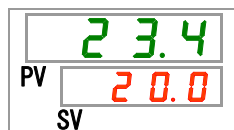

5.20 Alarm Customizing Function

5.20.1 Alarm customizing function

Operation and trigger level when an alarm signal is output can be customized. Perform settings depending on the application of the user. Refer to "Table 5.20-1 Default alarm settings and customizing (1/4)" and "Table 5.20-4 Default alarm settings and customizing (4/4)" for the items that can be customized for each alarm.

1. Alarm operations

A.STP: Operation of compressor, fan, and pump stop *1

A.RUN: Operation of compressor, fan, and pump continues.

P.RUN: Compressor and fan stop operation, and pump continues operation. *1 and 2

OFF: This alarm will not be generated.

- Symbol or each operation

○ : Initial setting

● : Possible to select

- : Impossible to select

*1: Fan when the anti-snow coverage function is ON operates as explained in "5.18 Anti-Snow Coverage Function".

*2: The alarm operations of all the object alarms of the P.RUN cannot be customized individually but collectively.

2. Alarm thresholds and others

This shows the settable range. Settings can be changed from default within this range.

Settings shown with "-" cannot be changed.

Table 5.20-1 Default alarm settings and customizing (1/4)

Code	Alarm name	1. Operation during alarm generation					2. Threshold for alarm generation and other settings*1		
		Display	A.STP	A.RUN	P.RUN	OFF	Display	Default	Settable range
AL01	Low level in tank	A 5.0 2	○	●	-	-	-	-	-
AL02	High circulating fluid discharge temp.	-	○	-	-	-	-	-	-
AL03	Circulating fluid discharge temp. rise	A 5.0 3	●	○	-	●	Set temperature		
							A 5.0 4	40.0 °C (104.0 °F) (----)*2	5.0 to 55.0 °C (41.0 to 131.0 °F)
							Monitoring method		
							A 5.2 1	0	0 to 3
Monitoring start timer									
A 5.2 2	---- (0)*3	0 to 600 minutes							
Range over detection timer									
A 5.2 3	5	5 to 999 seconds							

*1: Values in °F are displayed when SE12 is set to F.

*2: Default value when AS03 is set OFF.

*3: Default value when AS21 is set to either 2 or 3.

Table 5.20-2 Default alarm settings and customizing (2/4)

Code	Alarm name	1. Operation during alarm generation					2. Threshold for alarm generation and other settings*4		
		Display	A.STP	A.RUN	P.RUN	OFF	Display	Default	Settable range
AL04	Circulating fluid discharge temp. drop	R 5.05	●	○	-	●	R 5.06	Set temperature 1.0 °C (33.8 ° F) (----)*5	1.0 to 34.0 °C (33.8 to 93.2 ° F)
							R 5.21	Monitoring method	0 to 3
							R 5.22	Monitoring start timer	----(0)*6 to 600 minutes
							R 5.23	Range over detection timer	5 to 999 seconds
AL05	High circulating fluid return temp.	-	○	-	-	-	-	-	
AL08	Circulating fluid discharge pressure rise	R 5.07	○	●	-	●	R 5.08	Set pressure (Other models) 0.70 MPa (102 PSI) (----)*7	0.03 to 0.70 MPa (4 to 102 PSI)
AL09	Circulating fluid discharge pressure drop	R 5.09	○	●	-	●	R 5.10	Set pressure (Other models) 0.03 MPa (4 PSI) (----)*8	0.03 to 0.70 MPa (4 to 102 PSI)
AL10	High compressor intake temp.	R 5.24	●	-	○	-	-	-	
AL11	Low compressor intake temp.	R 5.24	●	-	○	-	-	-	
AL12	Low super heat temp.	R 5.24	●	-	○	-	-	-	
AL13	High compressor discharge pressure	R 5.24	●	-	○	-	-	-	
AL15	Refrigerant circuit pressure (high pressure side) drop	R 5.24	●	-	○	-	-	-	
AL16	Refrigerant circuit pressure (low pressure side) rise	R 5.24	●	-	○	-	-	-	

*4: Values are shown in °F when the unit is set to F for SE12, and in PSI when the unit is set to PSI for SE13.

*5: Default value when AS05 is set OFF.

*6: Default value when AS21 is set to either 2 or 3.

*7: Default value when AS07 is set OFF.

*8: Default value when AS09 is set OFF.

Table 5.20-3 Default Alarm setting and customizing (3/4)

Code	Alarm name	1. Operation during alarm generation					2. Threshold for alarm generation and other settings		
		Display	A.STP	A.RUN	P.RUN	OFF	Display	Default	Settable range
AL17	Refrigerant circuit pressure (low pressure side) drop	R 5.2 4	●	-	○	-	-	-	-
AL18	Compressor running failure	R 5.2 4	●	-	○	-	-	-	-
AL19	Communication error	R 5.1 1	●	●	-	○	R 5.1 2	---- (30) ^{*9}	Monitoring time 30 to 600 seconds
AL20	Memory error	-	○	-	-	-	-	-	-
AL21	DC line fuse cut	R 5.1 5	○	●	-	-	-	-	-
AL22	Circulating fluid discharge temp. sensor failure	-	○	-	-	-	-	-	-
AL23	Circulating fluid return temp. sensor failure	-	○	-	-	-	-	-	-
AL24	Compressor intake temp. sensor failure	R 5.2 4	●	-	○	-	-	-	-
AL25	Circulating fluid discharge pressure sensor failure	R 5.2 5	○	●	-	●	-	-	*10
AL26	Compressor discharge pressure sensor failure	R 5.2 4	●	-	○	-	-	-	-
AL27	Compressor intake pressure sensor failure	R 5.2 4	●	-	○	-	-	-	-
AL28	Pump maintenance	R 5.2 6	-	●	-	○	-	-	-
AL29	Fan maintenance ^{*10}	R 5.2 7	-	●	-	○	-	-	-
AL30	Compressor maintenance	R 5.2 8	-	●	-	○	-	-	-
AL31	Contact input 1 signal detection	R 5.1 3	○	●	-	●	-	-	-
AL32	Contact input 2 signal detection	R 5.1 4	○	●	-	●	-	-	-
AL37	Compressor discharge temp. sensor failure	R 5.2 4	●	-	○	-	-	-	-
AL38	Compressor discharge temp. rise	R 5.2 4	●	-	○	-	-	-	-

*9: Default value when AS11 is set to either A.STP or A.RUN.

*10: AL.08 and AL.09 do not generate when AS.25 is set to A.RUN.

Table 5.20-4 Default alarm settings and customizing (4/4)

Code	Alarm name	1. Operation during alarm generation					2. Threshold for alarm generation and other settings		
		Display	A.STP	A.RUN	P.RUN	OFF	Display	Default	Settable range
AL40	Dust-proof filter maintenance	R 5.2 9	-	●	-	○	R 5.3 1	Set time	
							500 h	1 to 9999 h	
AL41	Power stoppage	R 5.3 0	○	-	-	●	-	-	
AL42	Compressor standby	-	-	○	-	-	-	-	
AL43	Fan failure	R 5.2 4	●	-	○	-	-	-	
AL45	Compressor over current	R 5.2 4	●	-	○	-	-	-	
AL47	Pump over current	-	○	-	-	-	-	-	
AL50	Incorrect phase error	-	○	-	-	-	-	-	
AL51	Phase board over current	-	○	-	-	-	-	-	

⚠ CAUTION



When the operation setting for the alarm that has been set to A.STP as default is changed to A.RUN or OFF, the product operation will not stop even when the alarm is generated. Keeping operation of the product even after an alarm is generated may cause failure. Remove the causes of the alarm as soon as possible.
 Be sure to remove the cause of the alarm immediately after the alarm occurred. Otherwise it may cause a malfunction of the product.

5.20.2 Setting and checking of the alarm customizing function

The table below shows the set items of the alarm customizing function and the default settings.

Table 5.20-5 Default settings of the alarm customizing function (1/3)

Display	Content	Alarm		Change	Default *1
		Code	Alarm name		
A 5.02	Operation setting when "Low level in tank" alarm is generated	AL01	Low level in tank	Product operation while the alarm is being generated	A.STP
A 5.03	Operation setting when "Detection temp. for the circulating fluid discharge temp. rise" alarm is generated	AL03	Circulating fluid discharge temp. rise	Product operation while the alarm is being generated	A.RUN
A 5.04	Threshold temperature setting for "Detection temp. for the circulating fluid discharge temp. rise" alarm			Alarm threshold	40.0 °C (104.0 °F) (----)
A 5.05	Operation setting when "Detection temp. for the circulating fluid discharge temp. drop" alarm is generated	AL04	Circulating fluid discharge temp. drop	Product operation while the alarm is being generated	A.RUN
A 5.06	Threshold temperature setting for "Detection temp. for the circulating fluid discharge temp. drop" alarm			Alarm threshold	1.0 °C (33.8 °F) (----)
A 5.07	Operation setting when "Circulating fluid discharge pressure rise" alarm is generated	AL08	Circulating fluid discharge pressure rise	Product operation while the alarm is being generated	ASTP
A 5.08	Threshold pressure setting for "Circulating fluid discharge pressure rise" alarm			Alarm threshold	0.70 MPa (102 PSI) (----)
A 5.09	Operation setting when "Circulating fluid discharge pressure decrease" alarm is generated	AL09	Circulating fluid discharge pressure drop	Product operation while the alarm is being generated	A.STP
A 5.10	Threshold pressure setting for "Circulating fluid discharge pressure decrease" alarm			Alarm threshold	0.03 MPa (4 PSI) (----)
A 5.11	Operation setting when "Communication error" alarm is generated	AL19	Communication error	Product operation while the alarm is being generated	OFF
A 5.12	Threshold monitoring time setting for "Communication error"			Alarm threshold	---- (30)

*1: See "Table 5.20-1 Default alarm settings and customizing (1/4) to (4/4)" for more details of the default settings.

Table 5.20-6 Default settings of the alarm customizing function (2/3)

Display	Content	Alarm		Change	Default*1
		Code	Alarm name		
A5.13	Setting function for "Contact input signal 1" detection	AL31	Contact input 1 signal detection	Product operation while the alarm is being generated	A.STP
A5.14	Setting function for "Contact input signal 2" detection	AL32	Contact input 2 signal detection	Product operation while the alarm is being generated	A.STP
A5.15	Operation setting when "DC line fuse cut" alarm is generated	AL21	DC line fuse cut	Product operation while the alarm is being generated	A.STP
A5.21	Temperature alarm monitoring mode setting	AL03	Circulating fluid discharge temp. rise	Monitoring method	0
		AL04	Circulating fluid discharge temp. drop		
A5.22	Monitoring start timer	AL03	Circulating fluid discharge temp. rise	Alarm will not be generated during the set period of time after starting operation. Alarm monitoring starts when the set time has passed.	---- (0)
		AL04	Circulating fluid discharge temp. drop		
A5.23	Range over detection timer	AL03	Circulating fluid discharge temp. rise	An alarm will not be generated for the set period of time after the circulating fluid discharge temperature becomes out of the set range.	5
		AL04	Circulating fluid discharge temp. drop		
A5.24	Compressor stop alarm	AL10	High compressor intake temp.	Product operation while the alarm is being generated	P.RUN
		AL11	Low compressor intake temp.		
		AL12	Low super heat temp.		
		AL13	High compressor discharge pressure		
		AL15	Refrigerant circuit pressure (high pressure side) drop		
		AL16	Refrigerant circuit pressure (low pressure side) rise		
		AL17	Refrigerant circuit pressure (low pressure side) drop		
		AL18	Compressor running failure		
		AL24	Compressor intake temp. sensor failure		
		AL26	Compressor discharge pressure sensor failure		
		AL27	Compressor intake pressure sensor failure		
		AL37	Compressor discharge temp. sensor failure		
		AL38	Compressor discharge temp. rise		
AL43	Fan failure				
AL45	Compressor over current				

*1: See "Table 5.20-1 Default alarm settings and customizing (1/4) to (4/4)" for more details of the default settings

Table 5.20-7 Default settings of the alarm customizing function (3/3)

Display	Content	Alarm	Alarm	Default	Display*1
		Code	Alarm name		
A5.25	Operation setting when "Circulating fluid discharge pressure sensor error" alarm is generated	AL25	Circulating fluid discharge pressure sensor failure	Product operation while the alarm is being generated	A.STP
A5.26	Operation setting during maintenance of the pump	AL28	Pump maintenance	Product operation while the alarm is being generated	OFF
A5.27	Operation setting during maintenance of the fan	AL29	Fan maintenance	Alarm operation	OFF
A5.28	Operation setting during maintenance of the compressor	AL30	Compressor maintenance	Product operation while the alarm is being generated	OFF
A5.29	Operation setting during maintenance of the dust-proof filter	AL40	Dust-proof filter maintenance	Product operation while the alarm is being generated	OFF
A5.30	Operation setting at a time of operation restoration after power failure	AL41	Power stoppage	Product operation while the alarm is being generated	A.STP
A5.31	Monitoring time for maintenance of dust-proof filter	AL40	Dust-proof filter maintenance	Alarm threshold	---- (500 h)

*1: See "Table 5.20-1 Default alarm settings and customizing (1/4) to (4/4)" for more details of the default settings .

1. Press and hold the [MENU] key for approximately 2 seconds.

Repeat pressing the key until the alarm buzzer sound setting screen [R5.01] appears on the digital display.

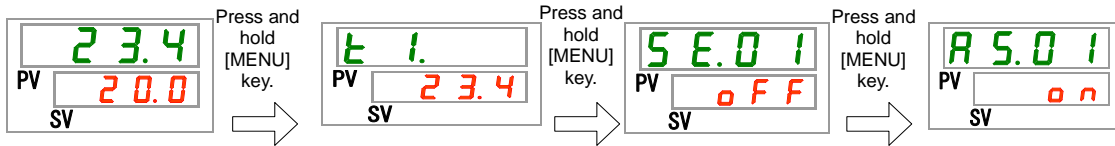

Setting/Checking: Operation setting when "Low level in tank" alarm is generated

2. Press the [SEL] key once.

Operation setting screen when "Low level in tank" alarm is generated appears on the digital display.

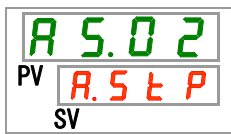

3. Set the product operation when "Low level in tank" alarm is generated with [▲] key or [▼] key, and press [SEL] key to enter.

Table 5.20-8 Product operation setting when "Low level in tank" alarm is generated

Set value	Explanation	Default
R.r U n	Operation continues when this alarm is generated.	
R.5 t P	Operation stops when this alarm is generated.	✓

Setting/Checking: Operation setting when "Circulating fluid discharge temp. rise" alarm is generated

4. Press the [SEL] key once.

Operation setting screen when "Circulating fluid discharge temp. rise" alarm is generated appears on the digital display.



5. Set the product operation when "Circulating fluid discharge temp. rise" alarm is generated with [▲] key or [▼] key, and press [SEL] key to enter.

Table 5.20-9 Operation setting when "Circulating fluid discharge temp. rise" alarm is generated

Set value	Explanation	Default setting
o F F	This alarm is not detected.	
A.r U n	Operation continues when this alarm signal is generated.	✓
A.S t P	Operation is stopped when this alarm signal is generated.	

Setting/Checking: Threshold temperature setting for "Detection temp. for the circulating fluid discharge temp. increase" alarm

6. Press the [SEL] key once.

Threshold detecting temperature setting screen for "Circulating fluid discharge temp. rise" alarm generation appears on the digital display.



7. Set the threshold detection temperature for "Circulating fluid discharge temp. rise" alarm generation with [▲] key or [▼] key, and press [SEL] key to enter.

Table 5.20-10 Threshold detection temperature setting for "Circulating fluid discharge temp. rise" alarm generation

Set value	Explanation	Default
- - - -	Setting/checking of the alarm is impossible when the "Circulating fluid discharge temp. rise" alarm is set OFF.	
Centigrade 5.0 to 55.0	Sets threshold detecting temperature for "Circulating fluid discharge temp. rise" alarm.	40.0
Fahrenheit 41.0 to 131.0	Setting temperature unit for Centigrade: 0.1 °C Setting temperature unit for Fahrenheit: 0.1 °F	104.0

Setting/Checking: Operation setting when "Circulating fluid discharge temp. drop" alarm is generated

8. Press the [SEL] key once.

Operation setting screen when "Circulating fluid discharge temp. drop" alarm is generated appears on the digital display.

Set the product operation when "Circulating fluid discharge temp. drop" alarm is generated with [▲] key or [▼] key, and press [SEL] key to enter.

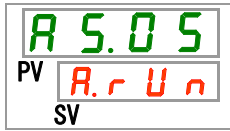

9. Set the product operation when "Circulating fluid discharge temp. drop" alarm is generated with [▲] key or [▼] key, and press [SEL] key to enter.

Table 5.20-11 Operation setting when "Circulating fluid discharge temp. drop" alarm is generated

Set value	Explanation	Default
o F F	This alarm is not detected.	
R.r U n	Operation continues when this alarm is generated.	✓
R.S t P	Operation stops when this alarm is generated.	

Setting/Checking: Threshold detecting temperature setting for "Circulating fluid discharge temp. drop" alarm generation

10. Press the [SEL] key once.

Threshold detecting temperature setting screen for "Circulating fluid discharge temp. drop" alarm generation appears on the digital display.



11. Set the threshold detecting temperature for "Circulating fluid discharge temp. drop" alarm generation with [▲] key or [▼] key, and press [SEL] key to enter.

Table 5.20-12 Threshold detecting temperature for "Circulating fluid discharge temp. drop" alarm

Set value	Explanation	Default
- - - -	Setting/checking of the alarm is impossible when the "Circulating fluid discharge temp. drop" alarm is set OFF.	
Centigrade 1.0 to 34.0	Sets threshold detecting temperature for "Circulating fluid discharge temp. drop" alarm	1.0
Fahrenheit 33.8 to 93.2	Setting temperature unit for Centigrade: 0.1 °C Setting temperature unit for Fahrenheit: 0.1 °F	33.8

Setting/Checking: Operation setting when "Circulating fluid discharge pressure rise" alarm is generated

12. Press the [SEL] key once.

Operation setting screen when "Circulating fluid discharge pressure rise" alarm is generated appears on the digital display.



13. Set the product operation when "Circulating fluid discharge pressure rise" alarm is generated with [▲] key or [▼] key, and press [SEL] key to enter.

Table 5.20-13 Operation setting when "Circulating fluid discharge pressure rise" alarm is generated

Set value	Explanation	Default
OFF	This alarm is not detected.	
R. r U n	Operation continues when this alarm is generated.	
R. S t P	Operation stops when this alarm is generated.	✓

Setting/Checking: Threshold pressure setting for "Circulating fluid discharge pressure rise" alarm

14. Press the [SEL] key once.

Threshold detecting pressure setting screen for "Circulating fluid discharge pressure rise" alarm generation appears on the digital display.



15. Set the threshold detection pressure for "Circulating fluid discharge pressure rise" alarm generation with [▲] key or [▼] key, and press [SEL] key to enter.

Table 5.20-14 Threshold detecting pressure setting for "Circulating fluid discharge pressure rise" alarm

Set value	Explanation	Default
----	Setting/checking of the alarm is impossible when the "Circulating fluid discharge pressure rise" alarm is set OFF.	
MPa 0.03 to 0.70	Sets threshold detection pressure for "Circulating fluid discharge pressure rise" alarm generation.	0.70
PSI 4 to 102	Pressure setting unit for MPa: 0.01 MPa Pressure setting unit for PSI: 1 PSI	102

Setting/Checking: Operation setting when "Circulating fluid discharge pressure drop" alarm is generated

16. Press the [SEL] key once.

Operation setting screen when "Circulating fluid discharge pressure drop" alarm is generated appears on the digital display.



17. Set the product operation when "Circulating fluid discharge pressure drop" alarm is generated with [▲] key or [▼] key, and press [SEL] key to enter.

Table 5.20-15 Operation setting when "Circulating fluid discharge pressure drop" alarm is generated

Set value	Explanation	Default
o F F	This alarm is not detected.	
R. r U n	Operation continues when this alarm is generated.	
R.5 t P	Operation stops when this alarm is generated.	✓

Setting/Checking: Threshold pressure setting for "Circulating fluid discharge pressure drop" alarm

18. Press the [SEL] key once.

Threshold detecting pressure setting screen for "Circulating fluid discharge pressure drop" alarm generation appears on the digital display.



19. Set the threshold detection pressure for "Circulating fluid discharge pressure drop" alarm generation with [▲] key or [▼] key, and press [SEL] key to enter.

Table 5.20-16 Threshold detecting pressure setting for "Circulating fluid discharge pressure drop" alarm generation

Set value	Explanation	Default
- - - -	Setting/checking of the alarm is impossible when the "Circulating fluid discharge pressure drop" alarm is set OFF.	
MPa 0.03 to 0.70	Sets threshold detection pressure for "Circulating fluid discharge pressure drop" alarm generation. Pressure unit for MPa: 0.01 MPa Pressure unit for PSI: 1 PSI	0.03
PSI 4 to 102		4

Setting/Checking: Operation setting when "Communication error" alarm is generated

20. Press the [SEL] key once.

Operation setting screen when "Communication error" alarm is generated appears on the digital display.

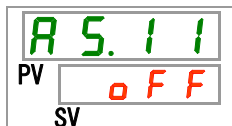

21. Set operation when "Communication error" alarm is generated with [▲] key or [▼] key, and confirm by pressing "SEL".

Table 5.20-17 Operation setting when "Communication error" alarm is generated

Set value	Explanation	Default
OFF	This alarm is not detected.	✓
Run	Operation continues when this alarm is generated.	
Stop	Operation stops when this alarm is generated.	

Setting/Checking: Threshold monitoring time setting for "Communication error"

22. Press the [SEL] key once.

Monitoring time setting screen for "Communication error" alarm appears on the digital display.



23. Set monitoring time for "Communication error" alarm with [▲] key or [▼] key, and confirm by pressing "SEL".

Table 5.20-18 Monitoring time for "Communication error" alarm setting

Set value	Explanation	Default
---	Setting/checking of the alarm is impossible when the "AS11 Communication error" alarm is set OFF.	
30 to 600	Monitoring time for "Communication error" is set. Setting unit: 1 second	30

Setting/Checking: Operation setting when "Contact input 1 signal detection" alarm is generated

24. Press the [SEL] key once.

Operation setting screen when "Contact input 1 signal detection" alarm is generated appears on the digital display.

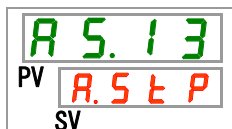

25. Set the product operation when "Contact input 1 signal detection" alarm is generated with [▲] key or [▼] key, and press [SEL] key to enter.

Table 5.20-19 Operation setting when "Contact input 1 signal detection" alarm is generated

Set value	Explanation	Default
OFF	This alarm is not detected.	
Run	Operation continues when this alarm is generated.	
STOP	Operation stops when this alarm is generated.	✓

Setting/Checking: Operation setting when "Contact input 2 signal detection" alarm is generated

26. Press the [SEL] key once.

Operation setting screen when "Contact input 2 signal detection" alarm is detected appears on the digital display.

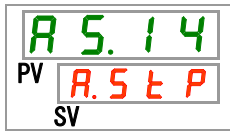

27. Set the product operation when "Contact input 2 signal detection" alarm is generated with [▲] key or [▼] key, and press [SEL] key to enter.

Table 5.20-20 Operation setting when "Contact input 2 signal detection" alarm is generated

Set value	Explanation	Default
OFF	This alarm is not detected.	
Run	Operation continues when this alarm is generated.	
STOP	Operation stops when this alarm is generated.	✓

Setting/Checking: Operation when "DC line fuse cut" alarm is generated

28. Press the [SEL] key once.

Operation setting screen when "DC line fuse cut" alarm is generated appears on the digital display.



29. Set the product operation when "DC line fuse cut" alarm is generated with [▲] key or [▼] key, and press [SEL] key to enter.

Table 5.20-21 Operation setting when "DC line fuse cut" alarm is generated

Set value	Explanation	Default
A.r U n	Operation continues when this alarm is generated.	
A.S t P	Operation stops when this alarm is generated.	✓

Setting/Checking: Temperature alarm monitoring method

30. Press the [SEL] key once.

Setting screen of the temperature alarm monitoring method appears on the digital display.

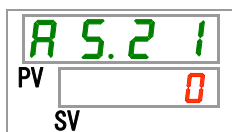

31. Set temperature alarm monitoring method with [▲] key or [▼] key, and press [SEL] key to enter.

Table 5.20-22 Setting of temperature alarm monitoring method

Set value	Item	Explanation	Default
0	Continuous monitoring	Alarm monitoring starts at the same time as the product is turned ON. When the ambient temperature is out of the range between the temperatures set for AS.04 and AS.06, AL.03 or AL.04 may be generated at the same time when the product is turned ON.	✓
1	Automatic monitoring	When the circulating fluid temperature is outside of the alarm threshold range at the time of operation start, the alarm will not be generated until the temperature comes inside the alarm threshold range.	
2	Monitoring start timer	Alarm will not be generated until it reaches the time set for the AS.22 "Monitoring start timer" after the operation starts. Alarm monitoring starts when the set time has passed.	
3	Automatic monitoring + Monitoring start timer	Alarm will not be generated until it reaches the time set for the AS.22 "Monitoring start timer" after the operation starts. Alarm monitoring starts when the set time has passed. When the circulating fluid temperature enters the alarm threshold range before it reaches the set time, the alarm monitoring will be started at that time.	

* Settings of this function and example of alarm generating timing for 5.20.3 "Setting of temperature alarm monitoring method and generation timing".

Setting/Checking: Monitoring start timer

32. Press the [SEL] key once.

Setting screen of the monitoring start timer is displayed on the digital display.

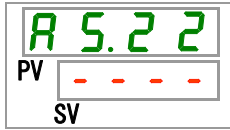

33. Set monitoring start timer with the [▲] key or the [▼] key, and press [SEL] key to enter.

Table 5.20-23 Setting of the monitoring start timer

Set value	Explanation	Default
---	Setting and checking are impossible when "0: Continuous monitoring" or "1: Automatic monitoring" is selected for the setting of AS21 "Temperature alarm monitoring method".	✓
0 to 600	Sets the time when alarm monitoring starts. Setting unit is 1 minute.	0

* Settings of this function and example of alarm generating timing for 5.20.3 "Setting of temperature alarm monitoring method and generation timing".

Setting/Checking: Range over detection timer

34. Press the [SEL] key once.

Setting screen of the range over detection timer is displayed on the digital display.

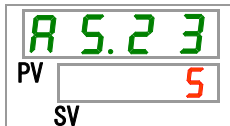

35. Set range over detection timer with the [▲] key or [▼] key, and press [SEL] key to enter.

Table 5.20-24 Setting of the range over detection timer

Set value	Explanation	Default
5 to 999	Sets time before the alarm is generated after the alarm is generated. Setting unit: 1 second	5

* Settings of this function and example of alarm generating timing for 5.20.3 "Setting of temperature alarm monitoring method and generation timing".

5.20.3 Setting of temperature alarm monitoring method and alarm generation timing

Examples of temperature alarm monitoring method setting and alarm generation timing are shown below.

■ When "**Automatic monitoring**" is selected;

- [1] Circulating fluid temperature when starting operation: Approximately 20 °C
- [2] Circulating fluid set temperature: 15 °C
- [3] "AS.21: Temperature alarm monitoring method": Select "Automatic monitoring".
("----" (invalid setting) will be shown for "AS.22: Monitoring start timer".)
- [4] "AS.04: Detection temp. for the circulating fluid discharge temp. rise": Set to "16 °C".
- [5] "AS.06: Detection temp. for the circulating fluid discharge temp. drop": Set to "14 °C".
- [6] "AS.23: Range over detection timer ": Set to "600 sec".

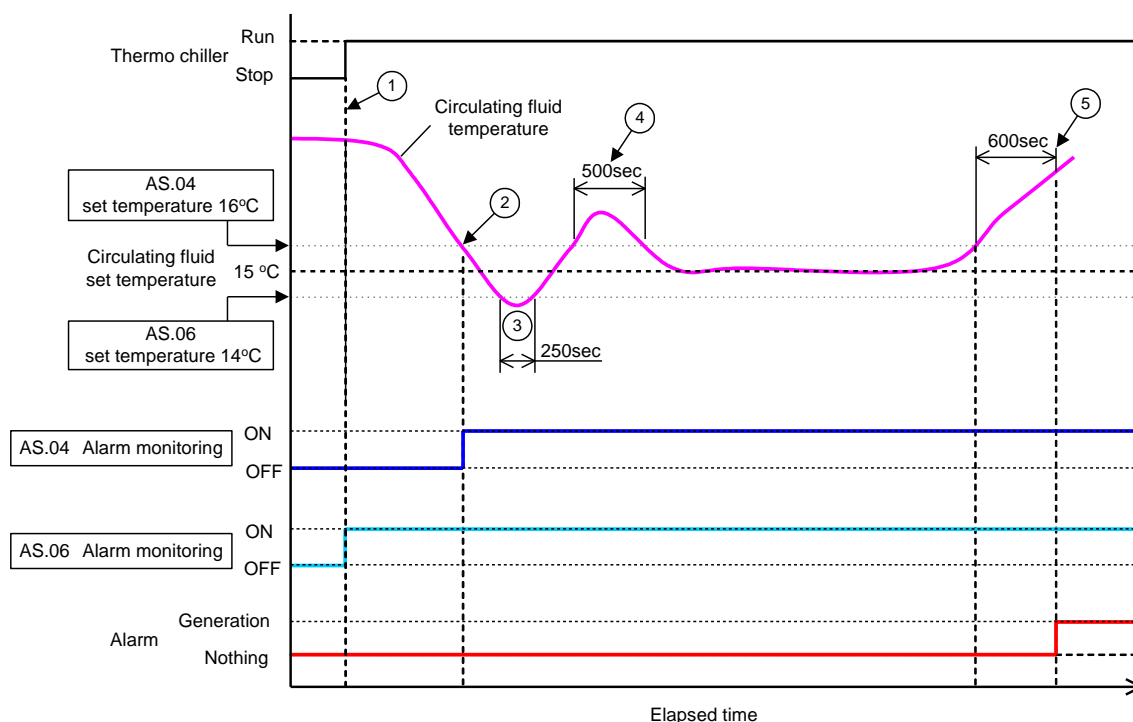

Fig 5-3: Alarm generation timing

■ Alarm generation timing

- Status (1): Temperature alarm monitoring starts by starting the chiller operation. As the circulating fluid temperature at this time is 20 °C, "AS.06" starts alarm monitoring at the same time as the operation start.
- Status (2): The circulating fluid temperature becomes within the set range of "AS.04", and starts "AS.04" alarm monitoring.
- Status (3): The circulating fluid temperature exceeds the threshold of "AS.06", but the alarm will not be generated as it has returned within the 600 second range of the "AS.23: Range over detecting timer".
- Status (4): The circulating fluid temperature exceeds the threshold of "AS.04", but the alarm will not be generated as it has returned within the 600 second range of the "AS.23: Range over detecting timer".
- Status (5): Alarm "AL03: Circulating fluid discharge temp. rise" will be generated after 600 seconds that is set for the "AS.23: Range over detection timer" after the circulating fluid temperature exceeds the threshold of "AS.04".

■ When "Automatic monitoring + Monitoring start timer" is selected

- [1] Circulating fluid temperature when starting operation: Approximately 20 °C
- [2] Circulating fluid set temperature: 15 °C
- [3] "AS.21: Temperature alarm monitoring method": Select "Automatic monitoring + Monitoring start timer".
- [4] "AS.22: Monitoring start timer": Set it to "50 min".
- [5] "AS.04: Detection temp. for the circulating fluid discharge temp. rise": Set to "16 °C".
- [6] "AS.06: Detection temp. for the circulating fluid discharge temp. drop": Set to "14 °C".
- [7] "AS.23: Range over detection timer": Set to "600 sec".

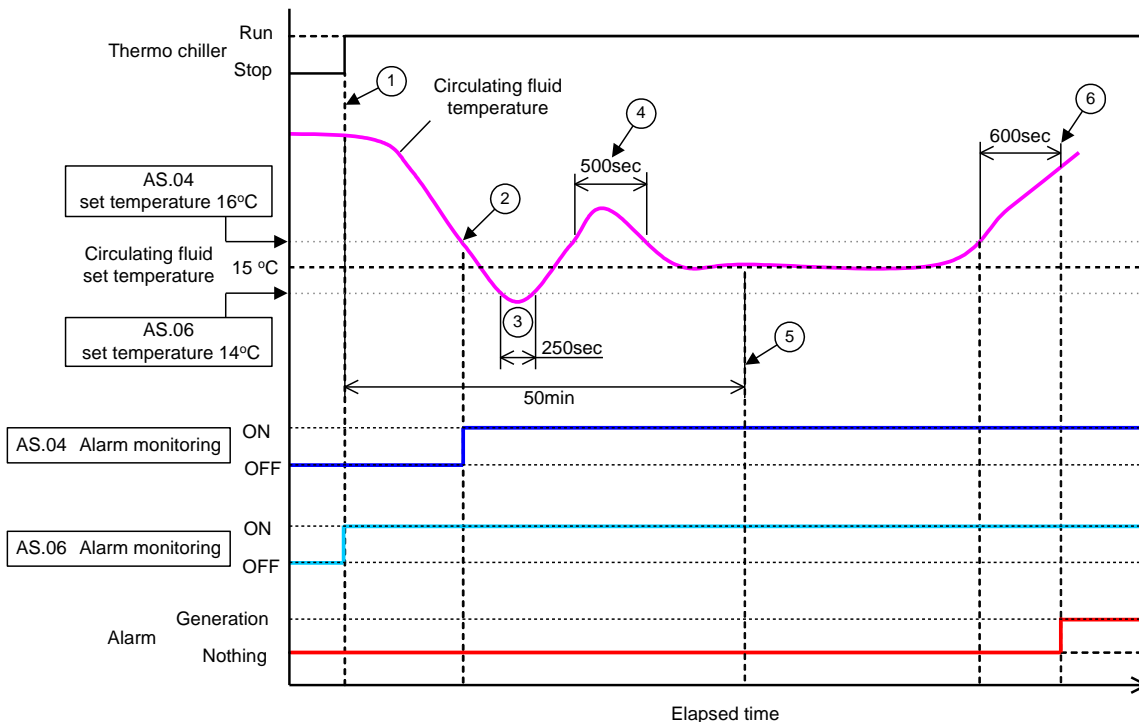

Fig 5-4: Alarm generation timing

■ Alarm generation timing

- Status (1): Start operation of the chiller. As the circulating fluid temperature is within the set range of "AS.06", "AS.06" alarm monitoring starts.
- Status (2): The circulating fluid temperature becomes within the set range of "AS.04". "AS.04" alarm monitoring starts.
- Status (3): The circulating fluid temperature exceeds the threshold of "AS.06", but the alarm will not be generated as it has returned within the 600 sec range of the "AS.23: Range over detecting timer".
- Status (4): The circulating fluid temperature exceeds the threshold of "AS.04", but the alarm will not be generated as it has returned within the 600 sec range of the "AS.23: Range over detecting timer".
- Status (5): 50 minutes passes after starting operation. Alarm monitoring has started. It shows that the "50 min" setting does not influence the alarm monitoring under these conditions.
- Status (6): Alarm will be generated after 600 seconds that is set for "AS.23: Range over detection timer" after the circulating fluid temperature exceeds the threshold of "AS.04".

Setting/Checking: Operation when compressor related alarms are generated

36. Press the [SEL] key once.

Setting screen of the product operation when compressor related alarms are generated appears on the digital display.

37. Set the product operation when the compressor related errors are generated with the [▲] key or [▼] key. Refer to "Table 5.20-26 Operation setting of compressor and pump when the pump related alarms are generated", and press [SEL] key to enter.

Batch setting of the operation of compressor and pump is executed for all the alarms shown in "Table 5.20-25: Compressor related alarms".

Table 5.20-25 Compressor related alarms

Code	Alarm name
AL10	High compressor intake temp.
AL11	Low compressor intake temp.
AL12	Low super heat temp.
AL13	High compressor discharge pressure
AL15	Refrigerant circuit pressure (high pressure side) drop
AL16	Refrigerant circuit pressure (low pressure side) rise
AL17	Refrigerant circuit pressure (low pressure side) drop
AL18	Compressor running failure
AL24	Compressor intake temp. sensor failure
AL26	Compressor discharge pressure sensor failure
AL27	Compressor intake pressure sensor failure
AL37	Compressor discharge temp. sensor failure
AL38	Compressor discharge temp. rise
AL43	Fan failure
AL45	Compressor over current

Table 5.20-26 Operation setting of compressor and pump when the pump related alarms are generated

Set value	Explanation	Default
P.r U n	Operation of only the compressor stops when these alarms are generated.	✓
S t o p	Operation of both the compressor and pump stops when these alarms are generated.	

Setting/Checking: Operation setting when "Circulating fluid discharge pressure sensor error" alarm is generated

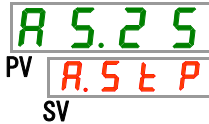

38. Press the [SEL] key once.

Operation setting screen when "Circulating fluid discharge pressure sensor failure" alarm is generated appears on the digital display.



39. Set the product operation when "Circulating fluid discharge pressure sensor failure" alarm is generated with [▲] key or [▼] key, and press [SEL] key to enter.

Table 5.20-27 Operation setting when the "Circulating fluid discharge pressure sensor failure" alarm is generated

Set value	Explanation	Default
	This alarm signal is not detected. While this setting is ON, [ALARM] light on the operation panel keeps blinking with the light ON for 0.5 seconds and OFF for 3 seconds.	
	Operation continues when this alarm is generated.	
	Operation stops when this alarm is generated.	✓

Setting/Checking: Operation setting when "Pump maintenance" alarm is generated

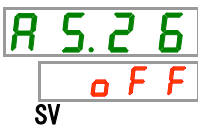

40. Press the [SEL] key once.

Operation setting screen when "Pump maintenance" alarm is generated appears on the digital display.



41. Set the product operation when "Pump maintenance" alarm is generated with [▲] key or [▼] key, and press [SEL] key to enter.

Table 5.20-28 Operation setting when "Pump maintenance" alarm is generated

Set value	Explanation	Default
	This alarm is not detected.	✓
	Operation continues when this alarm is generated.	

 Setting/Checking: Operation setting when "Fan maintenance" alarm is generated

42. Press the [SEL] key once.

Operation setting screen when "Fan maintenance" alarm is generated appears on the digital display.

SV

43. Set the product operation when "Fan maintenance" alarm is generated with [▲] key or [▼] key, and press [SEL] key to enter.

Table 5.20-29 Operation setting when "Fan maintenance" alarm is generated

Set value	Explanation	Default
OFF	This alarm signal is not detected.	✓
R.r U n	Operation continues when this alarm signal is generated.	

 Setting/Checking: Operation setting when "Compressor maintenance" alarm is generated

44. Press the [SEL] key once.

Operation setting screen when "Compressor maintenance" alarm is generated appears on the digital display.

SV

45. Set the product operation when "Compressor maintenance" alarm is generated with [▲] key or [▼] key, and press [SEL] key to enter.

Table 5.20-30 Operation setting when "Compressor maintenance" alarm is generated

Set value	Explanation	Default
OFF	This alarm is not detected.	✓
R.r U n	Operation continues when this alarm is generated.	

Setting/Checking: Operation setting when "Dust-proof filter maintenance" alarm is generated

46. Press the [SEL] key once.

Operation setting screen when "Dust-proof filter maintenance" alarm is generated appears on the digital display.

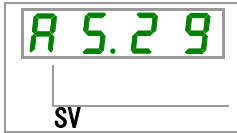

47. Set the product operation when "Dust-proof filter maintenance" alarm is generated with [▲] key or [▼] key, and press [SEL] key to enter.

Table 5.20-31 Operation setting when "Dust-proof filter maintenance" alarm is generated

Set value	Explanation	Default
o F F	This alarm is not detected.	
R. r U n	Operation continues when this alarm is generated.	✓

Setting/Checking: Operation setting when "Power stoppage" alarm is generated

48. Press the [SEL] key once.

Operation setting screen when "Power stoppage" alarm is generated appears on the digital display.

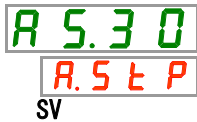

49. Set the product operation when "Power stoppage" alarm is generated with [▲] key or [▼] key, and press [SEL] key to enter.

Table 5.20-32 Operation setting when "Power stoppage" alarm is generated

Set value	Explanation	Default
o F F	This alarm is not detected.	
R. S t P	Operation continues when this alarm is generated.	✓

Setting/Checking: Monitoring time for maintenance of dustproof filter

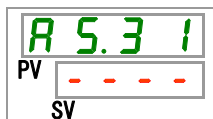

50. Press the [SEL] key once.

Setting screen of the monitoring time before "Dust-proof filter maintenance" alarm is generated is displayed on the digital display.

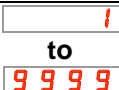

51. Set the monitoring time before the "Dust-proof filter maintenance" alarm is generated with [▲] key or [▼] key, and press [SEL] key to enter.

Table 5.20-33 Monitoring time setting before "Dust-proof filter maintenance" alarm is generated

Set value	Explanation	Default
	When the AS29 "Dust-filter maintenance" alarm is set OFF, setting and checking of the monitoring time are impossible.	✓
	Sets time before the alarm is generated. Setting unit: 1 hour	

5.21 Communication Function

5.21.1 Communication function

Contact input/output and serial communication can be performed.

Refer to the Operation Manual Communication Function for more details.

5.21.2 Setting/checking of communication function

The table below shows the set items of the communication function and default settings.

Table 5.21-1 Set items of communication function

Display	Item	Contents	Default setting
[Co.01]	Communication mode	Sets communication mode.	LOC
[Co.02]	Serial communication protocol	Sets serial communication protocol.	MDBS
[Co.03]	Communication specification	Sets serial communication standard.	485
[Co.04]	RS-485 terminal unit	Sets the terminal unit for RS-485.	OFF
[Co.05]	Mo db us	Slave address	Sets slave address.
[Co.06]		Slave address	Sets slave address.
[Co.07]	Simple communication protocol	Communication speed	Sets communication speed.
[Co.08]		Slave address	Sets slave address.
[Co.09]		Communication speed	Sets communication speed.
[Co.10]		BCC	Sets error detection code.
[Co.11]		Data length	Sets data length.
[Co.12]		Parity check	Sets parity check.
[Co.13]		Stop bit length	Sets stop bit length
[Co.14]		Response delay time	Sets time delay before sending a response message.
[Co.15]		Communication range	Sets communication range.
[Co.16]		Contact input signal 1	Sets contact input signal 1.
[Co.17]	Contact input signal 1 type	Sets input type of the contact input signal 1.	
[Co.18]	Contact input signal 1 delay timer for reading	Sets the contact input signal 1 delay timer for reading.	
[Co.19]	Contact input signal 1 OFF detection timer	Sets the OFF detection timer of the contact input signal 1.	
[Co.20]	Contact input signal 2	Sets contact input signal 2.	
[Co.21]	Contact input signal 2 type	Sets the input type of the contact input signal 2.	
[Co.22]	Contact input signal 2 delay timer for reading	Sets the contact input signal 2 delay timer for reading.	
[Co.23]	Contact input signal 2 OFF detection timer	Sets the OFF detection timer of the contact input signal 2.	
[Co.24]	Contact output signal 1 function	Sets the output signal function of the contact output signal 1.	
[Co.25]	Contact output signal 1 operation	Sets the output signal operation of the contact output signal 1.	
[Co.26]	Contact output signal 1 selected alarm	Sets the selected alarm for the contact output signal 1.	
[Co.27]	Contact output signal 2 function	Sets the output signal function of the contact output signal 2.	
[Co.28]	Contact output signal 2 operation	Sets the output signal operation of the contact output signal 2.	
[Co.29]	Contact output signal 2 selected alarm	Sets the alarm selected for the contact output signal 2.	
[Co.30]	Contact output signal 3 function	Sets the output signal function of the contact output signal 3.	
[Co.31]	Contact output signal 3 operation	Sets the output signal operation of the contact output 3.	
[Co.31]	Contact output signal 3 selected alarm	Sets the alarm selected for the contact output signal 3.	

*1: Default when CO02 is set to PRO1 or PRO2.

*2: Default when CO15 is set to SW-A or SW-B.

*3: Default when CO19 is set to SW-A or SW-B.

*4: Default when CO23 is set to A.SEL.

*5: Default when CO26 is set to A.SEL.

*6: Default when CO29 is set to A.SEL.

Setting/Checking: Communication mode

1. Press and hold the [MENU] key for approximately 2 seconds.

Repeat pressing the key until the communication mode setting screen [Co.01] appears on the digital display.

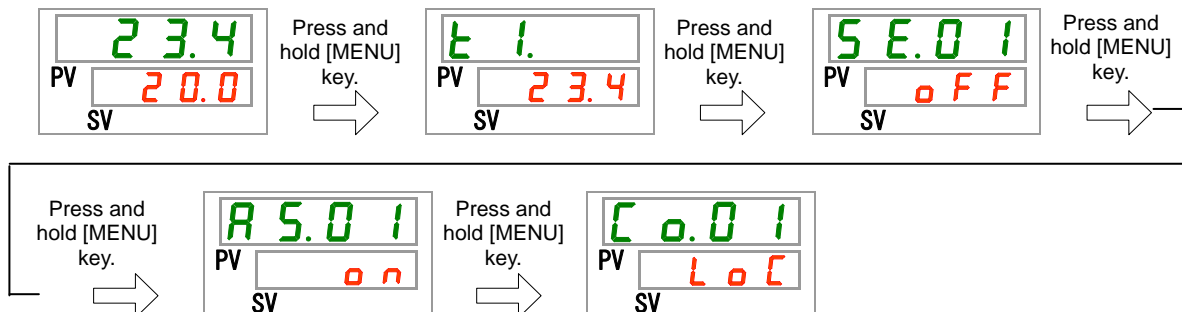

2. Select a communication mode with [▲] key or [▼] key, and press [SEL] key to enter.

Table 5.21-2 Setting of communication mode

Set value	Explanation	Default
Loc	Sets LOCAL mode. (Operation and setting can be performed on the operation panel.)	✓
dio	Sets DIO mode.*1 (The product is operated with contact input/output.)	
SEr	Sets SERIAL mode.*2 (Operation and setting are performed by serial communication.)	

*1: When the contact input signal 1 is “external switch signal”, it is not possible to set to “DIO mode”.

*2: When the serial protocol is “simple communication protocol 2” and the contact input 1 is “external switch signal” or contact input 2 is “remote signal”, it is not possible to set to “SERIAL mode”.

Setting/Checking: Serial communication protocol

3. Press the [SEL] key once.

Setting screen of serial communication protocol appears on the digital display.

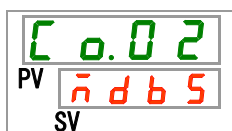

4. Select a serial communication protocol with [▲] key or [▼] key, and press [SEL] key to enter.

Table 5.21-3 Setting of serial communication protocol

Set value	Explanation	Default
Modbus	MODBUS protocol	✓
Pro1	Simple communication protocol 1	
Pro2	Simple communication protocol 2*1	

*1: When the contact input signal 2 is set to "remote signal", it is not possible to set to "simple communication protocol 2".

Setting/Checking: Communication specification

5. Press the [SEL] key once.

Setting screen of the communication specification is displayed on the digital display.

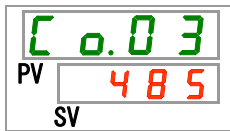

6. Select communication specification with [▲] key or [▼] key, and press [SEL] key to enter.

Table 5.21-4 Setting of communication specification

Set value	Explanation	Default
232C	RS-232C standard	
485	RS-485 standard	✓

Setting/Checking: Terminal for RS-485

7. Press the [SEL] key once.

Setting screen of terminal for RS-485 is displayed on the digital display.

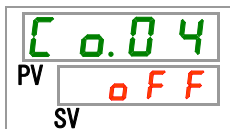

8. Perform a setting of terminal for RS-485 with [▲] key or [▼] key, and press [SEL] key to enter.

Table 5.21-5 Setting of terminal for RS-485

Set value	Explanation	Default
OFF	No terminal	✓
ON	Terminal is set.	

Setting/Checking: Slave addresses (MODBUS)

9. Press the [SEL] key once.

Setting screen of slave addresses (MODBUS) is displayed on the digital display.



10. Set slave addresses (MODBUS) with [▲] key or [▼] key, and press [SEL] key to enter.

Table 5.21-6 Slave address settings

Set value	Explanation	Default
---	Setting/checking is possible only when the serial protocol is MODBUS.	
1 to 99	Slave address setting for MODBUS Setting range: 1 to 99	1

Setting/Checking: Communication speed (MODBUS)

11. Press the [SEL] key once.

Setting screen of the communication speed (MODBUS) is displayed on the digital display.



12. Set communication speed (MODBUS) with [▲] key or [▼] key, and press [SEL] key to enter.

Table 5.21-7 Communication speed setting

Set value	Explanation	Default
---	Setting and checking is possible only when the serial protocol setting is MODBUS.	
9.6	9600bps	
19.2	19200bps	✓

Setting/Checking: Settings of slave addresses (simple communication protocol)

13. Press the [SEL] key once.

Setting screen of slave addresses (simple communication protocol) is displayed on the digital display.



14. Set slave addresses (simple communication protocol) with [▲] key or [▼] key, and press [SEL] key to enter.

Table 5.21-8 Setting of slave addresses

Set value	Explanation	Default
----	Setting/checking is possible only when the serial protocol setting is simple communication protocol.	
1 to 99	Setting of slave addresses for simple communication protocol Setting range: 1 to 99	1

Setting/Checking: Communication speed (simple communication protocol)

15. Press the [SEL] key once.

Setting screen of communication speed (simple communication protocol) is displayed on the digital display.

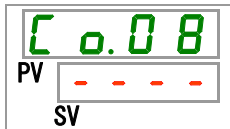

16. Set communication speed (serial communication protocol) with [▲] key or [▼] key, and press [SEL] key to enter.

Table 5.21-9 Communication speed setting

Set value	Explanation	Default
----	Setting/checking is possible only when the serial protocol setting is simple communication protocol.	
1.2	1200bps	
2.4	2400bps	
4.8	4800bps	
9.6	9600bps	✓
19.2	19200bps	

Setting/Checking: BCC (simple communication protocol)

17. Press the [SEL] key once.

Setting screen of BCC (simple communication protocol) is displayed on the digital display.

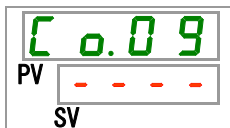

18. Set BCC (simple communication protocol) with [▲] key or [▼] key, and press [SEL] key to enter.

Table 5.21-10 BCC setting

Set value	Explanation	Default
----	Setting/checking is possible only when the serial protocol setting is simple communication protocol.	
o F F	Without BCC	
o n	With BCC	✓

Setting/Checking: Data length (simple communication protocol)

19. Press the [SEL] key once.

Setting screen of data length (simple communication protocol) is displayed on the digital display.



20. Set data length (simple communication protocol) with [▲] key or [▼] key, and press [SEL] key to enter.

Table 5.21-11 Data length setting

Set value	Explanation	Default
----	Setting/checking is possible only when the serial protocol setting is simple communication protocol.	
7 b i t	7 bit	
8 b i t	8 bit	✓

Setting/Checking: Parity check (simple communication protocol)

21. Press the [SEL] key once.

Setting screen of parity check (simple communication protocol) is displayed on the digital display.



22. Perform setting for parity check (simple communication protocol) with [▲] key or [▼] key, and press [SEL] key to enter.

Table 5.21-12 Parity check setting

Set value	Explanation	Default
----	Setting/checking is possible only when the serial protocol setting is simple communication protocol.	
non	No parity check	✓
odd	Parity check with odd number	
Even	Parity check with even number	

Setting/Checking: Stop bit (simple communication protocol)

23. Press the [SEL] key once.

Setting screen of stop bit (simple communication protocol) is displayed on the digital display.

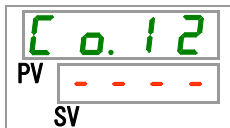

24. Set stop bit (simple communication protocol) with [▲] key or [▼] key, and press [SEL] key to enter.

Table 5.21-13 Stop bit setting

Set value	Explanation	Default
----	Setting/checking is possible only when the serial protocol setting is simple communication protocol.	
1bit	1 bit	
2bit	2 bit	✓

Setting/Checking: Response delay time (simple communication protocol)

25. Press the [SEL] key once.

Setting screen of response delay time (simple communication protocol) is displayed on the digital display.



26. Set response delay time (simple communication protocol) with [▲] key or [▼] key, and press [SEL] key to enter.

Table 5.21-14 Setting of response delay time

Set value	Explanation	Default
----	Setting/checking is possible only when the serial protocol setting is simple communication protocol.	
0 to 250	Setting of response delay time Setting range: 0 to 250 ms	0

Setting/Checking: Communication range (simple communication protocol)

27. Press the [SEL] key once.

Setting screen of communication range (simple communication protocol) is displayed on the digital display.



28. Set communication range (simple communication protocol) with [▲] key or [▼] key, and press [SEL] key to enter.

Table 5.21-15 Setting of communication range

Set value	Explanation	Default
----	Setting/checking is possible only when the serial protocol setting is simple communication protocol.	
r0	Only reading is available	
rH	Reading and writing are available	✓

Setting/Checking: Contact input signal 1

29. Press the [SEL] key once.

Setting screen of contact input signal 1 is displayed on the digital display.

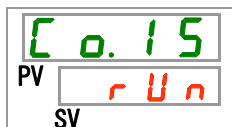

30. Perform setting for the contact input signal 1 with [▲] key or [▼] key, and press [SEL] key to enter.

Table 5.21-16 Setting for contact input signal 1

Set value	Explanation	Default
o F F	No signal input	
r U n	Run/Stop signal input	✓
S H _ A	External switch signal input (N.O. type) ^{*1,*2}	
S H _ b	External switch signal input (N.C. type) ^{*1,*2}	

*1: When the setting of the communication mode is "DIO mode", "External switch signal" cannot be set.

*2: When the setting of the communication mode is "SEIRAL mode" and the protocol setting is "Simplified communication protocol 2", "External switch signal" cannot be set.

Setting/Checking: Contact input signal 1 type

31. Press the [SEL] key once.

Setting screen of contact input signal 1 type is displayed on the digital display.

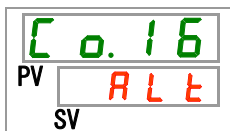

32. Select the contact input signal 1 type with [▲] key or [▼] key, and press [SEL] key to enter.

Table 5.21-17 Setting of contact input signal 1 type

Set value	Explanation	Default
- - - -	Setting/checking is not available when contact input signal 1 setting is OFF.	
A L t	Alternate signal	✓
n t	Momentary signal ^{*1}	

*1: This can be set only when the contact input signal 1 is set to "Run/Stop signal input".

Setting/Checking: Contact input signal 1 delay timer for reading

33. Press the [SEL] key once.

Setting screen of contact input signal 1 delay timer is displayed on the digital display.



34. Set time delay for the contact input signal 1 delay timer for reading with [▲] key or [▼] key, and press [SEL] key to enter.

Table 5.21-18 Setting of time delay for contact input signal delay timer for reading

Set value	Explanation	Default
----	Setting/checking is possible only when the contact input signal 1 is set to external switch signal input (N.O. type or N.C. type).	
0 to 300	Setting of the contact input signal 1 delay timer of reading Setting range: 0 to 300 seconds	0

Setting/Checking: Contact input signal 1 OFF detection timer

35. Press the [SEL] key once.

Setting screen of contact input signal 1 OFF detection timer is displayed on the digital display.

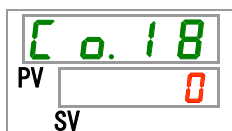

36. Set threshold time for the contact input signal 1 OFF detection timer with [▲] key or [▼] key, and press [SEL] key to enter.

Table 5.21-19 Threshold time setting for contact input signal 1 OFF detection timer

Set value	Explanation	Default
----	Setting/checking is possible only when the contact input signal 1 is set to external switch signal input (N.O. type or N.C. type).	
0 to 10	Setting of the contact input signal 1 OFF detection timer Setting range: 0 to 10 seconds	0

Setting/Checking: Contact input signal 2

37. Press the [SEL] key once.

Setting screen of contact input signal 2 is displayed on the digital display.

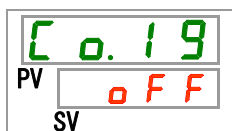

38. Perform setting of the contact input signal 2 with [▲] key or [▼] key, and press [SEL] key to enter.

Table 5.21-20 Setting of the contact input signal 2

Set value	Explanation	Default
o F F	No signal input	✓
r U n	Run/stop signal input	
S H - A	External switch signal input (N.O. type)	
S H - b	External switch signal input (N.C. type)	
r n t	Remote signal input*1	

*1: When the serial communication protocol is set to "Simplified communication protocol 2", it is not possible to set to "Remote signal".

Setting/Checking: Contact input signal 2 type

39. Press the [SEL] key once.

Setting screen of contact input signal 2 type is displayed on the digital display.

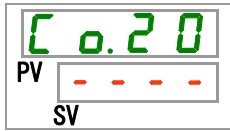

40. Select contact input signal 2 type with [▲] key or [▼] key, and press [SEL] key to enter.

Table 5.21-21 Setting of the contact input signal 2 type

Set value	Explanation	Default
- - - -	Setting/checking are not available when contact input signal 2 setting is OFF.	
A L t	Alternate signal	✓
r n t	Momentary signal*1	

*1: This can be set only when the contact input signal 2 is set to "Run/Stop signal input" or "Remote signal".

Setting/Checking: Contact input signal 2 delay timer of reading

41. Press the [SEL] key once.

Setting screen of contact input signal 2 delay timer is displayed on the digital display.

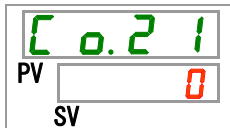

42. Set time delay for the contact input signal 2 delay timer for reading with [▲] key or [▼] key, and press [SEL] key to enter.

Table 5.21-22 Setting of time delay for the contact input signal 2 delay timer for reading

Set value	Explanation	Default
	Setting/checking is possible only when the contact input signal 2 is set to external switch signal input (N.O. or N.C.).	
	Setting of the contact input signal 2 delay timer for reading Setting range: 0 to 300 seconds	

Setting/Checking: Contact input signal 2 OFF detection timer

43. Press the [SEL] key once.

Setting screen of contact input signal 2 OFF detection timer is displayed on the digital display.

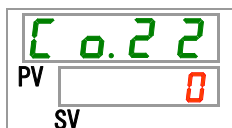

44. Set threshold time for the contact input signal 2 OFF detection timer with [▲] key or [▼] key, and press [SEL] key to enter.

Table 5.21-23 Time setting for contact input signal 2 OFF detection timer

Set value	Explanation	Default
	Setting/checking is possible only when the contact input signal 2 is set to external switch signal input (N.O. or N.C.).	
	Setting of the contact input signal 2 OFF detection timer Setting range: 0 to 10 seconds	

Setting/Checking: Contact output signal 1 function

45. Press the [SEL] key once.

Setting screen of contact output signal 1 function is displayed on the digital display.

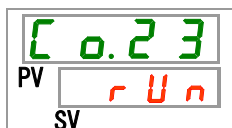

46. Select a function with [▲] key or [▼] key, and press [SEL] to enter.

Table 5.21-24 Setting for the contact output signal 1

Set value	Explanation	Default
OFF	No signal output	
run	Operation status signal output	✓
rn̄t	Remote status signal output	
rdy	Ready completion (TEMP READY) signal output	
ASTP	Operation stop alarm signal output	
ArUn	Operation continuation alarm signal output	
ALn̄	Alarm status signal output	
ASEL	Selected alarm status signal output	
ont̄n̄	Operation start timer setting status signal output	
of̄t̄n̄	Operation stop timer setting status signal output	
PrSt	Operation restoration from power failure setting status signal output	
F.P.	Anti-freezing setting status signal output	
INP1	Pass through signal output of the contact input signal 1	
INP2	Pass through signal output of the contact input signal 2	
WARn̄	Warming up function setting status signal output	
Snob	Anti-snow coverage function setting status signal output	

Setting/Checking: Operation of the contact output signal 1

47. Press the [SEL] key once.

Setting screen of the contact output signal 1 operation is displayed on the digital display.

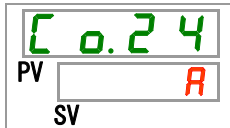

48. Select operation of the contact output signal 1 with [▲] key or [▼] key, and press [SEL] key to enter.

Table 5.21-25 Setting of operation of the contact output signal 1

Set value	Explanation	Default
A	N.O. type	✓
b	N.C. type	

Setting/Checking: Selected alarm for contact output signal 1

49. Press the [SEL] key once.

Setting screen of selected alarm of the contact output signal 1 is displayed on the digital display.

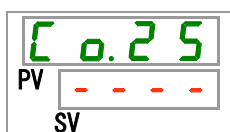

50. Set the alarm selected for the contact output signal 1 with [▲] key or [▼] key, and press [SEL] key to enter.

Table 5.21-26 Setting of the alarm selected for the contact output signal 1

Set value	Explanation	Default
----	Setting/checking is possible only when the contact output signal 1 is set to the selected alarm status signal output.	
AL01 to AL51	Setting of the selected alarm Setting range: AL.01 to AL.51	AL01

Setting/Checking: Contact output signal 2 function

51. Press the [SEL] key once.

Setting screen of the contact output signal 2 function is displayed on the digital display.

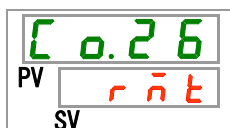

52. Select a function with [▲] key or [▼] key, and press [SEL] to enter.

Table 5.21-27 Setting for the contact output signal 2

Set value	Explanation	Default
o F F	No signal output	
r U n	Operation status signal output	
r n t	Remote status signal output	✓
r d y	Ready completion (TEMP READY) signal output	
A. S t P	Operation stop alarm signal output	
A. r U n	Operation continuation alarm signal output	
A L n	Alarm status signal output	
A. S E L	Selected alarm status signal output	
o n t n	Operation start timer setting status signal output	
o F. t n	Operation stop timer setting status signal output	
P. r S t	Operation restoration from power failure setting status signal output	
F. P.	Anti-freezing setting status signal output	
I n P 1	Pass through signal output of the contact input signal 1	
I n P 2	Pass through signal output of the contact input signal 2	
W A r n	Warming up function setting status signal output	
S n o B	Anti-snow coverage function setting status output	

Setting/Checking: Contact output signal 2 operation

53. Press the [SEL] key once.

Setting screen of the contact output signal 2 operation is displayed on the digital display.

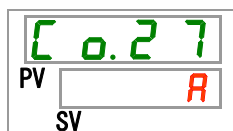

54. Set the operation type of the contact output signal 2 with [▲] key or [▼] key, and press [SEL] key to enter.

Table 5.21-28 Operation type setting for the contact output signal 2

Set value	Explanation	Default
A	N.O. type	✓
b	N.C. type	

Setting/Checking: Selected alarm for contact output signal 2

55. Press the [SEL] key once.

Setting screen of selected alarm of the contact output signal 2 is displayed on the digital display.

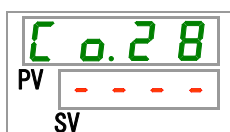

56. Set the alarm selected for the contact output signal 2 with [▲] key or [▼] key, and press [SEL] key to enter.

Table 5.21-29 Setting of the alarm selected for the contact output signal 2

Set value	Explanation	Default
----	Setting/checking is possible only when the contact output signal 2 is set to the selected alarm status signal output.	
AL.01 to AL.51	Setting of the selected alarm Setting range: AL.01 to AL.51	AL.01

Setting/Checking: Contact output signal 3 function

57. Press the [SEL] key once.

Setting screen of the contact output signal 3 function is displayed on the digital display.

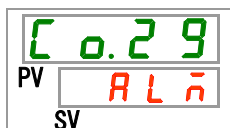

58. Select a function for the contact output signal 3 with [▲] key or [▼] key, and press [SEL] key to enter.

Table 5.21-30 Function setting for the contact output signal 3

Set value	Explanation	Default
OFF	No signal output	
rUn	Operation status signal output	
rñt	Remote status signal output	
rdY	Ready completion (TEMP READY) signal output	
AStP	Operation stop alarm signal output	
A.rUn	Operation continuation alarm signal output	
ALñ	Alarm status signal output	✓
ASEL	Selected alarm status signal output	
ontñ	Operation start timer setting status signal output	
of.tñ	Operation stop timer setting status signal output	
P.rSt	Operation restoration from power failure setting status signal output	
F.P.	Anti-freezing setting status signal output	
INP1	Pass through signal output of the contact input signal 1	
INP2	Pass through signal output of the contact input signal 2	
WARñ	Warming up function setting status signal output	
SnoB	Anti-snow coverage function setting status signal output	

Setting/Checking: Operation of the contact output signal 3

59. Press the [SEL] key once.

Setting screen of the contact output signal 3 operation is displayed on the digital display.

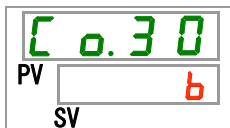

60. Set the operation type of the contact output signal 3 with [▲] key or [▼] key, and press [SEL] key to enter.

Table 5.21-31 Operation setting for the contact output signal 3

Set value	Explanation	Default
A	N.O. type	
b	N.C. type	✓

Setting/Checking: Selected alarm for contact output signal 3

61. Press the [SEL] key once.

Setting screen of the selected alarm of the contact output signal 3 is displayed on the digital display.



62. Set the alarm selected for the contact output signal 3 with [▲] key or [▼] key, and press [SEL] key to enter.

Table 5.21-32 Setting of an alarm selected for the contact output signal 3

Set value	Explanation	Default
----	Setting/checking is possible only when the contact output signal 3 is set to the selected alarm status signal output.	
AL01 to AL51	Setting of the selected alarm Setting range: AL.01 to AL.51	AL01

63. Press the [MENU] key once.

Returns to the main display (which shows the circulating fluid temperature).

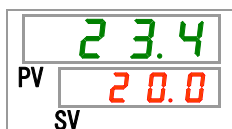

Chapter 6 Alarm Notification and Troubleshooting

6.1 Alarm Notification

- The product makes notification in the order shown below when any alarm is generated. The [ALARM] light blinks.
- The alarm buzzer sounds.
- The alarm number is displayed in the PV window on the digital display.
- Contact signal of the contact input/output communication is output. Refer to the Operation Manual Communication Function for more details.
- It is possible to read the alarm status using serial communication. Refer to the Operation Manual Communication Function for more details.
- This product has two types of operation depending on the alarm being generated.

During the product operation, some of the alarms stop the product operation and some of them do not stop the operation with the alarm being generated.

Refer to the “Table 6-1 to 6-3 Alarm codes and troubleshooting”. When the operation stops due to the alarm, it is not possible to restart the operation until the alarm is reset.

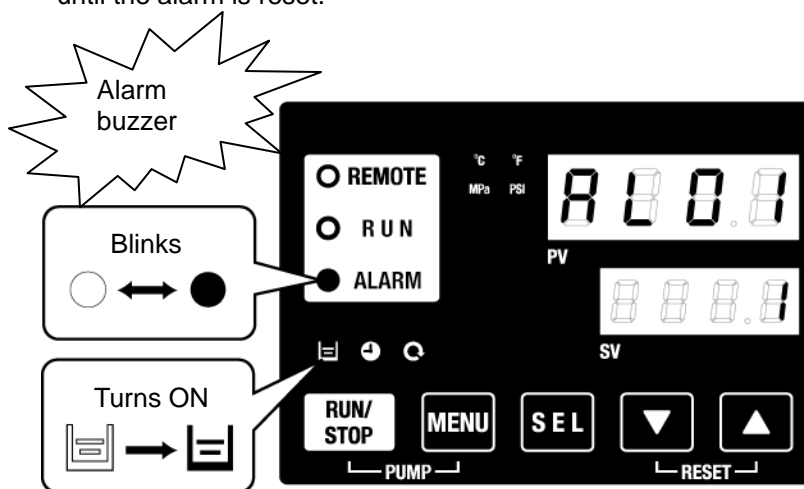

* [ALARM] light turns ON only when “AL01 Low level in tank” alarm is being generated.

- When multiple alarms are generated, the alarm codes are displayed one by one by pressing the [SEL] key
Alarm with the number "1" in the SV window on the digital display is the latest alarm. The alarm with the largest number is the alarm that was generated first.

[Example of display]

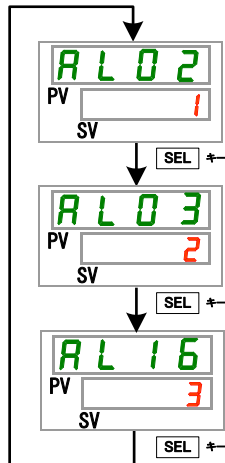

When the alarms are generated in the order of AL16, AL03, and AL02:

The alarm code displayed on the operation panel is AL02. AL03 and AL16 are displayed by pressing the [SEL] key.

When AL16 being is displayed, the SV window displays "3". In this example, AL16 has the largest number. This means AL16 is the alarm that was generated first.

6.2 Alarm Buzzer Stop

An alarm buzzer sounds to notify when any alarms are generated. How to stop the alarm buzzer is explained below.

- Confirm that the alarm display is shown. The alarm buzzer can be stopped only on this screen.
- Press the [▼] and [▲] keys simultaneously, and the alarm buzzer stops.

Tips

- Alarm buzzers can be set not to make sound. Refer to “5.19 Alarm Buzzer Sound Setting”. It is not necessary to follow the buzzer stop instructions when the alarm buzzer sound is set to OFF.
- If this procedure is performed when the cause of the alarm has been eliminated before stopping the alarm buzzer, the alarm will be reset at the same time.

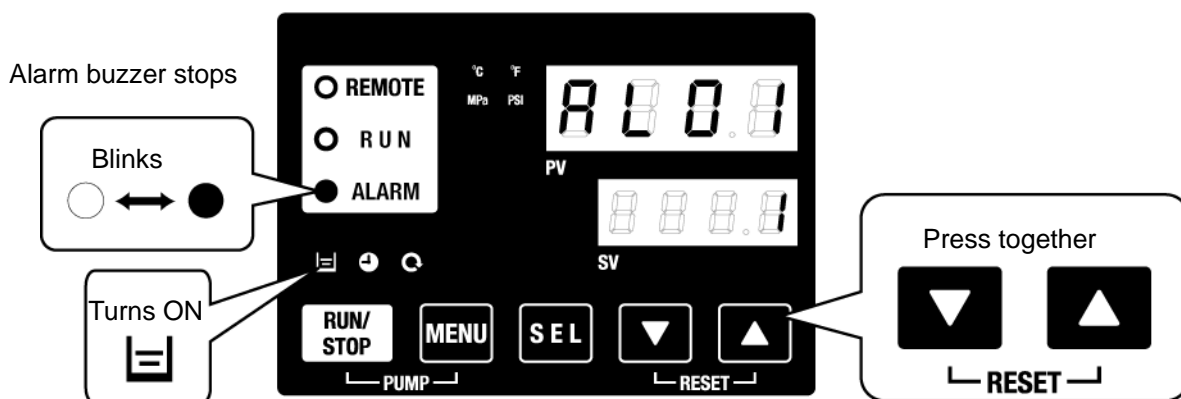

* [Light icon] light turns ON only when “AL01 Low level in tank” alarm is being generated.

6.3 Troubleshooting

6.3.1 Alarm contents, causes, and troubleshooting

Troubleshooting method varies depending on which alarm has been generated. Refer to "Table 6-1 to 6-3 Alarm codes and troubleshooting".

Instructions to reset the alarms after eliminating the causes of the alarms explained below.

- Confirm that the alarm display is shown. Alarms can only be reset on this screen.
- Press [▼] and [▲] keys down simultaneously.
- The alarm is reset, and the [ALARM] light turns OFF.

The operation panel displays the circulating fluid temperature and the set circulating fluid temperature.

Contact signal output for contact input/output communication stops. (Refer to the Operation Manual Communication Function for more details.)

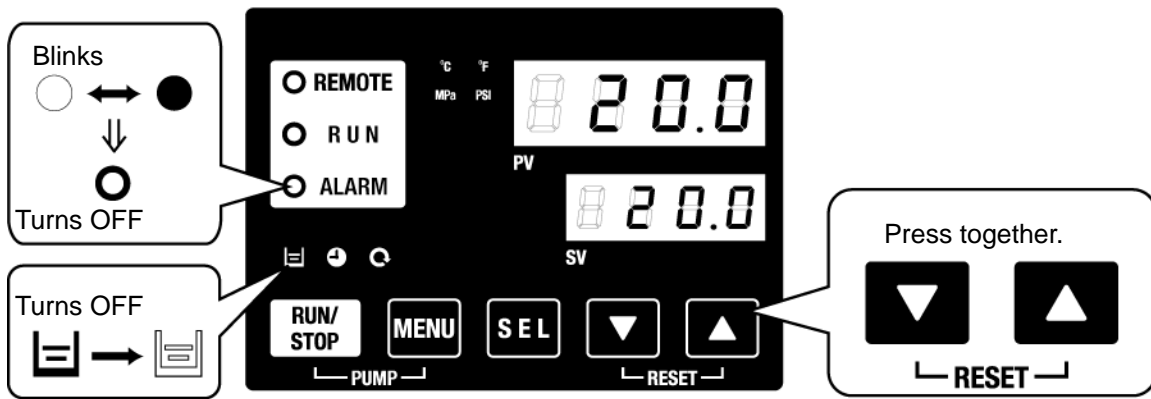

* [PUMP] light turns ON only when "AL01 Low level in tank" alarm is being generated.

- Operation status of the thermo-chiller during the alarm is being generated can be customized by the user. Refer to "5.20 Alarm Customizing Function" for more details.

- A.STP : Compressor, pump, and fan stop operation.
- A.RUN : Compressor, pump, and fan continue operation.
- P.RUN : Compressor and fan stop operation, and pump continues operation.
- OFF : This alarm will not be generated.

Table 6-1 Alarm codes and troubleshooting (1/3)

Alarm code	Alarm name	Operation status (Default)	Cause/Countermeasure (Press the reset key after eliminating the cause.)
AL01	Low level in tank	A.STP	Fluid level shown by the fluid level meter has fallen. Supply or add circulating fluid.
AL02	High circulating fluid discharge temp.	A.STP	<ul style="list-style-type: none"> · - Check that the ambient temperature, facility water, and heat load satisfy the specifications, and that the circulating fluid flow rate is more than the minimum flow rate. · Circulating fluid flow rate can be checked with the check "monitor menu. · Change the set value of A5.04 to be appropriate. · Wait until the circulating fluid temperature goes down.
AL03	Circulating fluid discharge temp. rise	A.RUN	
AL04	Circulating fluid discharge temp. drop	A.RUN	<ul style="list-style-type: none"> · Check that the circulating fluid temperature supplied to the tank is within the specified range. · Change the set value of A5.06 to be appropriate.
AL05	High circulating fluid return temp.	A.STP	<ul style="list-style-type: none"> · Check that the circulating fluid flows. · Check that the heat load is within the specified range.
AL08	Circulating fluid discharge pressure rise	A.STP	Check that there is no bending, collapse, or clogging with the external piping. "EEEE" shown on the PI display in the check monitor menu indicates short-circuit or broken wire of the pressure sensor in the circulating fluid circuit. Ask for the service for the pressure sensor..
AL09	Circulating fluid discharge pressure drop	A.STP	Restart the thermo-chiller and check if the pump runs. In case of displaying EEEE on the PI display of the main display and check monitor menu, the pressure sensor of the circulating fluid circuit has a malfunction. Ask the service.
AL10	High compressor intake temp.	P.RUN	<ul style="list-style-type: none"> · Check the circulating fluid temperature returning to the thermo-chiller. · Check that the heat load is within the specified range.
AL11	Low compressor intake temp.	P.RUN	<ul style="list-style-type: none"> · Check that the circulating fluid flows. · Use a 15% ethylene glycol aqueous solution when operating with a set temperature lower than 10 °C.
AL12	Low super heat temp.	P.RUN	
AL13	High compressor discharge pressure	P.RUN	Check that the ambient temperature, facility water, and heat load satisfy the specifications.
AL15	Refrigerant circuit pressure (high pressure side) drop	P.RUN	Refrigerant circuit failed. Ask for service for the refrigerant circuit.
AL16	Refrigerant circuit pressure (low pressure side) rise	P.RUN	Check that the ambient temperature, facility water, and heat load satisfy the specifications.
AL17	Refrigerant circuit pressure (low pressure side) drop	P.RUN	<ul style="list-style-type: none"> · Check that the circulating fluid flows. · It is possible that refrigerant is leaking. Ask for the service.
AL18	Compressor running failure	P.RUN	Leave it for 10 minutes, and then restart the thermo-chiller. Check if the pump operates.
AL19	Communication error	OFF	Try to send the request message again.

Table 6-2 Alarm codes and troubleshooting (2/3)

Code	Alarm name	Alarm operation (Default)	Cause / Remedy (Press the reset key after eliminating the cause.)	
AL20	Memory error	A.STP	Controller failure. Ask for service for the controller.	
AL21	DC line fuse cut	A.STP	Fuse for the power supply output of the contact input/output connector has blown. ·Ask for service for the fuse of the output voltage circuit. ·Check that there is no incorrect wiring and the current load is within the specified range.	
AL22	Circulating fluid discharge temp. sensor failure	A.STP	Short-circuit or broken wire of the temperature sensor. Ask for service for the temperature sensor.	
AL23	Circulating fluid return temp. sensor failure	A.STP		
AL24	Compressor intake temp. sensor failure	P.RUN		
AL25	Circulating fluid discharge pressure sensor failure	A.STP	Short-circuit or broken wire of the pressure sensor of the circulating fluid circuit. EEEE is displayed on the PI display of the main display and check monitor display. Ask for service for the pressure sensor.	
AL26	Compressor discharge pressure sensor failure	P.RUN	Short-circuit or broken wire of the pressure sensor of the refrigerant circuit. Ask for service for the pressure sensor.	
AL27	Compressor intake pressure sensor failure	P.RUN		
AL28	Pump maintenance	OFF	Notices of the periodical maintenances. Ask for services of the pump, fan and/or compressor. Reset the operation cumulated time for each alarm with the menu SE.15 , SE.16 , or SE.17 after having the service.	Every 20,000 hours
AL29 *2	Fan maintenance	OFF		Every 30,000 ours
AL30	Compressor maintenance	OFF		Every 30,000 hours
AL31	Contact input 1 signal detection	A.STP	Contact input has been detected.	
AL32	Contact input 2 signal detection	A.STP		
AL37	Compressor discharge temp. sensor failure	P.RUN	Short-circuit or broken wire of the temperature sensor. Ask for service for the temperature sensor.	
AL38	Compressor discharge temp. rise	P.RUN	Check that the ambient temperature, facility water, and heat load satisfy the specifications.	

Table 6-3 Alarm codes troubleshooting (3/3)

Code	Alarm name	Alarm operation *1 (Default)	Cause / Remedy (Press the reset key after eliminating the cause.)
AL40	Dust-proof filter maintenance	OFF	<p>Notice of the periodical maintenance. Clean the dust-proof filter. Reset the operation cumulated time for the alarm with the menu SE30 after cleaning the filter. This alarm can be OFF with the menu R529.</p> <p>1 to 9999 hours (AS.31)</p>
AL41	Power stoppage	A.STP	<p>Power supply has been stopped during the product operation. Restart the power supply after checking.</p>
AL42	Compressor standby	A.RUN	<p>Waiting for the compressor to be ready for operation. Wait for a while. The alarm will be reset automatically after starting operation.</p>
AL43	Fan failure	P.RUN	<p>Check that there is no power failure such as ground fault, short circuit, voltage fluctuation, abnormal interphase voltage, open phase, surge.</p>
AL45	Compressor over current	P.RUN	<p>Check that there is no power failure such as ground fault, short circuit, voltage fluctuation, abnormal interphase voltage, open phase, surge.</p>
AL47	Pump over current	A.STP	<p>Release the thermal trip "6.3.2 How to release the thermal relay trip and circuit protector trip".</p>
AL50	Incorrect phase error	A.STP	<p>The phase of the power line is connected by incorrect phase.</p>
AL51	Phase board over current	A.STP	<p>Check that there is no power failure such as ground fault, short circuit, voltage fluctuation, abnormal interphase voltage, open phase, surge. Release the circuit protector trip referring to [6.3.2 How to release the thermal relay trip and circuit protector trip].</p>

6.3.2 How to release the thermal relay trip and circuit protector trip

⚠ WARNING

 **Be sure to lock out and tag out the breaker of the facility power supply (user's power supply) before wiring.**

1. Turn OFF the earth leakage beaker of the user's power supply.
2. Remove four screws to remove the front panel for the electrical unit.

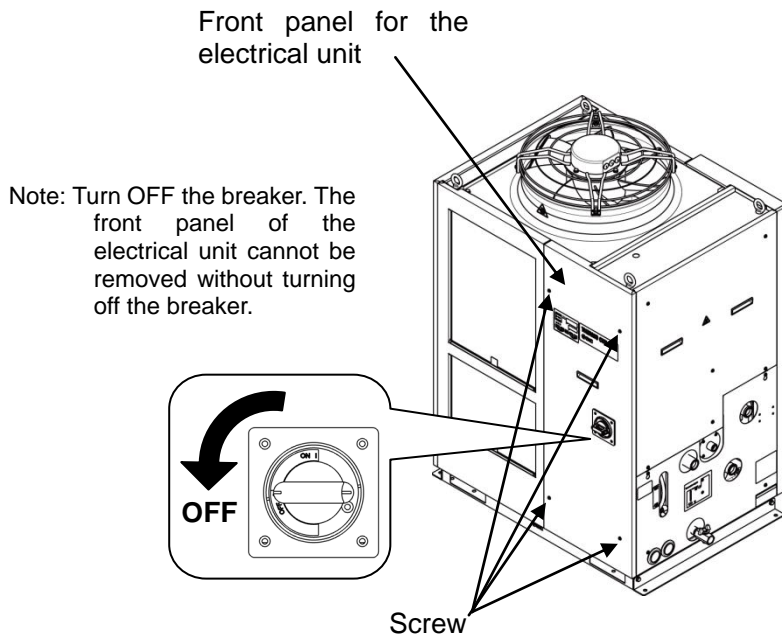

Fig. 6-1: Removal of the front panel of the electrical unit

3. Hold the handle and pull up the front panel of the electrical unit, and remove it.

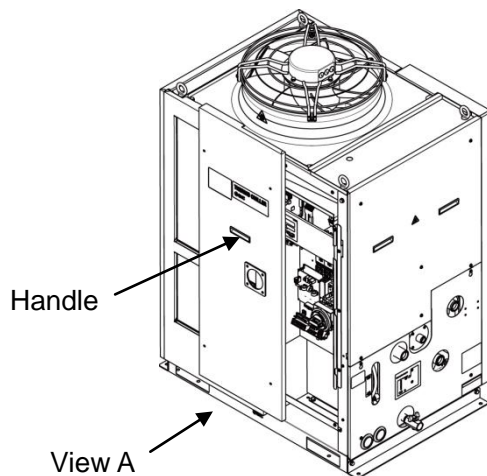

Fig. 6-2: Removal of the front panel of the electrical unit

4. Confirm if the thermal relay or the circuit protector are tripped. If the thermal relay tripped, push the reset button. If the circuit protector tripped, make it ON by pushing up the lever.

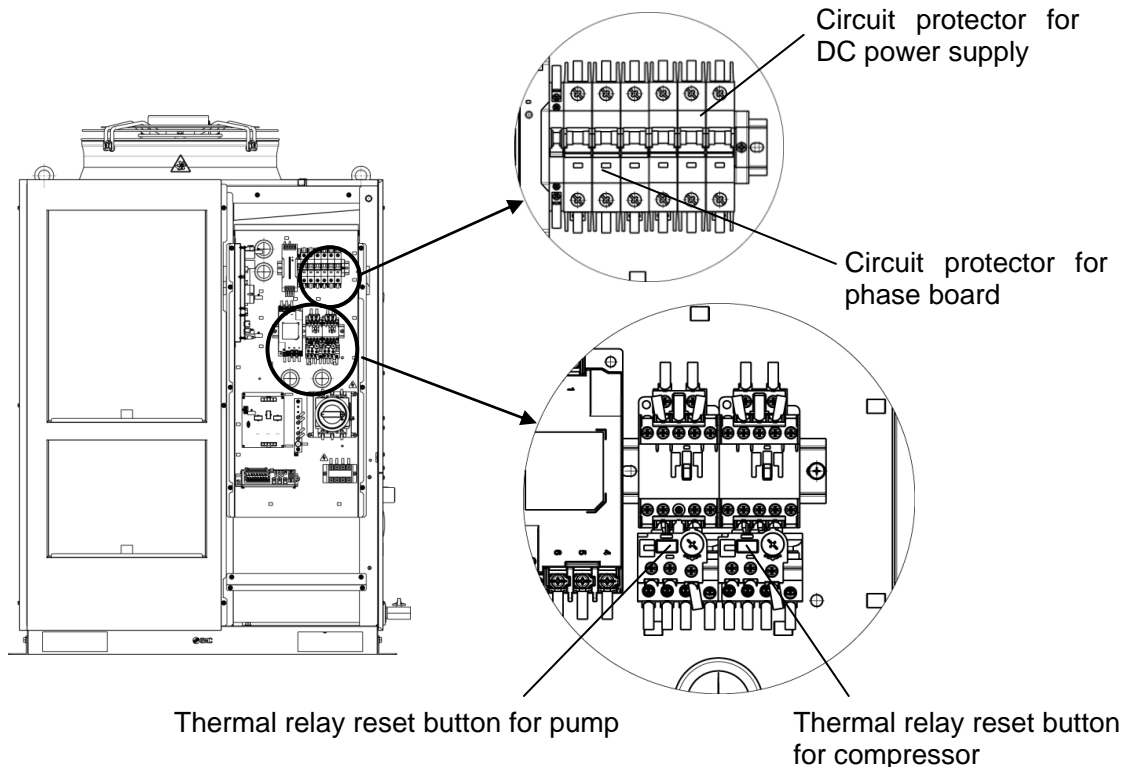



Fig. 6-3: Thermal relay and circuit protector location and statuses

Table 6-4 Setting value of the thermal relay

Model	For the compressor	For the pump
HRS200-A*-46-*S	18A	4A

5. Mount the front panel of the electrical unit.

⚠ WARNING



Be sure to mount the front panel of the electrical unit before turning ON the breaker of the main power supply (the power supply of the user's facility), or it may cause an electric shock and/or death.

6.4 Other Errors

■ How to check other errors

Possible causes and countermeasures for failures with no alarm number display are shown in "Table 6-5".

Table 6-5 Possible causes and countermeasures for failures without alarm number

Content of failure	Possible cause	Countermeasure
The operation panel displays nothing.	The breaker of the user's power supply or/and the optional breaker is/are not turned ON.	Turn ON the breaker.
	The breaker of the user's power supply or the optional breaker has failed.	Replace the breaker.
	No power supply. (e.g. Breaker(s) in the power supplying route has not been turned ON.)	Supply the power.
	The breaker for the user's facility or the optional breaker has tripped due to short-circuit or leakage of electricity.	Repair the short-circuited part or the electricity leaking part.
The [RUN] light does not turn ON when the [RUN/STOP] key is pressed.	Communication setting has been turned ON.	Check if the communication setting has been turned ON.
	Failure of the [RUN] light	Replace the controller.
	Failure of the [RUN/STOP] key	Replace the controller.

* Check the supply voltage with a tester.

Chapter 7 Control, Inspection and Cleaning

7.1 Quality Control of Circulating Fluid and Facility Water

⚠ WARNING



Use specified fluids only. If other fluids are used, they may damage the product, causing fluid leakage, or result in hazards such as electric shock or leakage of electricity.
When using clear water (tap water), ensure that it satisfies the water quality criteria shown in the table below.

Table 7-1 Quality criteria for clean water (tap water)

	Item	Unit	Criterion	
			Circulating fluid	Facility water
Standard item	pH (at 25 °C)	—	6.0 to 8.0	6.5 to 8.2
	Electric conductance (at 25 °C)	[µS/cm]	100 to 300	100 to 800
	Chloride ion	[mg/L]	50 or less	200 or less
	Sulphate ion	[mg/L]	50 or less	200 or less
	Acid consumption (at pH 4.8)	[mg/L]	50 or less	100 or less
	Total hardness	[mg/L]	70 or less	200 or less
	Calcium hardness	[mg/L]	50 or less	150 or less
	Ionic silica	[mg/L]	30 or less	50 or less
Referential item	Iron	[mg/L]	0.3 or less	1.0 or less
	Copper	[mg/L]	0.1 or less	0.3 or less
	Sulfide ion	[mg/L]	Should not be detected any	Should not be detected any
	Ammonium ion	[mg/L]	0.1 or less	1.0 or less
	Residual chlorine	[mg/L]	0.3 or less	0.3 or less
	Free carbon dioxide	[mg/L]	4.0 or less	4.0 or less

* Quoted from the standard "JRA-GL-02-1994", The Japan Refrigeration and Air Conditioning Industry Association.

⚠ CAUTION



Replace the circulating fluid if any problems are found in the regular check. Even if no problems are found, some of the water in the tank evaporates and impurity concentration in the circulating fluid increases. Replace the circulating fluid on the tank once in every 3 months. Refer to the section "7.2 Inspection and Cleaning" for regular inspection.

7.2 Inspection and Cleaning

⚠ WARNING



- Do not perform key operation or setting of this equipment with wet hands. Do not touch the electrical parts such as the power supply plug. It may cause an electric shock.
- Do not splash water directly on the product or do not wash with water. It might cause electric shock, fire, or etc.
- Do not touch the fins directly when cleaning the dust-proof filter. It may cause injury.

⚠ WARNING



- Shut off the power supply to this product before performing cleaning, maintenance or inspection, or it may cause electric shock, injury, burn, or etc.
- When the panel has been removed for the purpose of inspection or cleaning, mount the panel after the work is completed. If the product is operated with the panel removed or open, it may cause injury or electric shock.

7.2.1 Daily check

Check the items listed below. If any abnormality is found, stop the operation of the product and turn the power supply OFF, and ask for service.

Table 7-2 Daily check items

Item	Contents of check	
Installation condition	Check the installation condition of the product.	Check that there is no heavy object on the product or excessive force applying to the piping.
		Temperature should be within the specification range of the product.
Fluid leakage	Check the connected parts of the piping.	Check that there is no fluid leakage from the connected parts of the piping.
Amount of circulating fluid	Check the liquid level indicator.	Fluid level should be between "HIGH" and "LOW" levels of the fluid level meter.
Operation panel	Check the indications on the display.	The numbers shown on the display should be clear and legible.
	Check the functionality.	Check that the keys, [RUN/STOP], [MENU], [SEL], [▼], and [▲], operate correctly.
Circulating fluid temperature	Check on the operation panel.	There should be no problem for operation.
Circulating fluid flow rate	Check on the operation panel.	There should be no problem for operation. If flow rate has become smaller, check for any clogging of the Y-strainer and clean it.
Operating condition	Check the operating condition of the product	There should be no abnormality with noise, vibration, smell, or generation of smoke.

7.2.2 Monthly check

Table 7-3 Contents of monthly check

Item	Contents of check	
Ventilating condition	Clean the ventilating grilles.	Make sure the ventilating grilles are not clogged with dust, etc.

■ Cleaning of air ventilation port (Air cooled type.)

CAUTION



If the fins of the air-cooled condenser become clogged with dust or debris, heat radiation performance declines. This will result in the reduction of cooling performance, and may stop the operation because the safety device is triggered.

Clean the dust-proof filters with a long bristled brush or by air blow to prevent the fins from being deformed or damaged.

■ Removal of the dust-proof filter

1. The dust-proof filters are installed on the front and left sides of the product. The dust-proof filters are mounted at four sections. They are all identical in shape.
-
2. They can be removed as shown in the drawing below. Care should be taken not to deform or scratch the air cooled condenser (fins) while removing the filters.

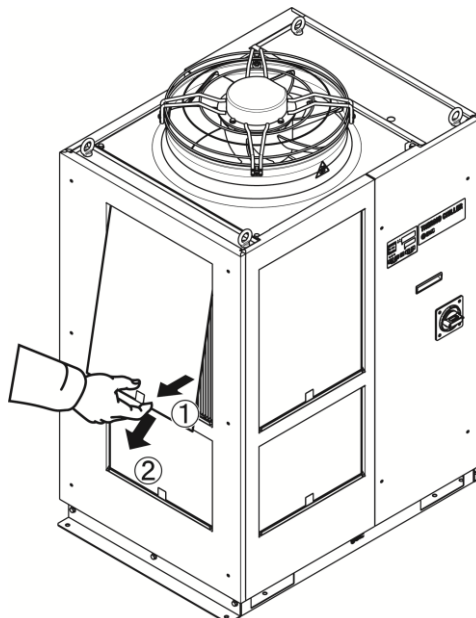

Fig. 7-1: Removal of the dust-proof filter

■ **Cleaning of dust-proof filter**

Clean the dust-proof filters with a long bristled brush or by air blow.

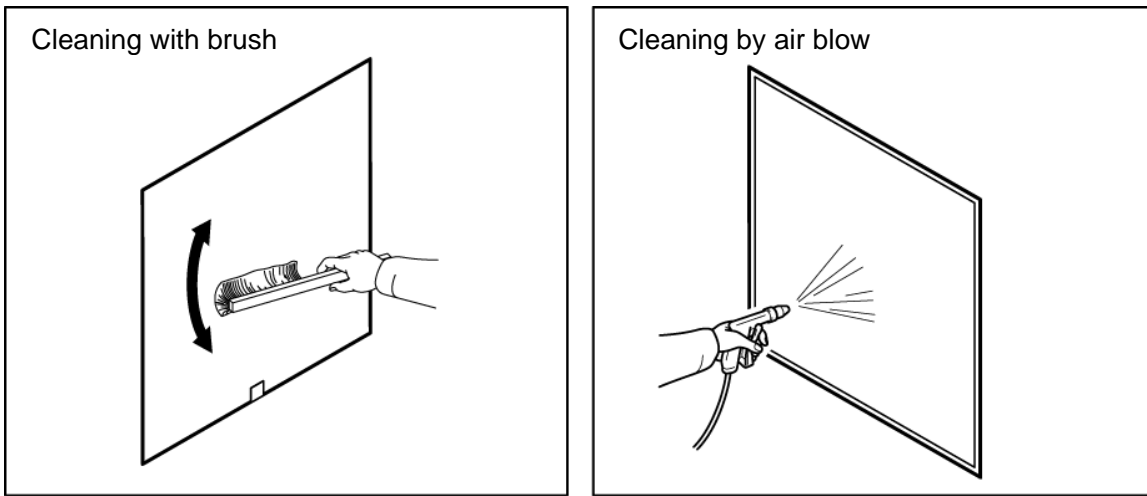

Fig. 7-2: Cleaning of the dust-proof filter

■ **Mounting of dust-proof filters**

Reassemble the filters in the reverse order to the removing procedure.

7.2.3 Inspection every 3 months

Table 7-4 Contents of every 3 months check

Item	Contents of check	
Power supply	Check the power supply voltage.	- Make sure the supply voltage is within the specification range.
Circulating fluid	Replace the circulating water (clean water) periodically.	- Ensure that the water has not been contaminated and that there is no algae growth. - Circulating water inside the tank must be clean and there must not be foreign matter inside. - Use clean water or pure water. The water quality must be within the range shown in Table 7-1 Quality criteria for clean water (tap water). * It is recommended to replace the circulating fluid every 3 months when periodic maintenance is performed.
	Density control (When using 15% concentration ethylene glycol aqueous solution)	- Density must be within the range of 15 % +5/-0.

■ Replacement of circulating fluid

- Replace the circulating fluid with new clean fluid periodically, or it may get algae or decompose.
- Circulating fluid to be supplied in the tank should satisfy the water quality specified in “Table 7-1: Quality criteria for clean water (tap water)”.
- Make sure that the concentration of ethylene glycol aqueous solution is 15%+5/0 when 15% ethylene glycol solution is used.
- When using the Y strainer provided as an accessory for piping, clean the screen mesh inside the strainer at the same time as when replacing the circulating fluid.

Ensure that there is no circulating fluid in the thermo-chiller, user's equipment, and piping. Remove the cap and take out the screen mesh inside, and clean the screen mesh with compressed air or detergent. Use caution not to damage the screen mesh.

Do not use chlorine-based or such types of detergents or cleansers. Put the screen mesh that has been cleaned into the groove in the cap, and reassemble it to the body of the strainer.

CAUTION



If there is foreign matter accumulated or clogging in the facility water system, pressure loss increases with less flow rate, and it may damage the screen mesh.

7.2.4 Inspection during winter season

CAUTION	
	Keep the power supply ON for these functions. These functions do not start when the power is OFF.

■ Anti-freezing function

This function prevents freezing of the circulating fluid while the product stops operation in the winter season with heat generated by automatically operating the pump. When there is a possibility of the circulating fluid freezing due to changes in the installation or operating environment (e.g. season, weather), set this function ON in advance.

* For more details, refer to “5.11 Anti-freezing Function”.

■ Warming up function

This function maintains the circulating fluid temperature to the set warming-up temperature with heat generated by automatically operating the pump in the winter season or at night.

When the time required for increasing the temperature of the circulating fluid needs to be shortened at startup, set this function ON in advance.* For more details, refer to “5.17 Warming Up Function”.

■ Anti-snow coverage function

This function prevents snow coverage on the exhaust port on top of the product during the winter time by automatically operating the fan periodically.

When there is a possibility of snow coverage due to changes in the installation or operating environment (e.g. season, weather), set this function ON in advance.

* For more details, refer to “5.18 Anti-Snow Coverage Function”.

7.3 Consumables

Replace the following parts depending on their condition.

Table 7-5 Consumables

Part number	Name	Qty.	Remarks
HRS-S0213	Dust-proof filter (Lower)	1 pc.	2 pcs. are used per unit
HRS-S0214	Dust-proof filter (Upper)	1 pc.	2 pcs. are used per unit

7.4 Operation Stop for an Extended Period of Time

If there is a concern that the product will not be operated for an extended period of time or there is a possibility of freezing in the winter time, take the measures according to the instructions shown below.

1. Turn OFF the earth leakage breaker of the user's power supply.

2. Discharge all the circulating fluid completely from the thermo-chiller.
Refer to "7.4.1 Discharge of the circulating fluid" for the method of drain the circulating fluid from the product.

3. After discharging the circulating fluid, cover the product with a sheet (to be prepared by user) before storing the product.

7.4.1 Discharge of the circulating fluid

WARNING



- Before discharging the circulating fluid, stop the user's equipment and release the residual pressure.

CAUTION

- For relocation or long-term storage, drain the residual liquid in the piping as much as possible. Residual liquid may drip during movement or installation.

1. Turn OFF the breaker of the user's power supply.

2. Close the valve at the automatic water fill port.

3. Open the ball valve at the tank drain port, and discharge the circulating fluid.

4. Confirm that all the circulating fluid has been discharged completely from the user's equipment and piping, and then purge air to the circulating fluid outlet port of the product.

5. Close the ball valve after discharging the circulating fluid.

Chapter 8 Documents

8.1 Specifications

8.1.1 HRS200-A*-46-*S*

Table 8-1 Specifications

Model		HRS200-A*-46-*S*			
Cooling method		Air-cooled refrigeration			
Refrigerant		R410A (HFC)			
Quantity of refrigerant		kg	1.65		
Control method		PID control			
Ambient temperature ^{*1 *2 *8}		°C	-5 to 45		
Circulating fluid system	Circulating fluid ^{*1 *2}		Clean water, 15% ethylene glycol aqueous solution, Deionized water		
	Operating temperature range ^{*1}		°C	5 to 35	
	Cooling capacity ^{*3} 50/60Hz		kW	17.5 / 20.5	
	Heating capacity ^{*4} 50/60Hz		kW	3.3 / 5.3	
	Temperature stability ^{*5}		°C	±1	
	Pump capacity 50/60Hz	Rated flow rate (Outlet)		L/min	45 (0.31 / 0.45 MPa)
		Maximum flow rate		L/min	110 / 130
		Maximum lifting height		m	36 / 50
	Minimum operating flow rate ^{*6}		L/min	25	
	Tank capacity		L	25	
	Port size		Rc1 (Symbol F: G1, Symbol N: NPT1)		
	Tank port size		Rc3/4 (Symbol F: G3/4, Symbol N: NPT3/4)		
	Automatic water fill function (Standard)	Supply side pressure range		MPa	0.2 to 0.5
		Supply side water temp. range		°C	5 to 35
Automatic water fill port size		Rc1/2 (Symbol F: G1/2, Symbol N: NPT1/2)			
Over flow port size		Rc1 (Symbol F: G1, Symbol N: NPT1)			
Fluid contact part material		Metal	Stainless steel, Copper (Brazing filler metal for the heat exchanger), Bronze, Brass,		
		Resin	PTFE, PU, FKM, EPDM, PVC, NBR, POM, PE, NR		
Electrical system	Power supply		50Hz	3 phase 380 to 415 VAC Allowable voltage fluctuation ±10% (No continuous voltage fluctuation)	
			60Hz	3 phase 460 to 480 VAC Allowable voltage fluctuation +4%, -10% (Maximum voltage less than 500 VAC and no continuous voltage fluctuation)	
	Applicable earth leakage breaker ^{*8}	Rated current		A	30
		Sensitivity current		mA	30
	Rated operating current ^{*5} 50/60Hz		A		13.4 / 14.2
Rated power consumption ^{*5} 50/60Hz		kW (kVA)		6.8 / 9.1 (9.4 / 11.4)	
Noise level (Front: 1m./height: 1m) ^{*5}		dB(A)		75	
Water-proof specification				IPX4	
Accessories				Alarm code list label 1pc., Operation Manual 1 copy, Y strainer (40 mesh) 25A, Barrel nipple 25A, Anchor bracket 2 pcs. (including 6 pcs. of M8 bolts) ^{*7}	
Weight (in the dry state)		kg		Approx. 214	

- *1: When the ambient temperature or circulating fluid temperature is 10 °C or below, refer to "3.2.2 Operation at low ambient temperature or low circulating fluid temperature".
- *2: Use fluid for circulating fluid that conforms to:
Clean water: Water Quality Standards of the Japan Refrigeration and Air Conditioning Industry Association (JRA GL-02-1994)
15% ethylene glycol aqueous solution: Diluted with clean water, without any additives such as antiseptics.
DI water (pure water): Electrical conductivity 1 μS/cm or more (electrical resistivity 1MΩ·cm or less)
- *3: (1) Ambient temperature: 32 °C, (2) Circulating fluid: Clean water, (3) Circulating fluid temperature: 20 °C, (4) Circulating fluid flow rate: Rated flow rate, (5) Power supply: 400 VAC(50Hz)/460 VAC(60Hz)
- *4: (1) Ambient temperature: 32 °C, (2) Circulating fluid: Clean water, (3) Circulating fluid flow rate: Rated flow rate
(4) Power supply: 400 VAC(50Hz)/460 VAC(60Hz)
- *5: (1) Ambient temperature: 32 °C, (2) Circulating fluid: Clean water, (3) Circulating fluid temperature: 20 °C, (4) Load: Refer to the cooling capacity shown in the specification table, (5) Circulating fluid flow rate: Rated flow rate, (6) Power supply: 400 VAC(50Hz)/460 VAC(60Hz)
(7) Piping length: Minimum
- *6: Required flow rate to maintain the cooling capacity. When the flow rate is lower than the rated flow, use a by-pass piping set.
- *7: The anchor brackets (including M8 bolts x 6 pcs.) are used for fixation with the skid when this product is packed. The anchor bolts are not attached.
- *8: For the product operation in the UL compliant conditions, refer to "3.2.1 Environment".

8.1.2 Refrigerant with GWP reference

Table 8-2 Refrigerant with GWP reference

Refrigerant	Global Warming Potential (GWP)	
	Regulation (EU) No 517/2014 (Based on the IPCC AR4)	Revised Fluorocarbons Recovery and Destruction Law (Japanese law)
R134a	1,430	1,430
R404A	3,922	3,920
R407C	1,774	1,770
R410A	2,088	2,090

Note:

1. This product is hermetically sealed and contains fluorinated greenhouse gases.
2. See specification table for refrigerant used in the product.

8.1.3 Communication specifications

- For communication specifications, refer to Operation Manual Communication Function, HRX-OM-S010.

8.2 Dimensions

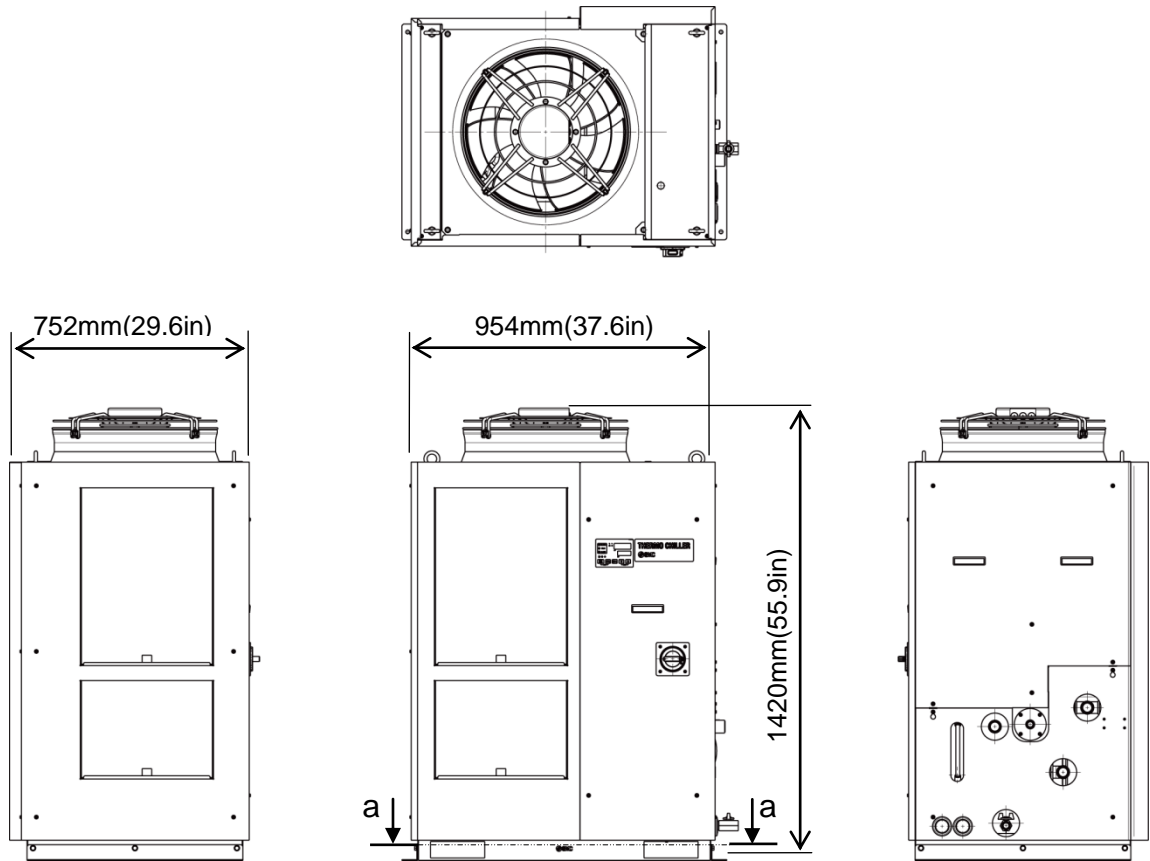
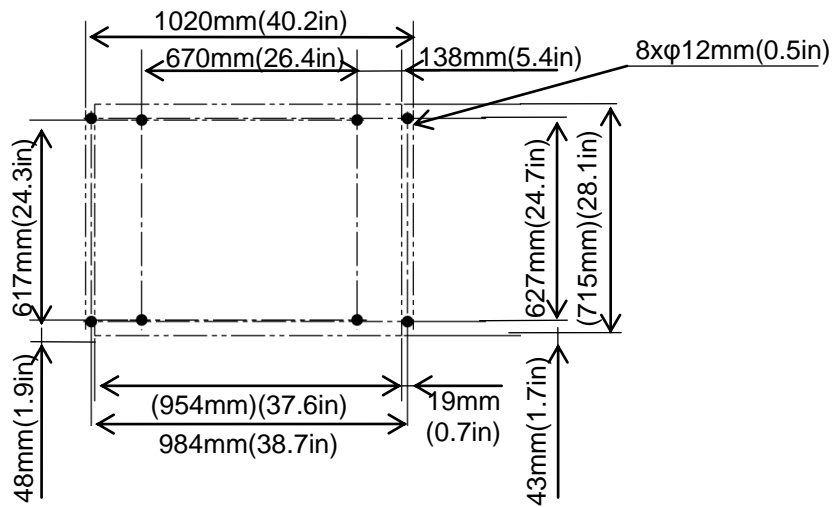

Fig. 8-1: Dimensions



Dimensions for the positions of the anchor bolts (View a-a)

8.3 Flow Diagram

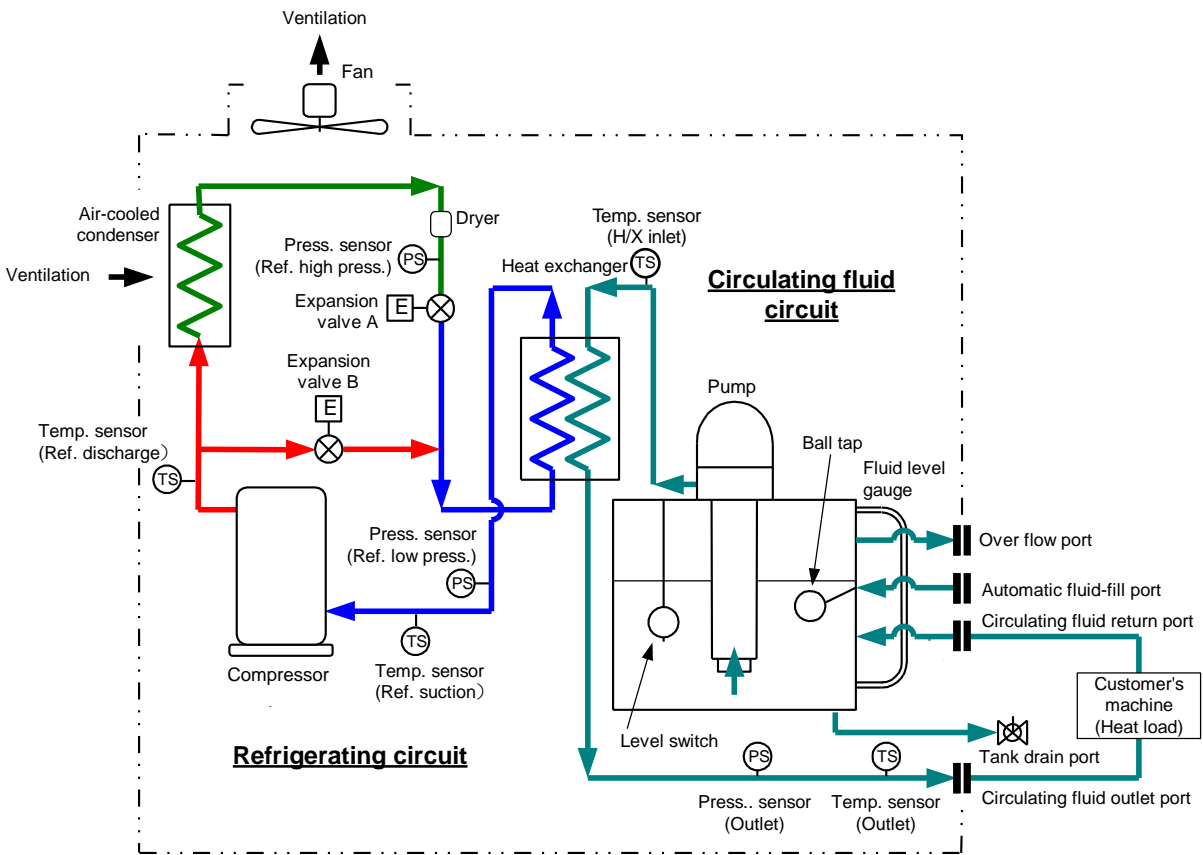

Fig. 8-2: Flow Diagram

8.4 Cooling Capacity

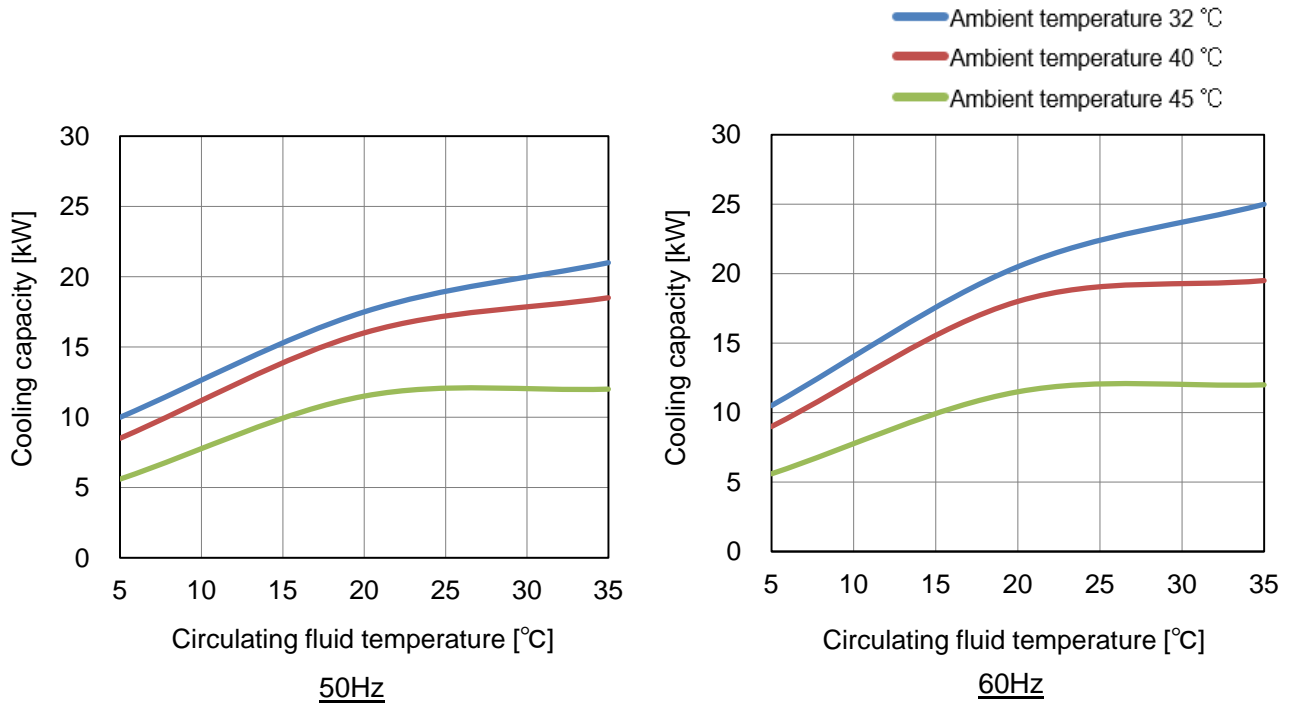

Fig. 8-3: Cooling Capacity

8.5 Pump Capacity

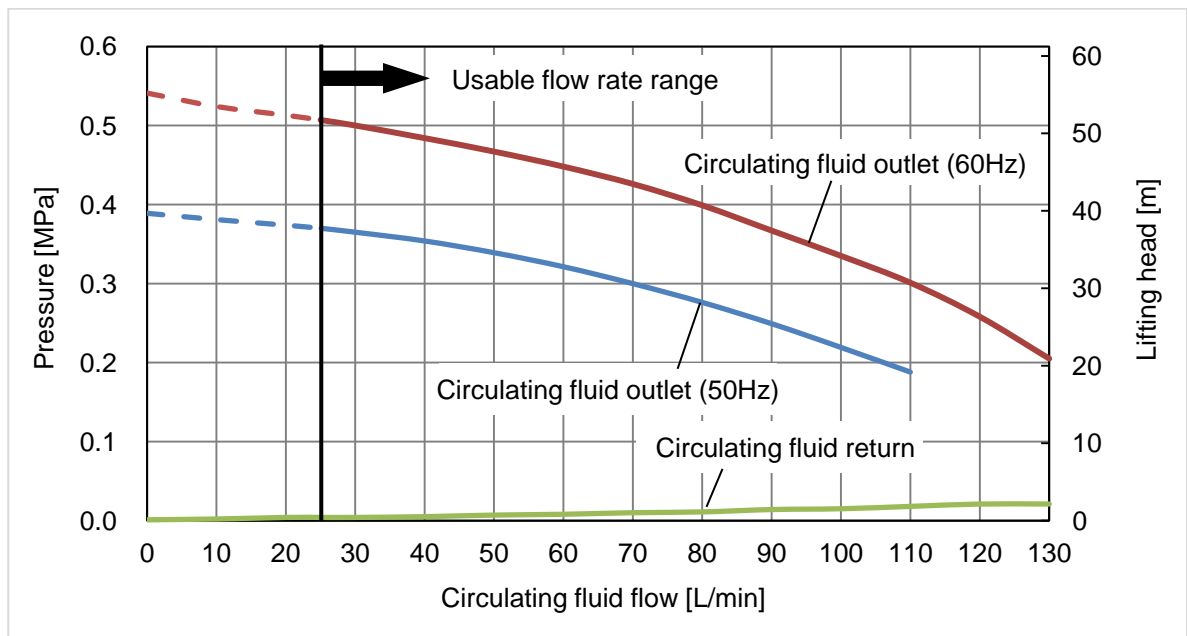



Fig. 8-4: Pump capacity

8.6 Types of Hazard Labels



To ensure the safety of the operators, potential hazards are classified and marked with warning labels.

Read this section before starting any work on the product.



■ Electric shock warning

 WARNING	
	<p>This symbol stands for danger of electric shock. The product has some uncovered terminals applied with high voltage inside.</p> <ul style="list-style-type: none">● Do NOT operate the product without the cover panels mounted.● Do NOT work on the parts inside the product unless you have been trained for the product service.● Do NOT work inside this product unless you have been trained to do so.



■ High temperature warning

 WARNING	
	<p>This symbol stands for danger of burns. The product has surfaces that can reach high temperatures during operation. Even after the power is turned off, there can still be residual heat in the product., which causes burns.</p> <ul style="list-style-type: none">● Do NOT operate the product without cover panels fitted.● Do NOT start working on the parts inside the product until the temperature has decreased sufficiently.

■ Rotating objects warning

 WARNING	
	<p>This symbol stands for a danger of your fingers/hand being cut or getting caught by the rotating objects.</p> <ul style="list-style-type: none">● The product contains a cooling fan that rotates during operation of the product. The fan may stop and restart intermittently during operation. Do NOT operate the product without the cover panels mounted.

■ Warning related to those other than shown above

 WARNING	
	<p>This symbol stands for a multiplex danger.</p> <p>Electric shock: The product has some uncovered terminals applied with high voltage.</p> <p>Rotary fan: This product has a rotating object inside the cover panel.</p> <p>High pressure inside: This product contains high pressure liquid in the piping and the tank.</p> <p>- Do not operate the product without the cover panels mounted.</p>

8.6.1 Positions of danger warning label

Confirm the positions of the danger warning labels on the product to show the potential danger before starting operation.

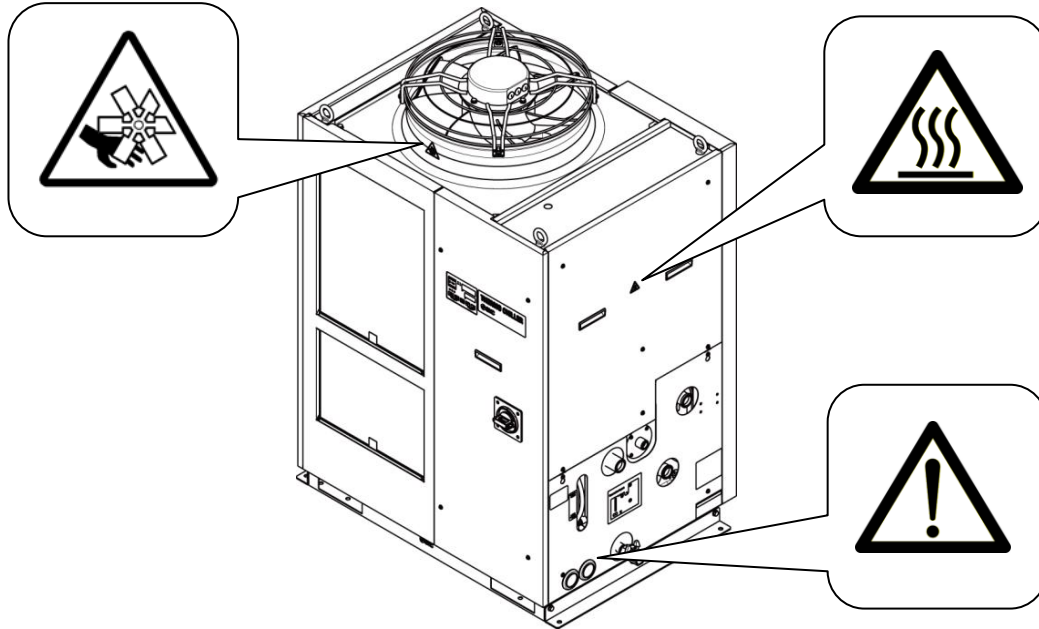

Fig. 8-5: Positions of danger warning label

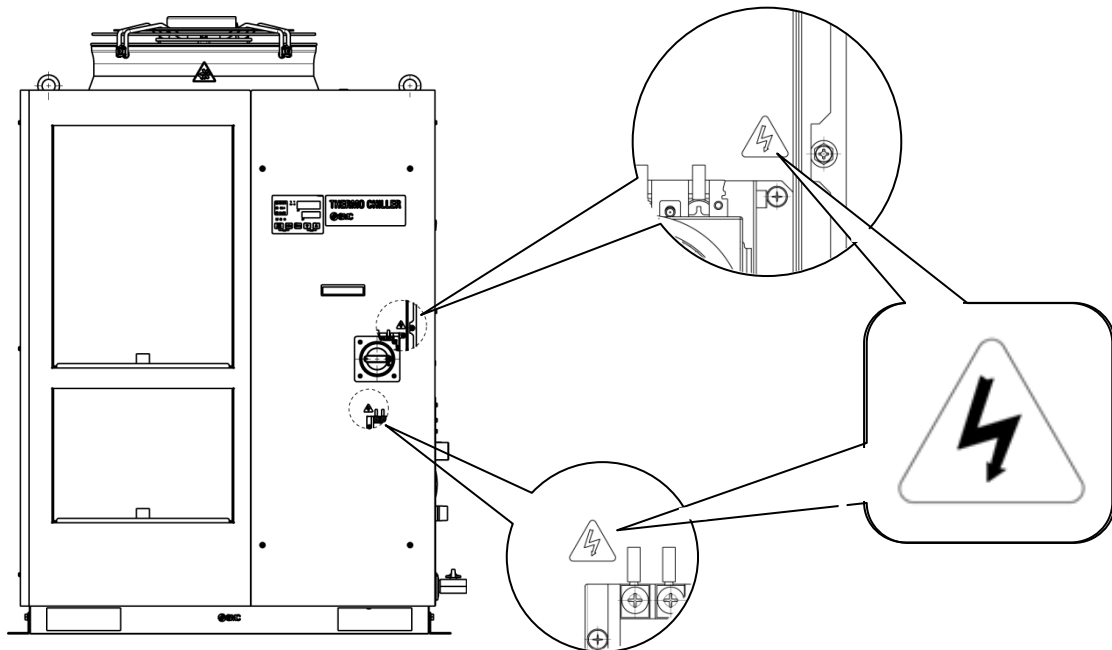

Fig. 8-6: Positions of danger warning label

8.7 Standards

This product complies with the standards shown below.

Table 8-3 Standards

Standard		
CE Mark	EMC Directive	2014/30/EU
	Machinery Directive	2006/42/EC
	RoHS Directive	2011/65/EU
UL/CSA standard (NRTL certified)	UL61010-1 3 rd edition	
	CSA C22.2 No.61010-1 3 rd edition	

8.8 Sample DoC.



Sample DoC

EU DECLARATION OF CONFORMITY

Original declaration

SMC Corporation
4-14-1 Soto-Kanda, Chiyoda-ku, Tokyo 101-0021 Japan

declares under its sole responsibility, that the following equipment:

Thermo Chiller

HRS Series

Serial No.: VU0001 onwards

is in conformity with the relevant Union harmonisation legislation and has been demonstrated to fulfil the requirements with reference to the harmonised standard(s) as listed below

Directive	Requirements	Harmonised standards
Machinery Directive 2006/42/EC	All applicable Essential Health and Safety Requirements of Annex I	EN / ISO 12100:2010 EN 60204-1:2006 + A1:2009
EMC Directive 2014/30/EU	Essential requirements set out in Annex I	EN 61000-6-2:2005 EN 55011:2009 + A1:2010
RoHS Directive 2011/65/EU	Restriction of substances as set out in Annex II	EN50581:2012

Name and address of the person authorised to compile the technical file:

Mr. G. Berakoetxea, Executive Officer, SMC European Zone,
SMC España, S.A., Zuazobidea 14, 01015 Vitoria, Spain

Importer/Distributor in EU and EFTA:

Country	Company	Telephone	Address
Austria	SMC Pneumatik GmbH (Austria)	(43) 2262-62280	Girakstrasse 8, AT-2100 Korneuburg
Belgium	SMC Pneumatics N.V./S.A.	(32) 3-355-1464	Nijverheidsstraat 20, B-2160 Wommelgem
Bulgaria	SMC Industrial Automation Bulgaria EOOD	(359) 2 9744492	Business Park Sofia, Building 8-6th Floor, BG-1715 Sofia
Croatia	SMC Industrijska Automatika d.o.o.	(385) 1 370 72 88	Zagrebačka Avenija 104, 10 000 Zagreb
Czech Republic	SMC Industrial Automation CZ s.r.o.	(420) 541-424-611	Hudcova 78a CZ-61200 Brno
Denmark	SMC Pneumatik A/S	(45) 70 25 29 00	Egeskovvej 1, DK-8700 Horsens
Estonia	SMC Pneumatics Estonia OU	(372) 651-0370	Laki 12, EE-10621 Tallinn
Finland	SMC Pneumatikka Finland Oy	(358) 207 513 513	PL72, Tiistiniityntie 4, SF-02031 Espoo
France	SMC France	(33) 1-6476-1000	1 Boulevard de Strasbourg, Parc Gustave Eiffel, Bussy Saint Georges, F-77607, Marne La Vallée, Cedex 3
Germany	SMC Deutschland GmbH	(49) 6103-402-0	Boschring 13-15, D-63329 Egelsbach
Greece	SMC Hellas E.P.E	(30) 210-2717265	Anageniseos 7-9 - P.C. 14342, Nea Philadelphia, Athens
Hungary	SMC Hungary Ipari Automatizálási Kft.	(36) 23-511-390	Torbágy u. 19, HU-2045 Törökbalint
Ireland	SMC Pneumatics (Ireland) Ltd.	(353) 1-403-9000	2002 Citywest Business Campus, Naas Road, Saggart, Co. Dublin
Italy	SMC Italia S.p.A.	(39) 02-9271-1	Via Garibaldi, 62, I-20061 Carugate, Milano
Latvia	SMC Pneumatics Latvia SIA	(371)781-77-00	Dzelzavas str. 120g, Riga, LV-1021
Lithuania	SMC Pneumatics Lietuva,UAB	(370)5-264-81-26	Oslo g.1, LT-04123 Vilnius
Netherlands	SMC Pneumatics B.V.	(31) 20-531-8888	De Ruyterkade 120, NL-1011 AB Amsterdam
Norway	SMC Pneumatics Norway AS	(47) 67-12-90-20	Vollsveien 13c, Granfoss Næringspark, N-1366 Lysaker
Poland	SMC Industrial Automation Polska Sp. zo.o	(48) 22 211 96 00	ul. Poloneza 89, PL-02-826 Warszawa
Portugal	SMC Sucursal Portugal, S.A.	(351) 945-184 100	Rua De Eng Ferrerira Dias 452 4100-246,Porto
Romania	SMC Romania S.r.l.	(40)21-3205111	Str. Frunzei, Nr.29, Sector 2 Bucharest
Slovakia	SMC Priemyseľna Automatizacia, Spol s.r.o.	(421) 41-321321-1	Fantránská 1223, Teplicka nad vahom, 01301
Slovenia	SMC Industrijska Avtomatika d.o.o.	(386) 7388 5412	Mirnska cesta 7, SLO-8210 Trebnje
Spain	SMC España, S.A.	(34) 945-184-100	Zuazobidea 14, 01015 Vitoria
Sweden	SMC Pneumatics Sweden AB	(46) 8-603-12-00	Ekhagsvägen 29-31, SE-14171 Segeltorp
Switzerland	SMC Pneumatik AG	(41) 052-396-3131	Dorfstrasse 7, Postfach 117, CH-8484, Weislingen
United Kingdom	SMC Pneumatics (U.K.) Ltd.	(44) 1908-563888	Vincent Avenue, Crownhill, Milton Keynes, Bucks MK8 0AN

Tokyo, 22nd July 2017

Hiroyuki Sakama
General Manager
Product Development Division -VI

SMC® Thermo-chiller Daily Check Sheet

Model no. _____
Mfg. code _____

For information about how to perform daily checks of the thermo chiller, refer to section "8.2.1 Daily Check" of the operation manual.
Check and record the condition at start right after setting up.

Date	Performed by	Setting up conditions		Fluid leakage	Fluid amount		Operation panel		Circulating fluid circuit			Facility water circuit (Water-cooled only)			Operation conditions		Result
		Temperature °C	Humidity %		Present/ Not present	Inside/Outside of liquid level indicator range	Display	Operation	Temperature °C	Flow rate L/min	Discharge press. MPa	Supply temp. °C	Flow rate L/min	Supply press. MPa	outlet press. MPa	Presence of error Present/Not present	
Initial value (Default setting)																	

Chapter 9 Product Warranty

1. Period

The warranty period of the product is 1 year in service or 1.5 years after the product is delivered whichever comes first.

2. Scope

For any failure reported within the warranty period which is clearly SMC's responsibility, replacement parts will be provided. In that case, removed parts shall become the property of SMC.

This guarantee applies only to SMC's product independently, and not to any other damage incurred due to the failure of the product.

3. Contents

1. SMC guarantees that the product will operate normally if it is installed under maintenance and control in accordance with the Operation Manual, and operated under the conditions specified in the catalog or contracted separately.
2. SMC guarantees that the product does not have any defects in components, materials or assembly.
3. SMC guarantees that the product complies with the outline dimensions provided.
4. The following situations are out of scope of this warranty.
 - (1) The product was incorrectly installed or connected with other equipment.
 - (2) The product was under insufficient maintenance and control or incorrectly handled.
 - (3) The product was operated outside of the specifications.
 - (4) The product was modified or altered in construction.
 - (5) The failure was a secondary failure of the product caused by the failure of equipment connected to the product.
 - (6) The failure was caused by a natural disaster such as an earthquake, typhoon, or flood, or by an accident or fire.
 - (7) The failure was caused by operation different from that shown in the Operation Manual or outside of the specifications.
 - (8) The checks and maintenance specified (daily checks and regular checks) were not performed.
 - (9) The failure was caused by the use of circulating fluid or facility water other than those specified.
 - (10) The failure occurred naturally over time (such as discoloration of a painted or plated face).
 - (11) The failure does not affect the functioning of the product (such as new sounds, noises and vibrations).
 - (12) The failure was due to the "Installation Environment" specified in the Operation Manual.
 - (13) The failure was caused by the customer disregarding "6. Request to Customers".

4. Agreement

If there is any doubt about anything specified in "2. Scope" and "3. Contents", it shall be resolved by agreement between the customer and SMC.

5. Disclaimer

- (1) Expenses for daily and regular checks
- (2) Expenses for repairs performed by other companies
- (3) Expenses for transfer, installation and removal of the product
- (4) Expenses for replacement of parts other than those in this product, or for the supply of liquids
- (5) Inconvenience and loss due to product failure (such as telephone bills, compensation for workplace closure, and commercial losses)
- (6) Expenses and compensation not covered in "2. Scope".

6. Request to Customers

Proper use and maintenance are essential to assure safe use of this product. Be sure to satisfy the following preconditions. Please note that SMC may refuse to carry out warranted repair if these preconditions have been disregarded.

- (1) Use the product following the instructions for handling described in the Operation Manual.
- (2) Perform checks and maintenance (daily checks and regular checks) specified in the Operation Manual and Maintenance Manual.
- (3) Record the check and maintenance results on the daily check sheet attached to the Operation Manual and Maintenance Manual.

7. Request for Warranted Repair

For warranted repair, please contact the supplier you purchased this product from.

Warranted repair shall be on a request basis.

Repair shall be provided free of charge in accordance with the warranty period, preconditions and terms defined above. Therefore, a fee will be charged for any repairs if a failure is detected after the end of the warranty period.

Revision
Rev. E: July, 2020

SMC Corporation

4-14-1, Sotokanda, Chiyoda-ku, Tokyo 101-0021 JAPAN
Tel: + 81 3 5207 8249 Fax: +81 3 5298 5362
URL <https://www.smcworld.com>

Note: Specifications are subject to change without prior notice and any obligation on the part of the manufacturer.
© 2020 SMC Corporation All Rights Reserved