

# Communication Manual

## THERMO-CON

*Model No.*

*HECR series*



Keep available whenever necessary.

This manual is copyrighted and all rights are reserved by SMC Corporation, and may not, in whole or in part, be copied, photocopied or translated without prior written consent of SMC.



## History

Version	Cover	Preface	Contents	Chap.1	Chap.2	Chap.3	Chap.4	Chap.5	Chap.6
1.0									
1.1	1.1								
1.2							1.2	1.2	

## Record of Changes

Version	Contents	Date
1.0	First edition	Aug.2014
1.1	Cover: Change Model No, Add picture	Jun.2015
1.2	4.10, 5.11:Change Communication Format and Examples of Answers from Thermo-con	May.2017

# Preface

Thank you very much for purchasing SMC Thermo-con.

This manual contains description for communication of this product for your full benefit from this product.

Read the operation manual carefully before use of this product, and understand the outline of the product and safety instructions well. Instructions in the categories, “Danger”, “Warning” and “Caution”, are important for safety and must be duly followed.

Please contact the following for any question and unclear points regarding the Thermo-con.

SMC Corporation R&D Center

Product Development Division-6

Address: 4-2-2, KINUNODAI, TSUKUBAMIRAI-CITY , IBARAKI-KEN 300-2493, JAPAN

Phone:+81-297-52-6666

Fax:+81-297-20-5007

E-mail:kaihatsu\_6\_g3@smcjpn.co.jp

Notice: The content of this manual can be revised without a previous notice.

# CONTENTS

1	Preparation for Communication .....	1-1
2	Specifications of Communication Method .....	2-1
3	Communication Format (same as current HEC series) .....	3-1
3.1	Control code used for communication.....	3-1
3.2	Command code list.....	3-1
3.3	Communication procedures and format .....	3-2
3.4	Calculation of Check Sum.....	3-4
4	Details of Communication Format.....	4-1
4.1	Temperature setting (without writing FRAM) .....	4-1
4.2	Reading setting temperature.....	4-1
4.3	Reading internal sensor .....	4-2
4.4	Reading external sensor .....	4-3
4.5	Reading alarm status.....	4-3
4.6	Offset setting (without writing FRAM).....	4-5
4.7	Reading offset .....	4-5
4.8	Temperature setting (with writing FRAM) .....	4-6
4.9	Offset setting (with writing FRAM).....	4-7
4.10	Communication Format and Examples of Answers from Thermo-con .....	4-8
5	MODBUS communication function.....	5-1
5.1	Precautions for communication.....	5-1
5.2	Communication specification .....	5-2
5.3	Setting and checking .....	5-2
5.4	Communication sequence .....	5-4
5.5	Message configuration.....	5-5
5.6	Function codes .....	5-7
5.7	LRC .....	5-7
5.8	Explanation of function codes .....	5-8
5.9	Negative response.....	5-12
5.10	Register Map .....	5-13
5.11	Communication Format and Examples of Answers from Thermo-con .....	5-16
6	Troubleshooting.....	6-1



# 1 Preparation for Communication

Make preparation for using communication facility as follows.

- 1) Turn off the power switch of Thermo-con.
- 2) Connect communication cable to communication connector (RS-485 or RS-232C) of Thermo-con.
  - Use twist pair shield cable as communication cable.
  - Connect the host and thermo-con with the straight cable for RS-485 and the cross cable for RS-232C .
  - Connect shielded cable of communication cable to communication connector and drop it to FG(flame ground).
  - Connection drawing for communication is shown in the Figures 1-1 and 1-2.
  - Length of communication cable for RS-485 shall be limited to around 500[m] in total, and that for RS-232C shall be 15[m].
  - If communication cable for RS-485 is longer, set the terminating resistance (120 ohm) on.
- 3) Turn on the power switch of Thermo-con.
- 4) Select communication types for all Thermo-cons. See the operation manual of the details.
- 5) That's all for preparation of communication. Then if a communication command from the host computer is given, each Thermo-con will reply it.

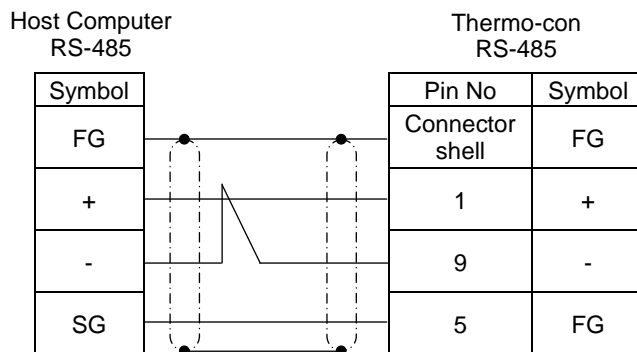

Figure1-1 Communication Connection (RS-485)

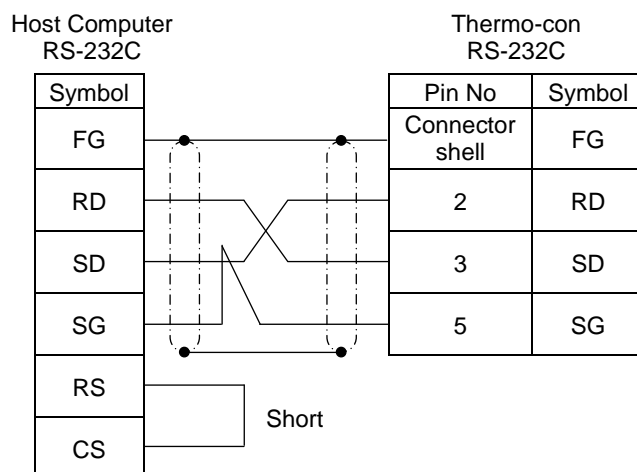

Figure1-2 Communication Connection (RS-232C)





## 2 Specifications of Communication Method

•Standards .....	Select RS-485 or RS-232C
•Circuit type .....	Half duplex
•Communication type .....	Asynchronous
•Communication speed .....	Changeable, 600, <u>1200</u> ,2400,4800,9600,19200 bps
•Character code .....	ASCII
•Parity .....	Select, <u>Nil</u> , even number, odd number
•Start bit .....	1 bit
•Data length .....	Select 7 bit or <u>8 bit</u> .
•Stop bit .....	Select <u>1 bit</u> or 2 bit.
•Block check .....	Sum check

Note: Values underlined indicate default values at all reset.

It is set to these values when delivered.

Two communication protocols are available.

- 1) The same communication protocol as the conventional HEC Series thermo-controller (Refer to Chapter 3 and 4)
- 2) Modbus communication protocol (Refer to Chapter 5)

In addition to the specification shown in 1), functions of drive mode setting (Drive ON/OFF), control parameter setting and output ratio display are also added to the product with the Modbus communication protocol.



### 3 Communication Format (same as current HEC series)

#### 3.1 Control code used for communication

Control code	ASCII code
ENQ	05H
STX	02H
ETX	03H
ACK	06H
CR	0DH
SOH	01H

• "H" of ASCII code indicates hexa code.

#### 3.2 Command code list

Command code (COM)	Contents
31H	Set temperature (without writing FRAM) and read
32H	Read internal sensor
33H	Read external sensor
34H	Read alarm status
36H	Set offset (without writing FRAM) and read
37H	Set temperature (with writing FRAM)
38H	Set offset (with writing FRAM)

### 3.3 Communication procedures and format

The host computer has the initiative of sequence. Sequence always starts from the host computer and each Thermo-con replies it.

If communication data is processed normally, the Thermo-con returns specified response and if processing communication data is failed, no response is returned.

When no response is returned to the host computer from the Thermo-con even if waiting for 3 sec., resend the data. The Thermo-con returns response after waiting for 50 msec.

For communication of plural number of communication data, wait until the return message is received from the thermo-con to send the next communication data. It sometimes cannot return the messages properly when the communication data is received successively.

#### Selection of Unit Specification

- There are two cases in communication format, which are specifying unit No. and not.
- When one Thermo-con is used, select “without specifying unit” and when two or more Thermo-cons are used, select “ with specifying unit”.
- When several Thermo-con are used with without specified unit No., correct control is not realized due to data conflict.
- In the case of use with specified unit No., ensure to coincide communication No. and each Thermo-con unit No.

#### (1) Setting Change

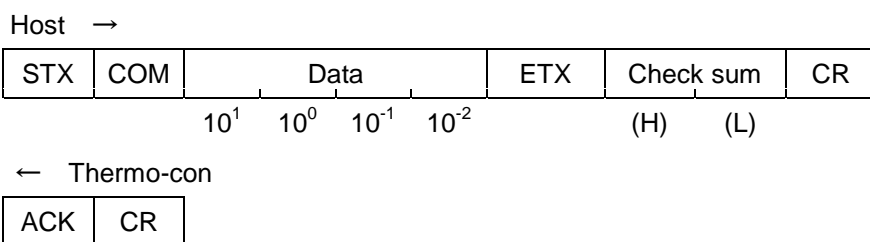

#### <Specifying unit>

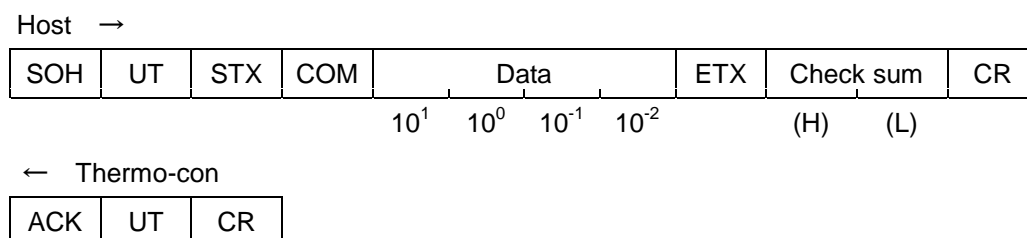

(2) Confirming and reading

Host →

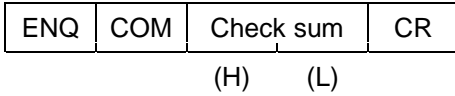

← Thermo-con

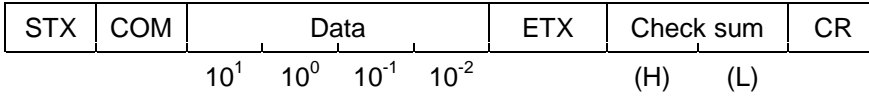

Host →

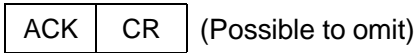

<Specifying unit>

Host →

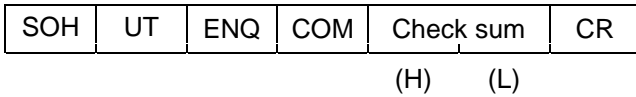

← Thermo-con

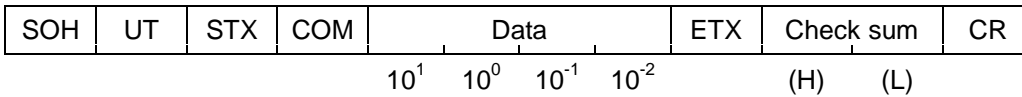

Host →

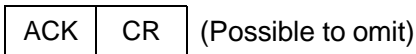

- COM indicates communication command.
- UT indicates unit No. of each Thermo-con. Unit No. is the No. to identify each Thermo-cons when 2 or more Thermo-cons are linked by communication. Set this No. within 0-F. (UT is the code adding 30H to unit No. from 30H to 3FH.)
- As for symbols at communication, minus is indicated by “-” (2DH by ASCII code) and plus is indicated by “0” (30H by ASCII code).
- In case of setting temperature and offset with communication, data out of set range isn’t memorised. (If communication format is correct, ACK returns.)
- When writing in FRAM is specified, changed data is memorized in FRAM each time. FRAM is changed only when data is changed.

### 3.4 Calculation of Check Sum

Calculation range ----- From the second byte to ETX  
 when there is no ETX, add before check sum.

Calculating method-----Take out the lower 1 byte of the total.

eg.) Set temperature to 30 deg.C (without unit specified)

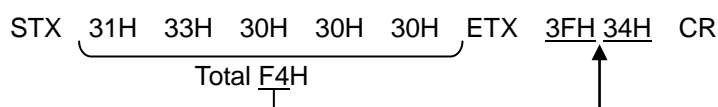

eg.) Read Thermo-con internal sensor of unit No.2

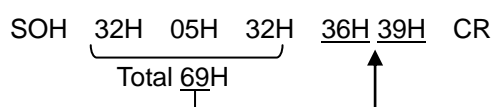

Note) Check sum is not ASCII code.

Data of UT and Check Sum

Character data	0...9	A	B	C	D	E	F
ASCII	30H...39H	41H	42H	43H	44H	45H	46H
UT and check sum	30H...39H(ditto)	3AH	3BH	3CH	3DH	3EH	3FH

## 4 Details of Communication Format

### 4.1 Temperature setting (without writing FRAM)

The host computer sets temperature of each Thermo-con. In this command, temperature setting data is not written in FRAM. This data is invalidated by turning off power.

The setting range is from 10.0 to 60.0 deg.C. As 0.1 deg.C is the minimum unit, the number in the hundredths place ( $10^{-2}$ ) should always be 0 (=30H). (When the value at every 0.01deg.C is input, it is rounded off.)

Host →

STX	31H	Setting data				ETX	Check sum		CR
		$10^1$	$10^0$	$10^{-1}$	$10^{-2}$		(H)	(L)	

← Thermo-con

ACK	CR
-----	----

<Specifying unit>

Host →

SOH	UT	STX	31H	Setting data				ETX	Check sum		CR
				$10^1$	$10^0$	$10^{-1}$	$10^{-2}$		(H)	(L)	

← Thermo-con

ACK	UT	CR
-----	----	----

### 4.2 Reading setting temperature

As 0.1 deg.C is the minimum unit, the number in the hundredths place ( $10^{-2}$ ) is always 0 (=30H).

Host →

ENQ	31H	Check sum		CR
		(H)	(L)	

← Thermo-con

STX	31H	Setting data				ETX	Check sum		CR
		$10^1$	$10^0$	$10^{-1}$	$10^{-2}$		(H)	(L)	

Host →

ACK	CR	(Possible to omit)
-----	----	--------------------

<Specifying unit>

Host →

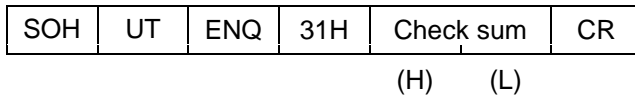

← Thermo-con

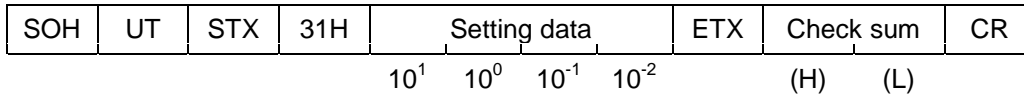

Host →



### 4.3 Reading internal sensor

As the minimum unit is 0.01 deg.C, the value in the hundredths place can be read.

Host →

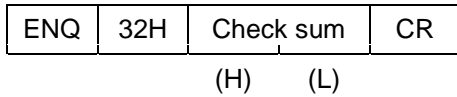

← Thermo-con

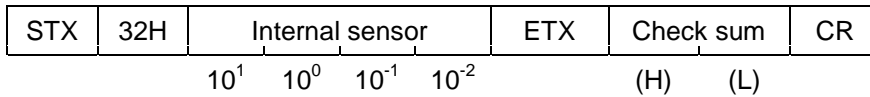

Host →

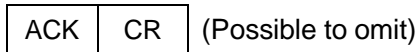

Note) 2DH is entered in  $10^1$  digit “-“ is attached to temperature data.

<Specifying unit>

Host →

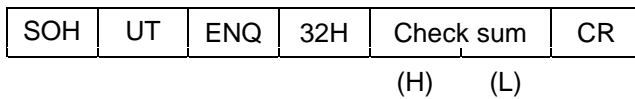

← Thermo-con

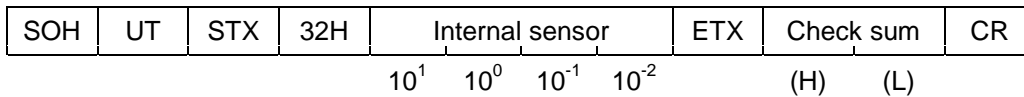

Host →



Note) 2DH is entered in  $10^1$  digit “-“ is attached to temperature data.



## 4.4 Reading external sensor

As the minimum unit is 0.01 deg.C, the value in the hundredths place can be read.

Host →

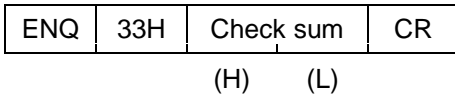

← Thermo-con

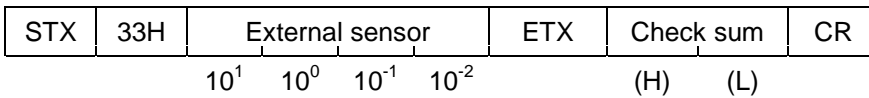

Host →

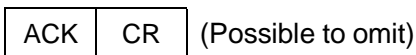

Note) 2DH is entered in  $10^1$  digit "-" is attached to temperature data.

<Specifying unit>

Host →

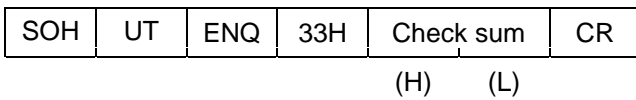

← Thermo-con

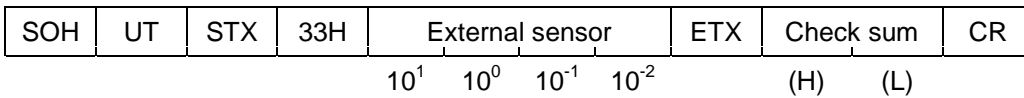

Host →



Note) 2DH is entered in  $10^1$  digit "-" is attached to temperature data.

## 4.5 Reading alarm status

Host →

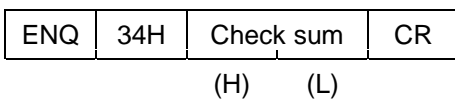

← Thermo-con

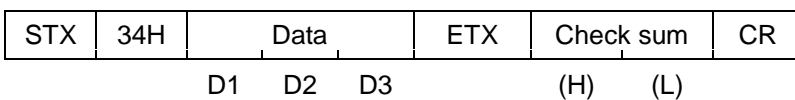

Host →

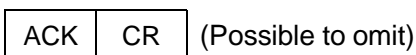

<Specifying unit>

Host →

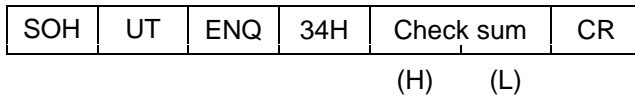

← Thermo-con

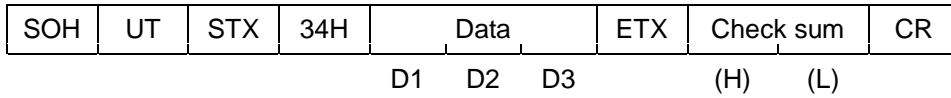

Host →



Data (D2, D2, D3) changes following bit line to ASCII code. (1 is for ON, 0 is for OFF)

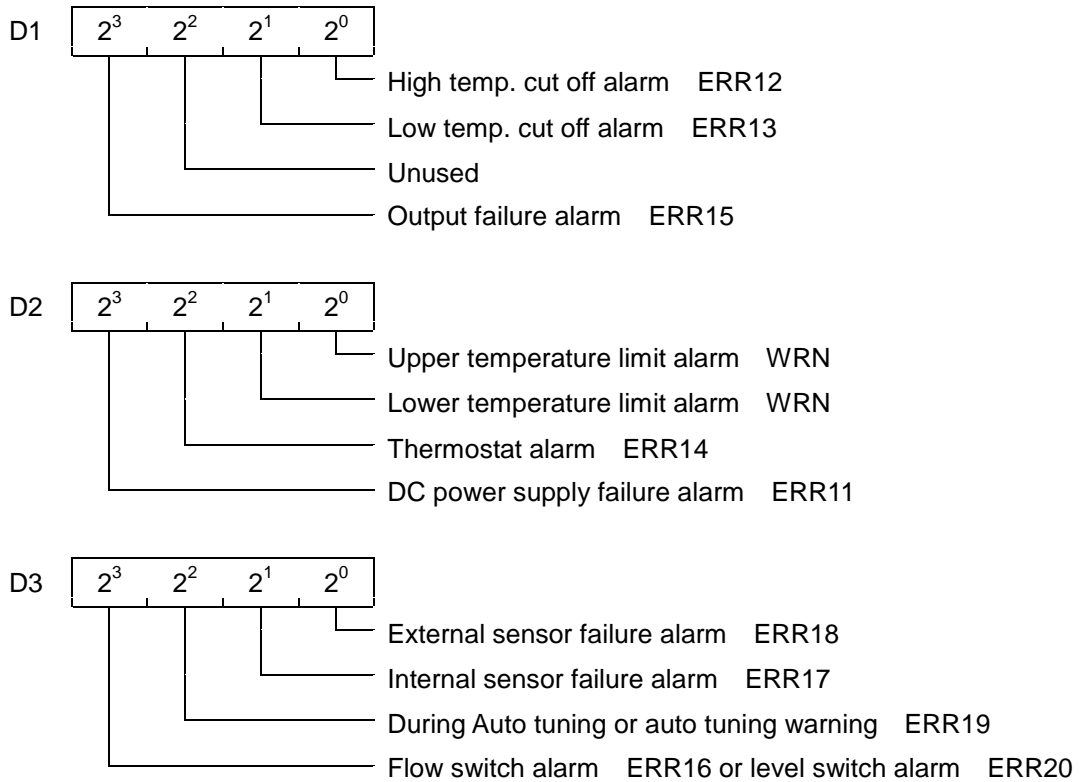

When some alarms/warnings go off at the same time, D1 to D3 reaches the added value.

Ex. When the “Upper temperature limit alarm” and the “DC power voltage alarm” go off simultaneously, D2 will be  $23 \times 1 + 22 \times 0 + 21 \times 0 + 20 \times 1 = 9 (=39H)$ .

## 4.6 Offset setting (without writing FRAM)

Set offset of each Thermo-con from host. In this command, offset data loses effect with turning power to OFF because it isn't memorized into FRAM.

It can be set at a minimum of every 0.01 deg.C.

Host →

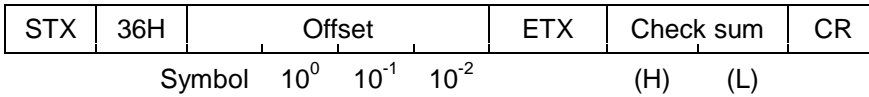

← Thermo-con

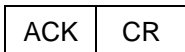

Note) As for symbols, minus is indicated by “-“(=2DH) and plus is indicated by “0”(=30H).

Host →

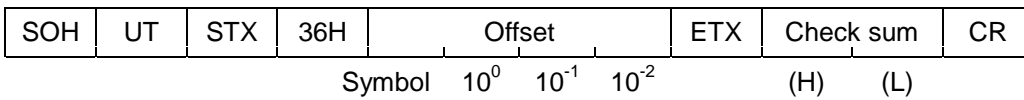

← Thermo-con

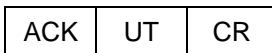

Note) As for symbols, minus is indicated by “-“(=2DH) and plus is indicated by “0”(=30H).

## 4.7 Reading offset

As the minimum unit is 0.01 deg.C, the value in the hundredths place can be read.

Host →

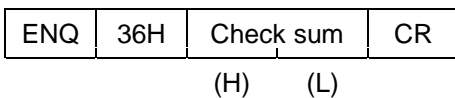

← Thermo-con

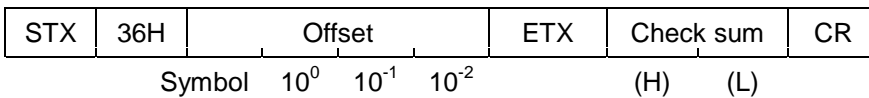

Host →

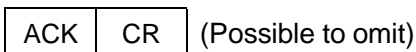

Note) As for symbols, minus is indicated by “-“(=2DH) and plus is indicated by “0”(=30H).

<Specifying unit>

Host →

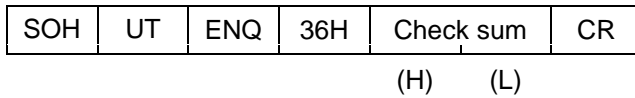

← Thermo-con

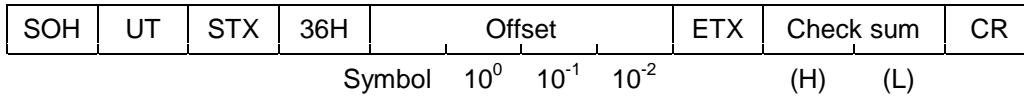

Host →



Note) As for symbols, minus is indicated by “-”(=2DH) and plus is indicated by “0”(=30H).

### 4.8 Temperature setting (with writing FRAM)

The host computer sets temperature of each Thermo-con. In this command, temperature setting data is written in FRAM.

The setting range is from 10.0 to 60.0 deg.C. As 0.1 deg.C is the minimum unit, the number in the hundredths place (10<sup>-2</sup>) should always be 0 (=30H). (When the value at every 0.01deg.C is input, it is rounded off.)

Host →

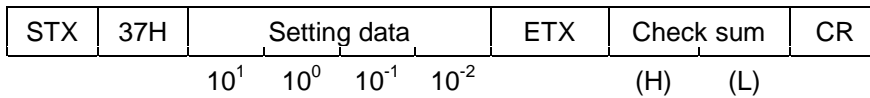

← Thermo-con

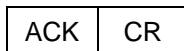

<Specifying unit>

Host →

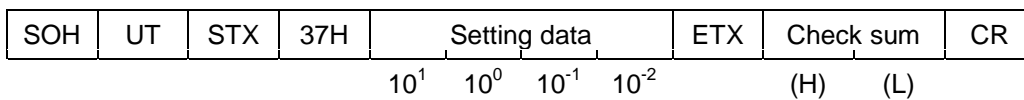

← Thermo-con

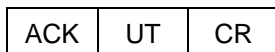

### 4.9 Offset setting (with writing FRAM)

Set offset of each Thermo-con from host. In this command, offset data is memorized into FRAM.

It can be set at every minimum unit of +/-0.01 deg.C.

Host →

STX	38H	Offset			ETX	Check sum		CR
	Symbol	10 <sup>0</sup>	10 <sup>-1</sup>	10 <sup>-2</sup>		(H)	(L)	

← Thermo-con

ACK	CR
-----	----

Note) As for symbols, minus is indicated by “-“(=2DH) and plus is indicated by “0”(=30H).

Host →

SOH	UT	STX	38H	Offset			ETX	Check sum		CR
			Symbol	10 <sup>0</sup>	10 <sup>-1</sup>	10 <sup>-2</sup>		(H)	(L)	

← Thermo-con

ACK	UT	CR
-----	----	----

Note) As for symbols, minus is indicated by “-“(=2DH) and plus is indicated by “0”(=30H).

## 4.10 Communication Format and Examples of Answers from Thermo-con

Examples of commands and answers from the thermo-con (unit unspecified)

Command code ASCII	Command	Unit specified	Host requirement (ASCII code)	Answer from thermo-con (ASCII code)	Content
31	Reading setting temperature	No	05 31 33 31 0D	02 31 32 35 30 30 03 3F 38 0D	Answer "25.0 deg.C."
31	Temperature setting (without writing FRAM)	No	02 31 32 35 30 30 03 3F 38 0D	06 0D	Set at 25.0 deg.C
32	Reading internal sensor	No	05 32 33 32 0D	02 32 32 35 30 32 03 3F 3B 0D	Answer "25.02 deg.C"
33	Reading external sensor	No	05 33 33 33 0D	02 33 33 30 30 32 03 3F 38 0D	Answer "30.02 deg.C"
34	Reading alarm status	No	05 34 33 34 0D	02 34 30 38 30 03 3C 3C 0D	Answer "ERR11"
36	Reading offset	No	05 36 33 36 0D	02 36 2D 31 35 32 03 3F 3B 0D	Answer "-1.52 deg.C"
	Offset setting (without writing FRAM)	No	02 36 30 31 35 30 03 3F3C 0D	06 0D	Set at +1.50 deg.C
37	Temperature setting (with writing FRAM)	No	02 37 32 35 30 30 03 3F3E 0D	06 0D	Set at 25.0 deg.C
38	Offset setting (with writing FRAM)	No	02 38 30 31 35 30 03 3F3E 0D	06 0D	Set at +1.50 deg.C

Examples of commands and answers from the thermo-con (unit specified)

Command code ASCII	Command	Unit specified	Host requirement (ASCII code)	Answer from thermo-con (ASCII code)	Content
31	Reading setting temperature	2	01 32 05 31 36 38 0D	01 32 02 31 32 35 30 30 03 32 3C 0D	Answer "25.0 deg.C"
31	Temperature setting (without writing FRAM)	2	01 32 02 31 32 35 30 30 03 32 3C 0D	06 32 0D	Set at 25.0 deg.C
32	Reading internal sensor	2	01 32 05 32 36 39 0D	01 32 02 32 32 35 30 32 03 32 3F 0D	Answer "25.02 deg.C"
33	Reading external sensor	2	01 32 05 33 36 3A 0D	01 32 02 33 33 30 30 32 03 32 3C 0D	Answer "30.02 deg.C"
34	Reading alarm status	2	01 32 05 34 36 3B 0D	01 32 02 34 30 38 30 03 30 30 0D	Answer "ERR11"
36	Reading offset	2	01 32 05 36 36 3D 0D	01 32 02 36 2D 31 35 32 03 32 3F 0D	Answer "-1.52 deg.C"
	Offset setting (without writing FRAM)	2	01 32 02 36 30 31 35 30 03 33 30 0D	06 32 0D	Set at +1.50 deg.C
37	Temperature setting (with writing FRAM)	F	01 3F 02 37 32 35 30 30 03 33 3F 0D	06 3F 0D	Set at 25.0 deg.C
38	Offset setting (with writing FRAM)	F	01 3F 02 38 30 31 35 30 03 33 3F 0D	06 3F 0D	Set at +1.50 deg.C

## 5 MODBUS communication function

MODBUS protocol is a communication protocol developed by Modicon. It is used to communicate with a PC or PLC.

Register content is read and written by this communication protocol.

This communication has the following features.

- Control run/stop.
- Set temperature and read.
- Read the internal sensor.
- Read the external sensor.
- Read the condition of the product.
- Read the alarm generating condition of the product.
- Read and set the control parameter(PID values).

Refer to “5.10 Register Map” for the register of the product.

### 5.1 Precautions for communication

#### 5.1.1 Precautions after wiring and before communication

- 1) Check or set the each communication setting by the operation display panel.
  - The communication specification shall be the customer’s communication standard (RS-485 or RS-232C).
  - The serial protocol shall be the MODBUS.
  - The communication mode shall be the SeriRem (Serial remote mode).  
Other modes can perform reading, but only SERIAL mode can perform writing.
- 2) Check or set the communication parameters using the operation display panel.  
Check or set the communication speed so that the product synchronizes with the host computer (master) prepared by the customer.
- 3) Check the slave address (unit number) by the operation display panel.  
No response is returned when a request message is sent from a slave address other than those set in the product.

#### 5.1.2 Precautions for communicating

- 1) Allow a suitable interval between requests.  
To send request messages in series, wait for 50 msec. or longer after receiving a response message from the product before sending the next message.
- 2) Retry (resend request message).  
The response may not be returned due to noise. If no message is returned 3sec. after sending a request message, resend the request message.

- 3) If necessary send a read request message to check if it was written correctly.  
 Message to notify the completion of the process is returned when the action for the written request message is completed.  
 Send a read request message to confirm if the setting was written as requested.
- 4) Setting limit of circulating fluid temperature  
 When the circulating fluid set temperature is written by communication, the data is stored in FRAM. When the product restarts, it restarts with the value which was set before the restart. The number of times it is possible to overwrite FRAM is limited. Data is only stored in FRAM when it receives a circulating fluid set temperature which is different from the previous temperatures. Please check how many times it is possible to overwrite FRAM, and avoid unnecessary changes of the circulating fluid set temperature during communication

## 5.2 Communication specification

Refer to chapter 2 in regard to communication protocol.

- Protocol ..... Modbus
- Master / Slave ..... Slave
- Letter code ..... ASCII
- Slave address (Unit number) ..... Select from 01H to 0FH
- Function code ..... 03H, 06H, 10H, 17H
- Error check ..... LRC method
- Data transfer direction ..... LSB

## 5.3 Setting and checking

### 5.3.1 List of Items to be Set and Checked

The table below explains the setting options of the MODBUS communication function.

Item	Explanation
Interface	Select RS-485 or RS-232C
RS-485 terminal unit	Set the terminal unit for RS-485
Communication protocol	Set the serial communication protocol
Control mode	Set the control mode of the product. Serial remote mode (SeriRem) can be selected by setting the communication protocol to Modbus.
Slave address (Unit No.)	Set the slave address (Unit No.) of the unit
Communication speed	Set the communication speed of the Modbus protocol



### ■ Product set up procedure

The communication protocol is a command based protocol using the Modbus protocol. The communication will be available for sending the communication commands after setting up the product.

#### 1) Select communication protocol

- Select Set Mode Level 3 by pressing the "SEL" and "Δ" buttons, then select RS-485 or RS-232C.
- If RS-485 is selected, set resistance of the terminating resistor.
- Press the "SEL" button once to display "Unit number", and select slave address (1H to 0FH) by pressing the "Δ" button (Unit 0 cannot be used).
- Press the "SEL" button and set the baud rate, parity, data length and stop bit with the "Δ" or "∇" button.
- Press the "SEL" button twice to display "Communication Protocol", and select "Modbus" by pressing the "Δ" button.

#### 2) Setting of the control mode

- Select Set Mode Level 1, and press the "SEL" button twice to display "Control Operation". Then, select "5. SeriRem" (Serial remote mode).  
When this mode is selected, the thermo-con stops the operation at once. Also, the set value is not able to be changed with the control panel when this mode is selected.

#### 3) Send command

In the serial remote mode, the control operation, etc of the thermo-con can be set by sending the communication commands.

## 5.4 Communication sequence

Starts with a request message from the customer's system (host), and finishes with a response message from the product (slave). This product operates as a slave. It does not send any requests.

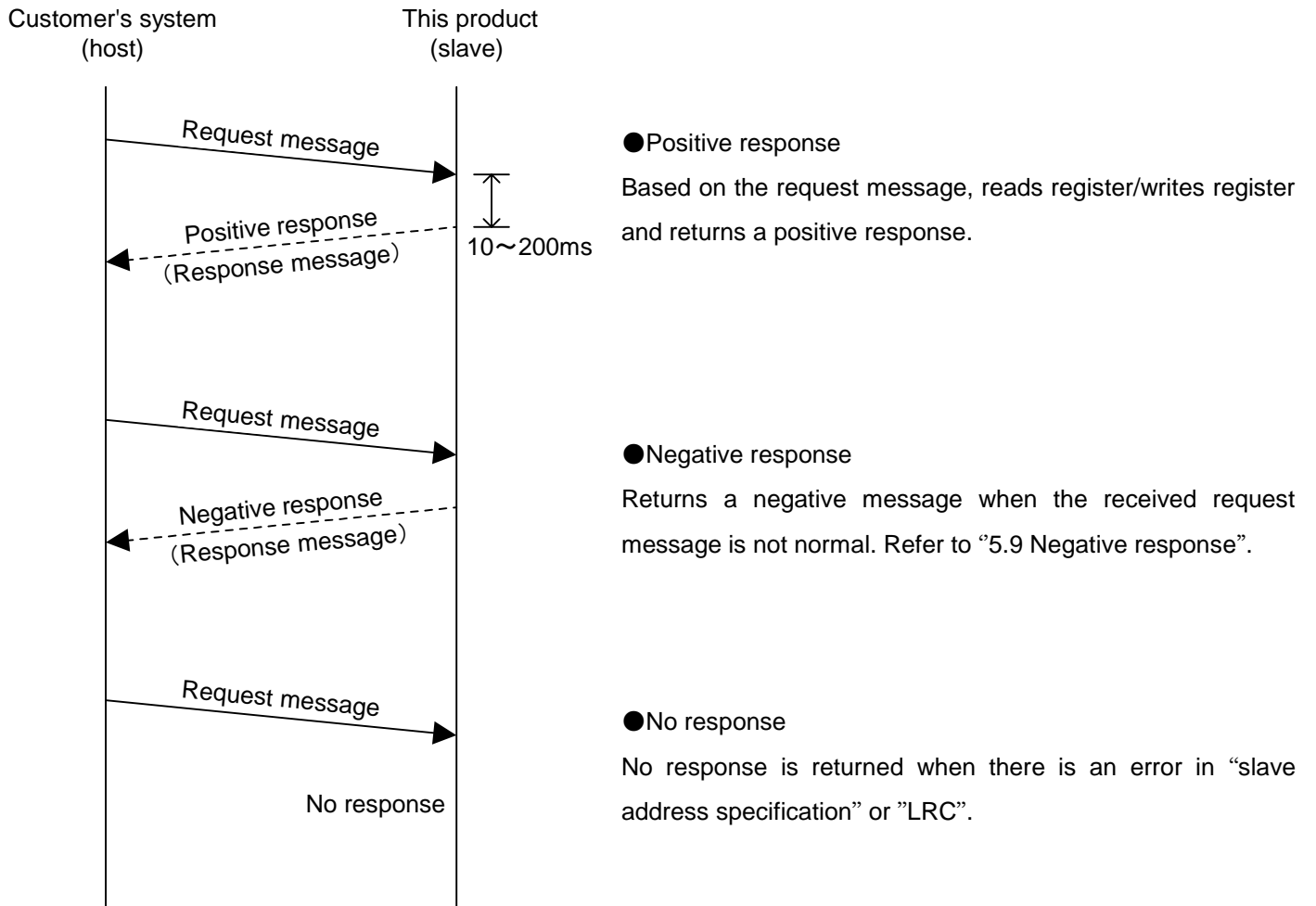

## 5.5 Message configuration

### 5.5.1 Message format

The message configuration is shown below. This product communicates in ASCII mode. ASCII mode is used from Start to End.

1)	2)		3)		4)			5)		6)	
Start	Slave Address		Function		Data			LRC		End	
[:]	XX	XX	XX	XX	XX	~	XX	XX	XX	[CR]	[LF]

1) Start

The start of the message. [:] (3AH)

2) Slave Address (=Unit number) (01H to 0FH 3031 to 3046)

This is a number to identify this product. "1" is the default setting. This can be changed by the operation display panel.

3) Function (Refer to "5.6 Function codes".)

Command is assigned.

4) Data

Depending on the function, the address and the number of the register, the value of reading/writing are assigned.

5) LRC

LRC method

Refer to "5.7 LRC".

6) END

The end of the message. [CR] (0DH) + [LF] (0AH)

A response message will not be returned unless the request includes [:] and [CR] [LF].

This product clears all previously received code when [:] is received.

### 5.5.2 Message example

The example shows communication with the conditions below.

- 1) Slave Address (=Unit number): No.1
- 2) Read a data from register 0040H.  
(Read Internal sensor temperature.)

■ Communication example

**CAUTION**



**The communication example is expressed in hexadecimal value with [ ]. The actual communication is performed in ASCII code. Refer to the request / response message in this section.**

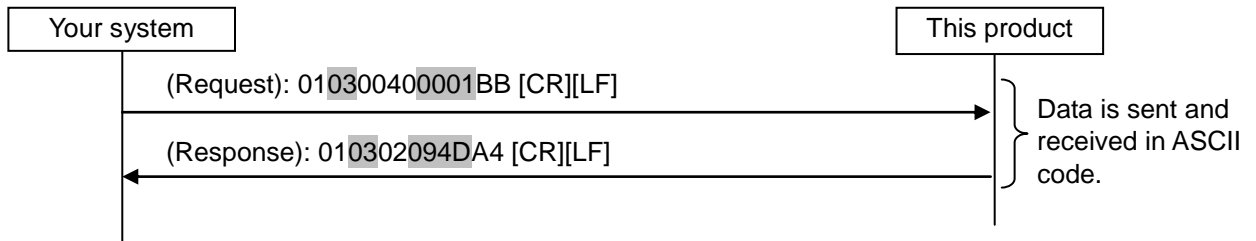

Request message		Response message	
Code	Contents	Code	Contents
01	Slave Address	01	Slave Address
03	Function	03	Function
0040	Head address of specified register	02	Quantity of bytes to read
0001	Quantity of register to read	094D	Information of 0040H (circulating fluid discharge temperature: 23.81°C)
BB	LRC	A4	LRC

■ Request message (Master to Slave)

Start	Slave Address		Function		Data				LRC		End	
3A	30	31	30	33					42	42	0D	0A

Read Address				Quantity to Read			
Hi		Lo		Hi		Lo	
30	30	34	30	30	30	30	31

■ Response message (Slave to Master)

Start	Slave Address		Function		Data				LRC		End	
3A	30	31	30	33					41	34	0D	0A

Byte Count		Read Data1					
		Hi			Lo		
30	32	30	39	34	4D		

## 5.6 Function codes

The table below function codes to read or write register.

NO	Code	Name	Function
1	03(03H)	Read holding registers	Reading multiple registers
2	06(06H)	Preset single register	Writing registers <sup>*1</sup>
3	16(10H)	Preset multiple registers	Writing multiple registers
4	23(17H)	Read/write 4x registers	Reading/writing multiple registers

\*1: Broadcast is not supported.

## 5.7 LRC

LRC checks the content of the message other than [:] of START and [CR][LF] of END. The sending side calculates and sets. The receiving side calculates based on the received message, and compares the calculation result with the received LRC. The received message is deleted if the calculation result and received LRC do not match.

Add up the byte number of the message consisting of 8 consecutive bits. The result except the carry (overflow) is converted to 2's complement.

### ■ Calculation example

LRC message for calculation	0106000B00FE
Calculation	1) Addition $01H+06H+00H+0BH+00H+FEH=110H$ 2) Object $110H \rightarrow 10H$ 3) complement of 2 $10H \rightarrow EFH \rightarrow F0H$ LRC is F0H
Sending message	[:]0106000B00FEF0[CR][LF]

## 5.8 Explanation of function codes

### 5.8.1 Function code : 03H Reading multiple registers

Register data of assigned points from assigned address is read.

■ Request message <Normal> (Master to Slave)

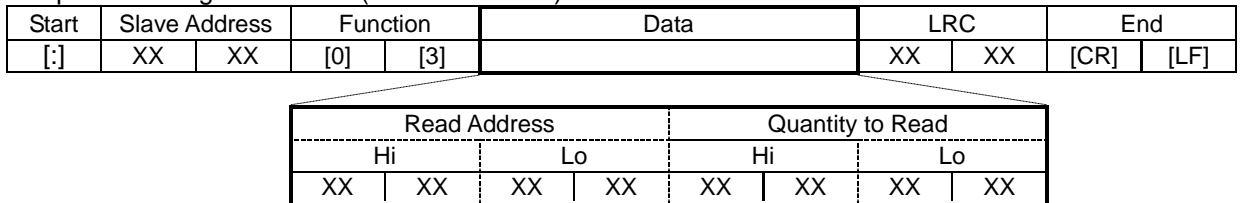

■ Response message<Normal> (Slave to Master)

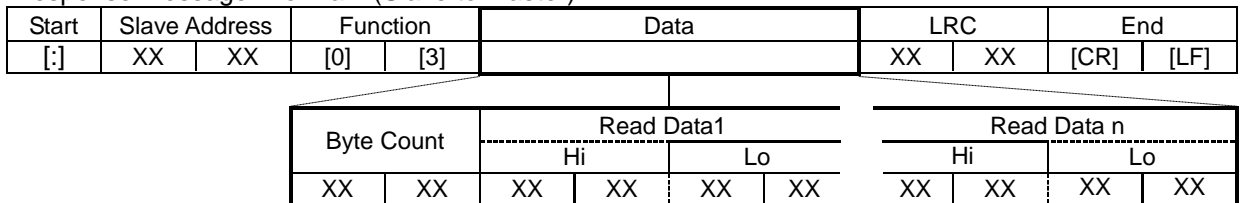

■ Communication example

1) Slave Address (=Unit number): No.1

2) Read three consecutive data from register 0040H.

(Read internal sensor temperature, external sensor temperature, average temperature.)

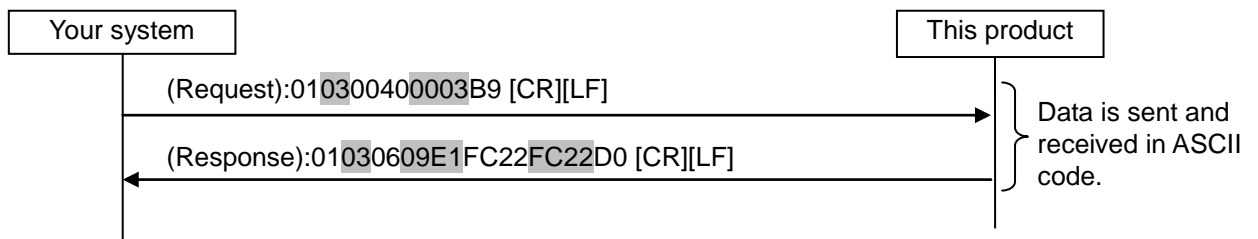

Request message		Response message	
Code	Contents	Code	Contents
01	Slave Address	01	Slave Address
03	Function	03	Function
0040	Head address of specified register	06	Quantity of bytes to read
0003	Quantity of register to read	09E1	Information of 0040H (internal sensor temperature)
B9	LRC	FC22	Information of 0041H (external sensor temperature)
		FC22	Information of 0042H (average temperature=external temperature)
		D0	LRC

### 5.8.2 Function code : 06H Writing registers

Write data to assigned address.

■ Request message <Normal> (Master to Slave)



■ Response message <Normal> (Slave to Master)

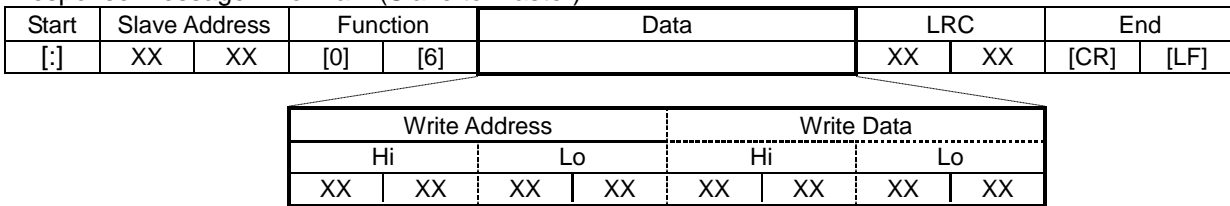

■ Communication example

1) Slave Address (=Unit number): No 1

2) Write data to register 0050H

(Commands to run)

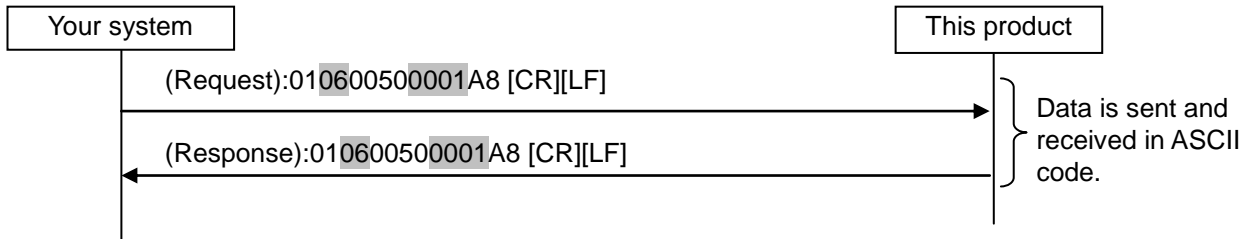

Request message		Response message	
Code	Contents	Code	Contents
01	Slave Address	01	Slave Address
06	Function	06	Function
0050	Address of specified register	0050	Address of register to write
0001	Information written to 0050H (Stop flag)	0001	Information of register to write
A8	LRC	A8	LRC

### 5.8.3 Function code : 10H Writing multiple registers

Register content of assigned points of assigned address is written.

■ Request message <Normal> (Master to Slave)

Start	Slave Address		Function		Data	LRC		End	
[:]	XX	XX	[1]	[0]		XX	XX	[CR]	[LF]

Write Address				Quantity to Write			
Hi		Lo		Hi		Lo	
XX	XX	XX	XX	XX	XX	XX	XX

Byte Count		Write Data1				Write Data n			
		Hi		Lo		Hi		Lo	
XX	XX	XX	XX	XX	XX	XX	XX	XX	XX

■ Response message <Normal> (Slave to Master)

Start	Slave Address		Function		Data	LRC		End	
[:]	XX	XX	[1]	[0]		XX	XX	[CR]	[LF]

Write Address				Quantity to Write			
Hi		Lo		Hi		Lo	
XX	XX	XX	XX	XX	XX	XX	XX

■ Communication example

1) Slave Address (=Unit number): No 1

2) Write two consecutive data from register 0051H.

(Commands to change of target temperature (=30.0°C) and offset temperature (=0.50°C))

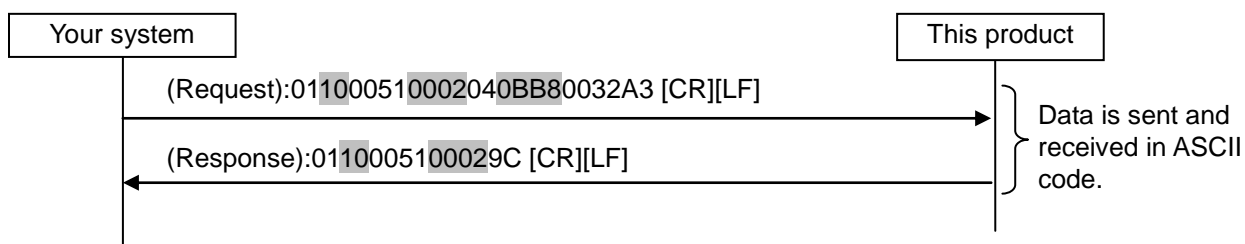

Request message		Response message	
Code	Contents	Code	Contents
01	Slave Address	01	Slave Address
10	Function	10	Function
0051	Head address of specified register	0051	Head address of register to write
0002	Quantity of register to write	0002	Quantity of register to write
04	Quantity of byte to read	9C	LRC
0BB8	Information written to 0051H (Target temperature)		
0032	Information written to 0052H (Offset temperature)		
A3	LRC		



### 5.8.4 Function code : 17H Reading/writing multiple registers

Register content of assigned points of assigned address is read. Write the register data from the specified address with specified points simultaneously.

■ Request message <Normal> (Master to Slave)

Start	Slave Address		Function		Data				LRC		End	
[:]	XX	XX	[1]	[7]					XX	XX	[CR]	[LF]

Read Address				Quantity to Read				Write Address				Quantity to Write			
Hi		Lo		Hi		Lo		Hi		Lo		Hi		Lo	
XX	XX	XX	XX	XX	XX	XX	XX	XX	XX	XX	XX	XX	XX	XX	XX

Byte Count		Write Data1				Write Data n			
		Hi		Lo		Hi		Lo	
XX	XX	XX	XX	XX	XX	XX	XX	XX	XX

■ Response message <Normal> (Slave to Master)

Start	Slave Address		Function		Data				LRC		End	
[:]	XX	XX	[1]	[7]					XX	XX	[CR]	[LF]

Byte Count		Read Data1				Read Data n			
		Hi		Lo		Hi		Lo	
XX	XX	XX	XX	XX	XX	XX	XX	XX	XX

■ Communication example

- 1) Slave Address (=Unit number): No 1
- 2) Read three consecutive data from register 0040H, and write two consecutive data from register 0051h.  
(Command to read the internal sensor temperature, external sensor temperature and average temperature and change the target temperature to <30.0°C>, offset temperature to <0.50°C >)

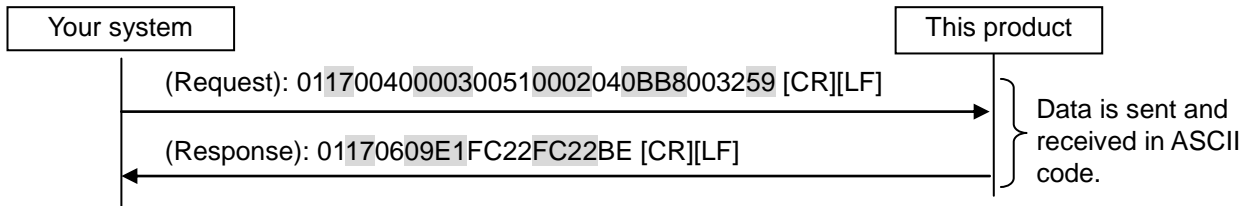

Request message		Response message	
Code	Contents	Code	Contents
01	Slave Address	01	Slave Address
17	Function	17	Function
0040	Head address of specified register	06	Quantity of byte to read
0003	Quantity of register to read	09E1	Information of 0040H (Internal sensor temperature)
0051	Head address of specified register	FC22	Information of 0041H (External sensor temperature)
0002	Quantity of register to write	FC22	Information of 0042H (Average temperature)
04	Quantity of byte to read	BE	LRC
0BB8	Information written to 0051H (Target temperature)		
0032	Information written to 0052H (Offset temperature)		
59	LRC		

## 5.9 Negative response

A negative response is returned when the following request message is received.

- 1) When unspecified function code is used.
- 2) An address out of range is specified.
- 3) The data field is not normal.

■ Negative response message (Slave to Master)

Start	1)		2)		Error cODE		LRC		End	
	Slave Address	Function	Function	Function						
[:]	XX	XX	[0]	[3]	XX	XX	XX	XX	[CR]	[LF]

1) Function

Assign the value consisting of the request function code (hexadecimal value) plus 80H in ASCII code.

2) Error Code

Assign error code below.

- 01: Function code of a command is outside the standard
- 02: The specified address of register is outside the range.
- 03: Data field of a command is not normal.

■ Communication example

1) Slave Address (=Unit number): No 1

2) Read seven consecutive data from register 0100H which is out of range.

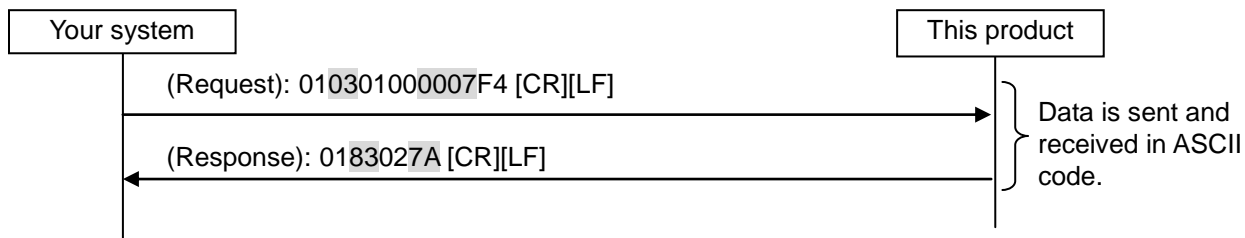

Request message		Response message	
Code	Contents	Code	Contents
01	Slave Address	01	Slave Address
03	Function	83	Function (03H+80H)
0100	Head address of register out of range	02	Error Code (Specified register address is out of range.)
0007	Quantity of register to read	7A	LRC
F4	LRC		

## 5.10 Register Map

Address	Bit Format															R/W
	15	14	13	12	11	10	9	8	7	6	5	4	3	2	1	
0040h	Internal sensor temperature -9.90 to 80.00°C = FC22H to 1F40H															R
0041h	External sensor temperature -9.90 to 80.00°C = FC22H to 1F40H															
0042h	Average temperature -9.90 to 80.00°C = FC22H to 1F40H															
0043h	Status flag See chapter 5.10.1															
0044h	Alarm flag 1 See chapter 5.10.2															
0045h	Alarm flag 2 See chapter 5.10.2															
0046h	Output ratio -100% to 100% = FF9CH to 0064H															
0050h	Control operation See chapter 5.10.3															R/W
0051h	Target temperature 10 to 60.0°C = 03E8H to 1770H *1)															
0052h	Offset value -9.99 to 9.99°C = FC19H to 03E7H															
0053h	PB range 0.30 to 9.90°C = 001EH to 03DEH *1)															
0054h	Reserved															
0055h	I constant 1 to 999 sec = 0001H to 03E7H															
0056h	D constant 0.00 to 99.90 sec = 0000H to 2706H *1)															
0057h	Heat output limit 0 to 100% = 0000H to 0064H															
0058h	Cool output limit -100 to 0% = FF9CH to 0000H															

\*1: Rounded off to the second decimal place.

### 5.10.1 Status flag

The status of the product is read by the following assignment.

Name	Status flag															
Bit	15	14	13	12	11	10	9	8	7	6	5	4	3	2	1	0

Bit	Name	Explanation
0	Run flag	Run status 0= Stop 1=Run
1	Alarm flag	Alarm status 0= Not occurred 1=Occurred
2	Warning flag	Warning status 0= Not occurred 1=Occurred
3-15	Unused	

### 5.10.2 Alarm flag

Each type of alarm which occurs in the product is read with the following assignment.

Name	Alarm flag 1,2															
Bit	15	14	13	12	11	10	9	8	7	6	5	4	3	2	1	0

Bit	Name	Explanation	
Alarm flag 1	0	Unused	Alarm given off status 0= Not occurred 1= Occurred
	1	ERR01 System error 1	
	2	ERR02 System error 2	
	3	ERR03 Back-up data error	
	4-10	Unused	
	11	ERR11 DC power supply failure	
	12	ERR12 Internal temperature sensor High temperature failure	
	13	ERR13 Internal temperature sensor Low temperature failure	
	14	ERR14 Thermostat alarm	
	15	ERR15 Abnormal output alarm	
Alarm flag 1	0	ERR16 Low circulating flow rate alarm (option)	
	1	ERR17 Internal temperature sensor disconnection alarm	
	2	ERR18 External temperature sensor disconnection alarm	
	3	ERR19 Abnormal auto tuning alarm	
	4	ERR20 Low fluid level alarm	
	5-11	Unused	
	12	WRN Temperature upper limit	
	13	WRN Temperature lower limit	
	14	Unused	
	15	Unused	

### 5.10.3 Control operation mode

The control operation mode is assigned as follows.

Name	Alarm flag 1															
Bit	15	14	13	12	11	10	9	8	7	6	5	4	3	2	1	0

Bit	Name	Explanation
0-2	Operation mode	0=Pump stop 1=Normal operation (Run) 2=Auto tuning start 3=Learning control 4=External tune control
3-15	Unused	-

The operation mode with Modbus communication is displayed as the figure on the right (Mode 0 = Operation stopped).

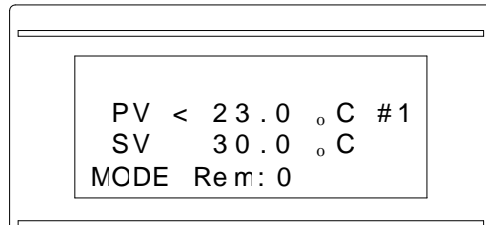

### 5.10.4 Circulating fluid set temperature

The circulating fluid set temperature can be set by specifying the circulating fluid target temperature during Serial Remote mode.

If the temperature exceeds the upper limit of the circulating fluid set temperature range, the circulating fluid target temperature is changed to the upper limit value. If it is lower than the lower limit, the circulating fluid set temperature is changed to the lower limit value.

### 5.10.5 Setting of control mode

The operation can be controlled by sending the operation start command during Serial Remote mode.

0=Stop 1=Start

### 5.10.6 Setting of the Upper Limit of the Output

The upper limit of the output can be set to restrict the power consumption. The power consumption is reduced by 50% by setting the upper limit of heating to 50%.

## 5.11 Communication Format and Examples of Answers from Thermo-con

Examples of commands and answers from the thermo-con

Address	Command	Slave address	Host requirement (Character)	Answer from thermo-con (Character)	Content
0040	Reading internal sensor temperature	1	:01 03 0040 0001 BB [CR][LF]	:01 03 02 09E1 10 [CR][LF]	Answer "25.29 deg.C."
0041	Reading external Sensor temperature	1	:01 03 0041 0001 BA [CR][LF]	:01 03 02 09E1 10 [CR][LF]	Answer "25.29 deg.C."
0043	Reading status	1	:01 03 0043 0001 B8 [CR][LF]	:01 03 02 0005 F5 [CR][LF]	Run with alarm
0044	Alarm flag 1	1	:01 03 0044 0001 B7 [CR][LF]	:01 03 02 8000 7A [CR][LF]	ERR15
0050	Control operation mode	1	:01 06 0050 0000 A9 [CR][LF]	:01 06 0050 0000 A9 [CR][LF]	Stop
			:01 06 0050 0001 A8 [CR][LF]	:01 06 0050 0001 A8 [CR][LF]	Start
0051	Temperature setting	1	:01 06 0051 0BB8 E5 [CR][LF]	:01 06 0051 0BB8 E5 [CR][LF]	Set at 30.0 deg.C.
0052	Offset setting	1	:01 06 0052 0032 75 [CR][LF]	:01 06 0052 0032 75 [CR][LF]	Set at 0.50 deg.C.

## 6 Troubleshooting

The table below shows the solutions for the problems.

Problem	Cause	Solution
Communication cannot be made.	A wrong connecting cable is used.	Connect the host and the thermo-con with the following cables: A straight cable for RS-485 A cross cable for RS-232C
	The settings of the host and thermo-con are not consistent with each others.	Make the following settings of the host and the thermo-con consistent: Unit Number, Baud Rate, Parity Bit, Data Length, Stop Bit
	The program is incorrect.	Ensure that the program is made properly according to this operation manual. (Control code, command code, checksum, etc.)
	The communication method is incorrect.	Use the communication method suitable for the specification of the thermo-con (RS-485, RS-232C).
	It is influenced by the noise from outside.	Use a shield wire for the cable, and ground the shield to the field ground.
	It is influenced by the reflected wave.	Set a terminating resistance.
Temperature cannot be set.	Four digits are not input for the setting temperature.	Input four digits for the setting temperature. As 0.1 deg.C is the minimum indication unit, input 0 (=30H) in the hundredths place.
	Value out of the setting range is input.	Set it within the temperature setting range (between 10.0 and 60.0 deg.C).
Communication cannot be continued.	The connecting cable comes off or broken.	Check the connecting cable.
The thermo-con does not give a correct answer.	The host sends more than one communication data successively.	When sending communication data, wait until an answer from the thermo-con is received to send the next data.