



# Operation Manual

PRODUCT NAME

Air cylinder

MODEL / Series / Product Number

C \* M2 \* \* - \* AZ

C \* M2 \* \* - \* AZ - XC85

C \* M2 \* \* - \* AZ - X446

**SMC Corporation**

# Contents

Safety Instructions	P2
1. Specifications	P4
1-1. Specifications	
2. Installation and Handling	P4
2-1. Air supply	
2-2. Design	
2-3. Mounting and Installation	
2-4. Environment	
2-5. Speed control	
2-6. Air cushion	
2-7. Control of direction	
2-8. Auto switches	
3. Maintenance	P19
3-1. Replacement of rod seal	
3-2. Checks	
3-3. Consumable parts	
4. Made to order product (XC85, X446)	P22
4-1. Food Machinery Grease Specification	
4-2. PTFE Grease Specification	
5. Basic Circuit for Cylinder Operation	P23
6. Troubleshooting	P24
7. Construction	P27



# Safety Instructions

These safety instructions are intended to prevent hazardous situations and/or equipment damage. These instructions indicate the level of potential hazard with the labels of "Caution," "Warning" or "Danger." They are all important notes for safety and must be followed in addition to International Standards (ISO/IEC)<sup>\*1)</sup>, and other safety regulations.

\*1) ISO 4414: Pneumatic fluid power -- General rules relating to systems.

ISO 4413: Hydraulic fluid power -- General rules relating to systems.

IEC 60204-1: Safety of machinery -- Electrical equipment of machines .(Part 1: General requirements)

ISO 10218-1992: Manipulating industrial robots -Safety.

etc.



## Caution

**Caution** indicates a hazard with a low level of risk which, if not avoided, could result in minor or moderate injury.



## Warning

**Warning** indicates a hazard with a medium level of risk which, if not avoided, could result in death or serious injury.



## Danger

**Danger** indicates a hazard with a high level of risk which, if not avoided, will result in death or serious injury.

## Warning

### **1. The compatibility of the product is the responsibility of the person who designs the equipment or decides its specifications.**

Since the product specified here is used under various operating conditions, its compatibility with specific equipment must be decided by the person who designs the equipment or decides its specifications based on necessary analysis and test results.

The expected performance and safety assurance of the equipment will be the responsibility of the person who has determined its compatibility with the product.

This person should also continuously review all specifications of the product referring to its latest catalog information, with a view to giving due consideration to any possibility of equipment failure when configuring the equipment.

### **2. Only personnel with appropriate training should operate machinery and equipment.**

The product specified here may become unsafe if handled incorrectly.

The assembly, operation and maintenance of machines or equipment including our products must be performed by an operator who is appropriately trained and experienced.

### **3. Do not service or attempt to remove product and machinery/equipment until safety is confirmed.**

1. The inspection and maintenance of machinery/equipment should only be performed after measures to prevent falling or runaway of the driven objects have been confirmed.

2. When the product is to be removed, confirm that the safety measures as mentioned above are implemented and the power from any appropriate source is cut, and read and understand the specific product precautions of all relevant products carefully.

3. Before machinery/equipment is restarted, take measures to prevent unexpected operation and malfunction.

### **4. Contact SMC beforehand and take special consideration of safety measures if the product is to be used in any of the following conditions.**

1. Conditions and environments outside of the given specifications, or use outdoors or in a place exposed to direct sunlight.

2. Installation on equipment in conjunction with atomic energy, railways, air navigation, space, shipping, vehicles, military, medical treatment, combustion and recreation, or equipment in contact with food and beverages, emergency stop circuits, clutch and brake circuits in press applications, safety equipment or other applications unsuitable for the standard specifications described in the product catalog.

3. An application which could have negative effects on people, property, or animals requiring special safety analysis.

4. Use in an interlock circuit, which requires the provision of double interlock for possible failure by using a mechanical protective function, and periodical checks to confirm proper operation.



# Safety Instructions

## Caution

### **1. The product is provided for use in manufacturing industries.**

The product herein described is basically provided for peaceful use in manufacturing industries.

If considering using the product in other industries, consult SMC beforehand and exchange specifications or a contract if necessary.

If anything is unclear, contact your nearest sales branch.

## **Limited warranty and Disclaimer/Compliance Requirements**

The product used is subject to the following “Limited warranty and Disclaimer” and “Compliance Requirements”.

Read and accept them before using the product.

### **Limited warranty and Disclaimer**

#### **1. The warranty period of the product is 1 year in service or 1.5 years after the product is delivered, whichever is first.\*2)**

Also, the product may have specified durability, running distance or replacement parts. Please consult your nearest sales branch.

#### **2. For any failure or damage reported within the warranty period which is clearly our responsibility, a replacement product or necessary parts will be provided.**

This limited warranty applies only to our product independently, and not to any other damage incurred due to the failure of the product.

#### **3. Prior to using SMC products, please read and understand the warranty terms and disclaimers noted in the specified catalog for the particular products.**

#### **\*2) Vacuum pads are excluded from this 1 year warranty.**

A vacuum pad is a consumable part, so it is warranted for a year after it is delivered.

Also, even within the warranty period, the wear of a product due to the use of the vacuum pad or failure due to the deterioration of rubber material are not covered by the limited warranty.

### **Compliance Requirements**

#### **1. The use of SMC products with production equipment for the manufacture of weapons of mass destruction (WMD) or any other weapon is strictly prohibited.**

#### **2. The exports of SMC products or technology from one country to another are governed by the relevant security laws and regulations of the countries involved in the transaction. Prior to the shipment of a SMC product to another country, assure that all local rules governing that export are known and followed.**

# 1. Specifications

## 1-1 Specifications

Fluid	Air
Proof pressure	1.5 MPa
Max. operating pressure	1.0 Mpa
Min. operating pressure	0.05Mpa
Ambient and fluid temperature	-10 to +70 °C. With magnet built in: -10 to +60 °C (No freezing)
Lubrication	Not required (non-lube)
Stroke length tolerance	$+1.4$ $0$ mm
Cushion	Air cushion
Piston speed	50 to 1000 mm/s



### Warning

#### - Confirm the specifications.

The product is designed only for use in industrial compressed air systems. Do not operate at pressures or temperatures, etc., beyond the range of specifications, as this can cause damage or malfunction. (Refer to the specifications.)

Contact SMC in advance for non-industrial uses, or if using with a fluid other than compressed air.



### Warning

#### - A deceleration circuit or shock absorber etc., may be required.

When a driven object moves at high speed or the load is heavy, it will be unfeasible for only the cylinder's cushion to absorb the shock. Therefore provide a speed reduction circuit to reduce the cylinders speed before the thrust is applied to the cushion or install an external shock absorber to dampen the shock. If these countermeasures are taken confirm the rigidity of the equipment carefully.

# 2. Installation and Handling

## 2-1. Air supply

The compressed air supplied to the cylinder should be filtered by SMC AF series air filter and regulated to the specified set pressure by SMC AR series regulator.



### Warning

#### - Use clean air.

Do not use compressed air that contains chemicals, synthetic oils including organic solvents, salts or corrosive gases, etc., as this can cause damage or malfunction.

## **Caution**

### **1) Install an air filter.**

Install an air filter upstream near the valve. Select an air filter with a filtration size of 5µm or smaller.

### **2) Take measure to ensure air quality, such as by installing an after cooler, air dryer or water separator.**

Compressed air that contains a large amount of drainage can cause malfunction of pneumatic equipment such as valves. Therefore, take appropriate measures to ensure air quality, such as providing an after cooler, air dryer, or water separator.

### **3) Use the product within the specified fluid and ambient temperature range.**

When operating at temperatures below 5°C, water in the circuit may freeze and cause breakage of seals or malfunction. Corrective measures should be taken to prevent freezing.

For compressed air quality, refer to Best Pneumatics No.5.

### **4) Lubrication of non-lubricating cylinder**

Install a lubricator in the circuit, and use Class 1 turbine oil (with no additive) ISO VG32. Stopping lubrication later may lead to malfunction because the new lubricant will displace the original lubricant. Therefore, lubrication must be continued once it has been started.

## **2-2. Design**

## **Warning**

### **1) There is a possibility of dangerous sudden action by cylinders if sliding parts of machinery are twisted due to external forces, etc.**

In such cases, human injury may occur; e.g., by catching hands or feet in the machinery, or damage to the machinery itself may occur. Therefore, the machine should be designed to operate smoothly and avoid such dangers.

### **2) If there is a chance that the product will pose a hazard to humans, install a protective cover.**

If the moving portion of the product will pose a hazard to humans or will damage machinery or equipment, provide a construction that prevents direct contact with those areas.

### **3) Be certain that the secured portions will not loosen.**

When the product operates with high frequency or is installed where there is a lot of vibration, ensure that all parts remain secure.

### **4) Design the system so that it will not apply any external force over the maximum force to the product.**

The product can break, causing a risk of injury or damage to equipment.

**5) The cylinder generates a large force. Install on a sufficiently rigid mounting base, taking this force into consideration.**

There is a risk of human injury or damage to equipment.

**6) Do not turn the cover**

If cover is rotated during installation or screwing fitting assembly into port, it's possible that cylinder tube connection can be damaged.

**7) Consider the possibility of a reduction in the circuit air pressure that could be caused by a power failure.**

There is a danger of work piece dropping if there is a decrease of thrust due to a drop in circuit pressure caused by a power outage, etc. Therefore, safety equipment should be installed to prevent damage to machinery and/or human injury. Suspension equipment and lifting devices also require measures to prevent dropping.

**8) Consider the possibility of power source related malfunctions.**

For equipment that relies on power sources such as compressed air, electricity, or hydraulic pressure, adopt countermeasures to prevent the equipment from causing a hazard to humans or damage to the equipment in the event of malfunction.

**9) Consider emergency stop.**

Devise a safety system so that if a person engages the emergency stop, or if a safety device is tripped during a system malfunction such as a power outage, the movement of the cylinder will not cause a hazard to humans or damage the equipment.

**10) Consider the action when operation is restarted after an emergency stop or abnormal stop.**

Design the machinery so that injury or equipment damage will not occur upon restart of operation. Install manually controlled equipment for safety when the actuator has to be reset to the starting position.

**11) Intermediate stop**

It is difficult for this product to make a piston stop at the required intermediate position accurately and precisely by a 3 position closed center type directional control valve, due to the compressibility of air. Furthermore, since valves and cylinders are not guaranteed for zero air leakage, it may not be possible to hold a stopped position for extended periods of time. Contact SMC if it is necessary to hold the stopped position for extended periods of time.



**Caution**

**1) Operate the product within a range such that the piston will not collide and be damaged at the stroke end.**

If the piston with inertia force is expected to stop by colliding with the cover at the stroke end, use it within a range that will not cause damage. (Refer to P11 for Allowable kinetic energy)

- 2) Avoid having a large gap between the clevis or trunnion and mating bushing, as this exposes the pin to a bending load.**
- 3) Do not let foreign matter such as cutting chips get into the product from the suction port.**
- 4) Do not touch the cylinder during high speed and high frequency operation.**

When the cylinder is operating at a high speed and high frequency, the cylinder tube surface temperature increases, and may cause a burn.

- 5) Do not use the air cylinder as an air-hydro cylinder.**

If working fluid of the air cylinder is turbine oil, oil leakage can result.

- 6) Grease is applied to cylinder.**

- 7) The base oil of grease may seep out.**

The base oil of grease in the cylinder may seep out of the tube, cover, crimped part or rod bushing depending on the operating conditions (ambient temperature 40 °C or more, pressurized condition, low frequency operation).



## 2-3. Mounting and Installation

- 1) There is a tolerance location diameter at the base of the cover mounting threads specifically for accurate alignment when mounting.
- 2) The foot mounting cylinder has a hole in the foot to drive a pin into for accurate positioning and fixing.

### Caution

- 1) **Do not apply excessive lateral load to the piston rod.**

The bold solid lines in Fig. 1 show the allowable lateral load on the cylinder for a certain stroke length.

(Refer to Page 11, 2-6. Air cushion.)

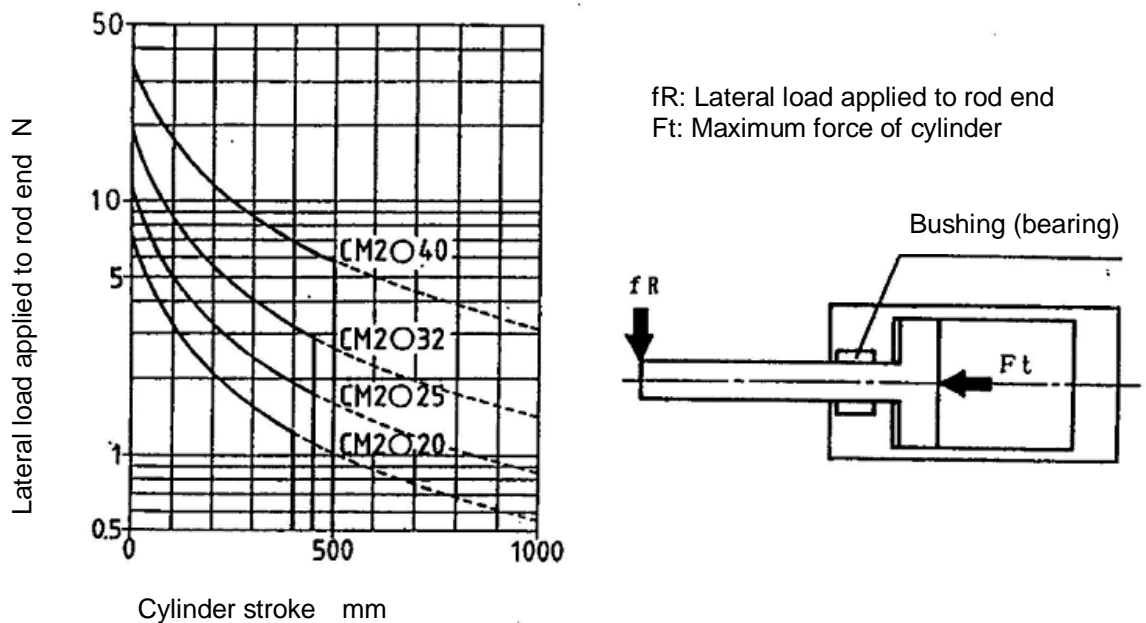

**Fig. 1 Allowable lateral load applied to rod end**

Calculation for excessive lateral load:

Minimum operating pressure value after the device is mounted (MPa) = Cylinder's minimum operating pressure(MPa) + {Load weight(kg) × Guide friction coefficient / Cylinder's cross section (mm<sup>2</sup>)}

If the product is found to operate smoothly with the calculated pressure, it can be judged that the alignment of the guides have not created additional loading on the cylinder.

- 2) **Make sure to connect the piston rod and the load so that their axial centers and movement directions match.**

If they do not match, stress could be applied to the rod and the cylinder tube, causing the inner surface of the cylinder tube, the bushing, the rod surface, and the seals to wear and become damaged.

**3) When an external guide is used, connect the piston rod end and the load in such a way that there is no interference at any point within the stroke.**

**4) Do not apply any torque to the cover jointed part.**

The rod cover and head cover have wrench flats with sufficient width. Apply an appropriate tightening force during mounting. Avoid working in a way such that one cover is fixed and torque is applied to the other cover.

**5) When female rod end is used, use a washer, etc. to prevent the contact part at the rod end from being deformed depending on the material of the work piece.**

**6) Do not hit or grasp the sliding parts of the cylinder tube and piston rod with other objects.**

Cylinder bores are manufactured to precise tolerances, so that even a slight deformation may cause malfunction.

Moreover, scratches or dents, etc. in the piston rod may lead to damaged seals and cause air leakage.

**7) Prevent the seizure of rotating parts.**

Prevent the seizure of rotating parts (pins, etc.) by applying grease.

**8) Do not use the product until you have verified that the equipment can operate properly.**

Verify correct mounting by function and leak tests properly after compressed air and power are connected following mounting or repair.

**9) Do not let foreign matter such as cutting chips get into the product from the suction port.**

When the product is installed on a machine on site, the debris from drilled mounting holes can get in the supply port of the product. Take sufficient care to prevent this.



### **Caution**

**When rod end female thread is used, use a thin spanner wrench when tightening the piston rod.**

## **2-4. Environment**



### **Warning**

**1) Do not use in environments where there is a danger of corrosion.**

**2) Install a cover over the rod if it is used in an area that is dusty, or in an environment in which water or oil splashes on the cylinder.**

Contact SMC if the operating location contains a lot of dust.

### 3) Avoid storing the product in humid conditions.

Store the product with the piston rod retracted and avoid humidity, in order to prevent generation of rust.



#### Caution

##### 1) Preparation before piping

Before piping is connected, it should be thoroughly blown out with air (flushing) or washed to remove chips, cutting oil and other debris from inside the pipe.

##### 2) Wrapping of sealant tape

When screwing piping or fittings into ports, ensure that chips from the pipe threads or sealing material do not enter the piping.

If a sealant tape is used, leave 1.5 to 2 threads exposed at the end of threads

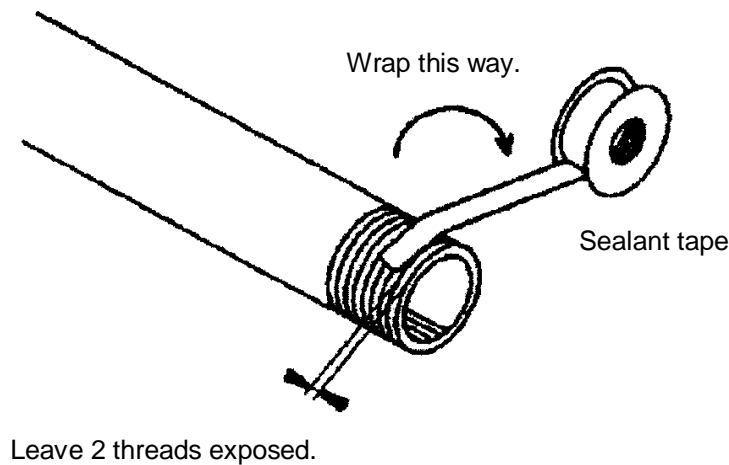

**Fig. 2 Sealant tape**

### 2-5. Speed control

When the piston speed is adjusted, install SMC AS series speed controller near the air supply port to adjust to the specified speed. There are two methods of speed adjustment, one is to restrict air supplied to the product, and the other is to restrict air exhausted from the product. Normally, the latter method should be adopted.



#### Caution

**Use a speed controller to adjust the cylinder drive speed, gradually increasing from a low speed to the desired speed setting.**

## 2-6. Air Cushion

The applied kinetic energy must be within the allowable value when an inertial load is actuated.

Please refer to "Fig.1 Allowable lateral load applied to rod end" (Page 8)

The range surrounded with the bold solid line in Fig. 3 shows the relationship between the allowable load weight and maximum piston speed.

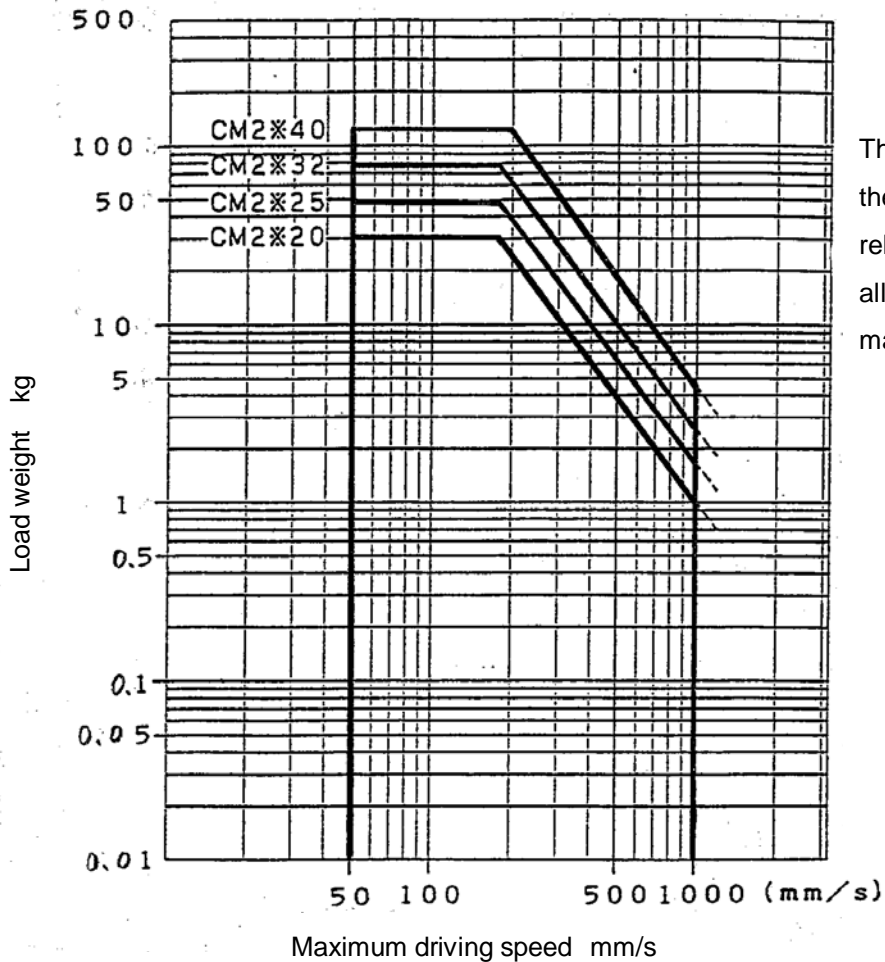

The range surrounded with the bold solid line shows the relationship between the allowable load weight and maximum piston speed.

**Fig. 3. Operating range**

Table 1 Allowable kinetic energy

[J]

Bore size	φ20	φ25	φ32	φ40
Rod end male thread	0.54	0.78	1.27	2.35
Rod end female thread	0.11	0.18	0.29	0.52

The allowable kinetic energy is different between the cylinders with male rod end and with female rod end due to the different thread sizes.

## **Warning**

### **Use the actuator with allowable kinetic energy (Table 1) or less.**

Operation with a kinetic energy over the allowable value can break the product and cause injury or damage to equipment. If excessive kinetic energy is expected, install an external absorber to prevent impact to the body of the product. In this case, please verify the rigidity of the equipment carefully.

## **Caution**

### **1) Readjust with the cushion needle.**

The cushion needle is adjusted when the product is shipped, but the cushion needle on the cover should be readjusted when the product is put into service, based upon factors such as the size of the load and the operating speed. When the cushion needle is turned clockwise, the restriction becomes smaller and the cushion's effectiveness is increased.

The Cushion needle must be adjusted as stated otherwise the cushion seal may become worn and the cushioning effect may be decreased due to the operation of the cylinder over a long period of time.

### **2) Do not operate the cushion valve in the fully closed or fully open state.**

This may damage the seal.

### **3) Do not open the cushion needle too much.**

Do not open the cushion needle completely (3 turns or more from fully closed position), or the cushioning effect will be reduced and the impact may be higher than the cylinders allowable kinetic energy.

## **2-7. Control of direction**

To switch the operating direction of the cylinder, mount an applicable solenoid valve selected from SMC's range of solenoid valves.

## **Warning**

### **1) Design a circuit to prevent sudden action of a driven object.**

When the product is actuated by an exhaust center type directional control valve or when one side of the piston is pressurized with air exhaust, such as when the product is started after the exhaust of the residual pressure from the circuit, driven objects may act suddenly at high speed. In such cases, injury may occur, such as hands or feet getting caught in the machinery, or damage to the machinery itself may occur. Design the machinery using equipment to prevent sudden action.

### **2) Intermediate stop**

It is difficult for this product to make a piston stop at the required intermediate position accurately and precisely by a 3 position closed center type directional control valve, due to the compressibility of air.

Furthermore, since valves and cylinders are not guaranteed for zero air leakage, it may not be possible to hold a stopped position for extended periods of time. Contact SMC if it is necessary to hold the stopped position for extended periods of time.

## 2-8. Auto switches

When an auto switch is mounted or its set position is changed, refer to pages 13 to 18.

### Caution

- Use a specific mounting bracket (Table 2) and mount the product so that the band of the bracket will be perpendicular to the stroke of the product.
- Tighten mounting screws to the appropriate torque.
- The auto switch can only be used for cylinders with a built-in magnet for auto switch (e.g. CDM2).
- The mounting of the switch is limited depending on stroke. (Refer to Page16, Table 3)

**Table 2 Part number of auto switch mounting bracket**

Auto switch model	Bore size (mm)			
	20	25	32	40
D-M9□(V) D-M9□W(V) D-A9□(V)	Note 1) BM5-020	Note 1) BM5-025	Note 1) BM5-032	Note 1) BM5-040
D-M9□A(V)	Note 2) BM5-020S	Note 2) BM5-025S	Note 2) BM5-032S	Note 2) BM5-040S
D-C7□/C80 D-C73C/C80C D-H7□ D-H7□W D-H7NF D-H7BA	BM2-020A	BM2-025A	BM2-032A	BM2-040A
D-B5□/B64 D-B59W D-G5□/K59 D-G5□W/K59W D-G5BA/G59F D-G5NT D-G5NB	BA2-020	BA2-025	BA2-032	BA2-040
D-A3□A/A44A D-G39A/K39A	BM3-020	BM3-025	BM3-032	BM3-040

Note 1) Set part number which includes the auto switch mounting band (BM2-□□□A) and the holder kit (BJ5-1/Switch bracket: Transparent).

Since the switch bracket (made from nylon) are affected in an environment where alcohol, chloroform, methylamines, hydrochloric acid or sulfuric acid is splashed over, so it cannot be used. Please consult SMC regarding other chemicals.

Note 2) Set part number which includes the auto switch mounting band (BM2-□□□AS/Stainless steel screw) and the holder kit (BJ4-1/Switch bracket: White).

Avoid the indicator LED for mounting the switch bracket. As the indicator LED is projected from the switch unit, indicator LED may be damaged if the switch bracket is fixed on the indicator LED.

#### [Stainless Steel Mounting Screw]

The following stainless steel mounting screw kit is available. Use it in accordance with the operating environment. (Since the auto switch mounting bracket is not included, order it separately.)

BBA4: For D-C7/C8/H7 types

Note 3) Refer to page 1358 in Best Pneumatics No. 2 for details on the BBA4.

The above stainless steel screws are used when a cylinder is shipped with the D-H7BA auto switch. When only an auto switch is shipped independently, the BBA4 is attached.

< Applicable Auto switches >

Solid state auto switch---D-M9N·M9P·M9B·M9NV·M9PV·M9BV  
 D-M9NW·M9PW·M9BW·M9NWV·M9PWV·M9BWV  
 D-M9NA·M9PA·M9BA·M9NAV·M9PAV·M9BAV  
 Reed auto switch-----D-A90·A93·A96·A90V·A93V·A96V



Caution

- (1) Ensure that the tightening torque is within the specified range.
- (2) Make sure that auto switch mounting band is not slanted.

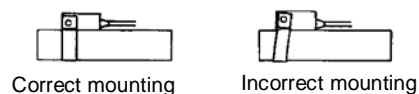
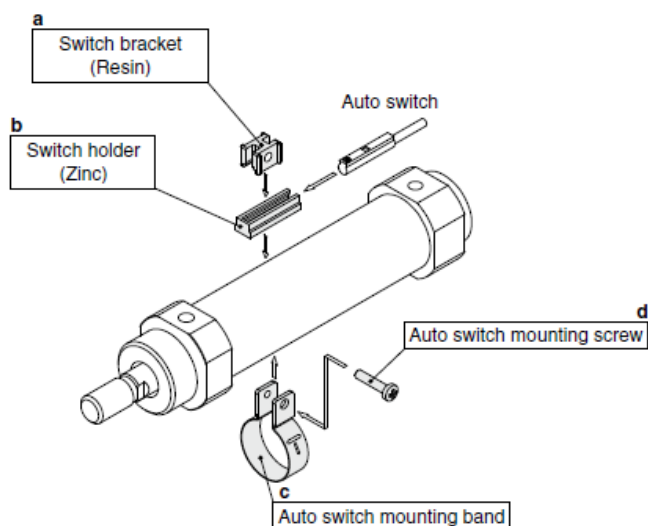
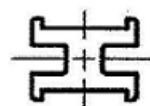

Fig. 4 Mounting and movement of the auto switch



< Switch bracket >



Rib

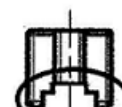

The surface with dent face downward

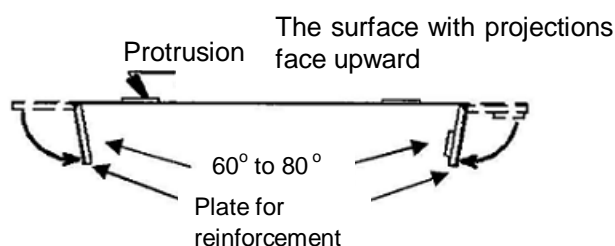

Mounting method of auto switch

- (1) Set the mounting band for the auto switch roughly at the auto switch set position of the cylinder tube.
- (2) Place the switch holder at the opening of (1).
- (3) Face the switch bracket surface with a dent downward to place it on (2).  
 Set the auto switch mounting band so that the both ends of the band are positioned between the switch bracket ribs.  
 For D-M9□A(V), avoid mounting the switch bracket near the indicator LED. As the indicator LED protrudes from the switch unit, mounting the switch bracket above the LED may cause damage to it.
- (4) Insert the auto switch mounting screw (M3) included in accessories from the mounting hole of the auto switch mounting band, inserting the through hole of the switch bracket. Then, screw the mounting screw to M3 female screw of the auto switch mounting band.
- (5) Tighten the auto switch mounting screw with specified tightening torque (0.6 to 0.7 N·m).
- (6) Insert the auto switch to the auto switch mounting groove of the switch holder (2).
- (7) After checking the detecting position, tighten the mounting screw (M2.5) to fix the auto switch.  
 Tightening torque is 0.05 to 0.1Nm.  
 For the tightening of the mounting screws of auto switch, use a watchmaker's screwdriver with a handle diameter of about 5 to 6 mm.

Auto switch position adjusting method

- 1) For fine adjustment, loosen the mounting screw (M2.5) and slide the switch within the mounting groove of the auto switch holder.
- 2) Otherwise, loosen the mounting screw (M3) of the auto switch mounting band, and slide the switch holder on the cylinder tube.

< Cautions for BM5 >

When removing the auto switch mounting screw after assembling the auto switch mounting band, attention should be taken so that the switch bracket, auto switch mounting screw and auto switch mounting band do not come off.

## Auto Switch Proper Mounting Position (Detection at stroke end) and Its Mounting Height

### Solid state auto switch

D-M9□  
D-M9□W  
D-M9□A

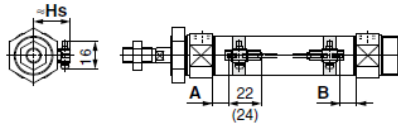

( ): Dimension of the D-M9□A.  
A and B are the dimensions from the end of the head cover/rod cover to the end of the auto switch.

D-M9□V  
D-M9□WV  
D-M9□AV

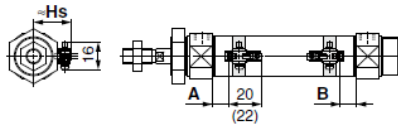

( ): Dimension of the D-M9□AV.  
A and B are the dimensions from the end of the head cover/rod cover to the end of the auto switch.

D-H7□/H7□W/H7NF/H7BA/H7C

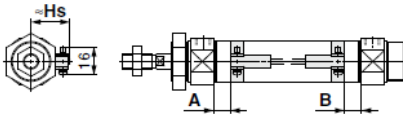

D-G5NT

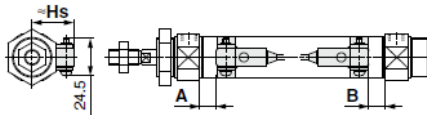

D-G39A/K39A

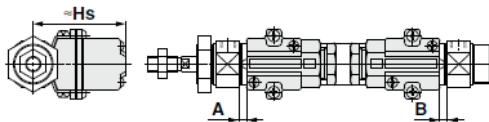

### Reed auto switch

D-A9□

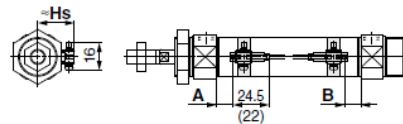

( ): Dimension of the D-A96.  
A and B are the dimensions from the end of the head cover/rod cover to the end of the auto switch.

D-A9□V

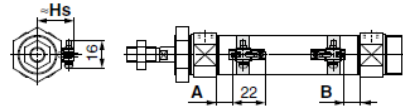

A and B are the dimensions from the end of the head cover/rod cover to the end of the auto switch.

D-C7/C8/C73C/C80C

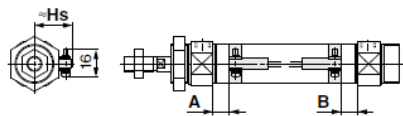

D-B5/B6/B59W

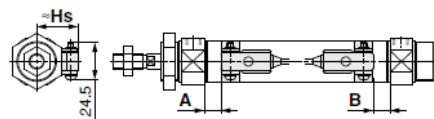

D-A33A/A34A

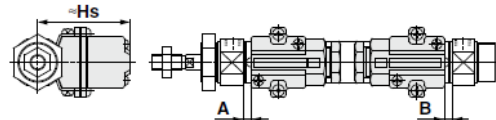

D-A44A

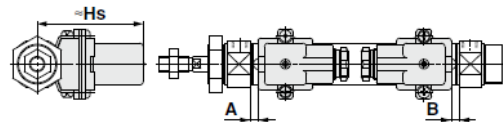



## Auto Switch Proper Mounting Position (Detection at stroke end) and Its Mounting Height

### Auto Switch Proper Mounting Position

(mm)

Auto switch model	D-M9□(V) D-M9□W(V) D-M9□A(V)		D-A9□(V)		D-C7/C8 D-C73C D-C80C		D-B5 D-B6		D-B59W		D-G39A D-K39A D-A3□A D-A44A		D-H7□ D-H7C D-H7□W D-H7BA D-H7NF		D-G5NT	
	A	B	A	B	A	B	A	B	A	B	A	B	A	B	A	B
20	11	9.5	7	5.5	7.5	6	1.5	0	4	2.5	1	0	6.5	5	3	1.5
25	10	10	6	6	6.5	6.5	0.5	0.5	3.5	3.5	0	0	5.5	5.5	2	2
32	11.5	10.5	7.5	6.5	8	7	2	1	5	4	1.5	0.5	7	6	3.5	2.5
40	17.5	15.5	13.5	11.5	14	12	8	6	11	9	7.5	5.5	13	11	9.5	7.5

Note) Adjust the auto switch after confirming the operating condition in the actual setting.

### Auto Switch Mounting Height

(mm)

Auto switch model	D-M9□V D-M9□WV D-M9□AV D-A9□V		D-M9□ D-M9□W D-M9□A D-A9□ D-H7□ D-H7□W D-H7NF D-H7BA D-C7/C8		D-G5NT D-H7C D-B5□ D-B64 D-B59W		D-C73C D-C80C		D-G39A D-K39A D-A3□A		D-A44A	
	Hs		Hs		Hs		Hs		Hs		Hs	
20	23.5		22.5		25.5		25		60		69.5	
25	26		25		28		27.5		62.5		72	
32	29.5		28.5		31.5		31		66		75.5	
40	33.5		32.5		35.5		35		70		79.5	

Table 3 Minimum Stroke for Auto Switch Mounting

n: Number of auto switches (mm)

Auto switch model	Number of auto switches				
	With 1 pc.	With 2 pcs.		With n pcs.	
		Different surfaces	Same surface	Different surfaces	Same surface
D-M9□	5	20	55	$20 + 35 \frac{(n-2)}{2}$ (n = 2, 4, 6...)	$55 + 35 (n-2)$ (n = 2, 3, 4, 5...)
D-M9□W	10	20	55	$20 + 35 \frac{(n-2)}{2}$ (n = 2, 4, 6...)	$55 + 35 (n-2)$ (n = 2, 3, 4, 5...)
D-M9□A	10	25	60	$25 + 35 \frac{(n-2)}{2}$ (n = 2, 4, 6...)	$60 + 35 (n-2)$ (n = 2, 3, 4, 5...)
D-A9□	5	15	50	$15 + 35 \frac{(n-2)}{2}$ (n = 2, 4, 6...)	$50 + 35 (n-2)$ (n = 2, 3, 4, 5...)
D-M9□V	5	20	35	$20 + 35 \frac{(n-2)}{2}$ (n = 2, 4, 6...)	$35 + 35 (n-2)$ (n = 2, 3, 4, 5...)
D-A9□V	5	15	25	$15 + 35 \frac{(n-2)}{2}$ (n = 2, 4, 6...)	$25 + 35 (n-2)$ (n = 2, 3, 4, 5...)
D-M9□WV D-M9□AV	10	20	35	$20 + 35 \frac{(n-2)}{2}$ (n = 2, 4, 6...)	$35 + 35 (n-2)$ (n = 2, 3, 4, 5...)
D-C7□ D-C80	5	20	60	$20 + 45 \frac{(n-2)}{2}$ (n = 2, 4, 6...)	$60 + 45 (n-2)$ (n = 2, 3, 4, 5...)
D-H7□ D-H7□W D-H7BA D-H7NF	10	25	70	$25 + 45 \frac{(n-2)}{2}$ (n = 2, 4, 6...)	$70 + 45 (n-2)$ (n = 2, 3, 4, 5...)
D-C73C D-C80C D-H7C	15	30	80	$30 + 50 \frac{(n-2)}{2}$ (n = 2, 4, 6...)	$80 + 50 (n-2)$ (n = 2, 3, 4, 5...)
D-B5□ D-B64 D-G5□ D-K59□	10	25	70	$25 + 50 \frac{(n-2)}{2}$ (n = 2, 4, 6...)	$70 + 50 (n-2)$ (n = 2, 3, 4, 5...)
D-B59W	15	30	75	$30 + 50 \frac{(n-2)}{2}$ (n = 2, 4, 6...)	$75 + 50 (n-2)$ (n = 2, 3, 4, 5...)
D-A3□A D-G39A D-K39A D-A44A	20	35	110	$35 - 30 (n-2)$ (n = 2, 3, 4, 5...)	$110 + 100 (n-2)$ (n = 2, 3, 4, 5...)

Note 1) Auto switch mounting

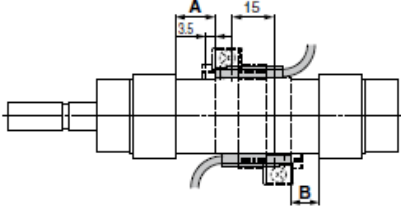
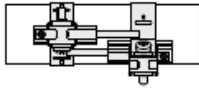
Auto switch model	With 2 auto switches	
	Different surfaces	Same surface
	 <p>The auto switch proper mounting position is 3.5 mm inward from the switch holder edge.</p>	 <p>The auto switch is mounted by slightly displacing it in a direction (cylinder tube circumferential exterior) so that the auto switch and lead wire do not interfere with each other.</p>
D-M9□ D-M9□W	Less than 20 stroke <i>Note 2)</i>	Less than 55 stroke <i>Note 2)</i>
D-M9□A	Less than 25 stroke <i>Note 2)</i>	Less than 60 stroke <i>Note 2)</i>
D-A9□	—	Less than 50 stroke <i>Note 2)</i>

Note 2) Minimum stroke for auto switch mounting in styles other than those mentioned in Note 1.

## Operating Range

Auto switch model	Bore size (mm)			
	20	25	32	40
D-M9□(V) D-M9□W(V) D-M9□A(V)	3	3	4	3.5
D-A9□	6	6	6	6
D-C7□/C80 D-C73C/C80C	7	8	8	8
D-B5□/B64 D-A3□A/A44A	8	8	9	9
D-B59W	12	12	13	13
D-H7□/H7□W/H7BA D-G5NT/H7NF	4	4	4.5	5
D-H7C	7	8.5	9	10
D-G39A/K39A	8	9	9	9

\* Values which include hysteresis are for guideline purposes only, they are not a guarantee (assuming approximately  $\pm 30\%$  dispersion) and may change substantially depending on the ambient environment.

Other than the applicable auto switches listed in "How to Order," the following auto switches are mountable. Refer to pages 1263 to 1371 in Best Pneumatics No. 2 for detailed specifications.

Type	Model	Electrical entry (Entry direction)	Features
Solid state	D-H7A1/H7A2/H7B	Grommet (In-line)	—
	D-H7NW/H7PW/H7BW		Diagnosis indication (2-color indication)
	D-H7BA		Water resistant (2-color indication)
	D-G5NT		With timer
Reed	D-B53/C73/C76		—
	D-C80	Without indicator light	

\* With pre-wired connector is also available for solid state auto switches. For details, refer to pages 1328 and 1329 in Best Pneumatics No. 2.

\* Normally closed (NC = b contact) solid state auto switches (D-F9G/F9H) are also available. For details, refer to page 1290 in Best Pneumatics No. 2.

\* Wide range detection type, solid state auto switch (D-G5NBL) is also available. For details, refer to page 1320 in Best Pneumatics No. 2.

# Auto Switch Connection and Example

## Sink Input Specifications

3-wire, NPN

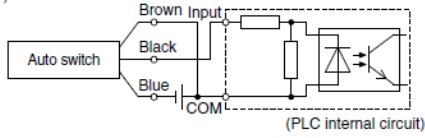

2-wire

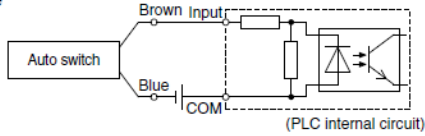

## Source Input Specifications

3-wire, PNP

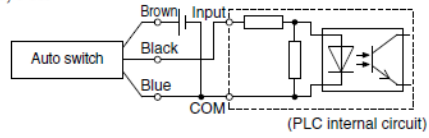

2-wire

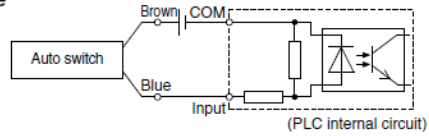

Connect according to the applicable PLC input specifications, as the connection method will vary depending on the PLC input specifications.

## Example of AND (Series) and OR (Parallel) Connection

3-wire, AND connection for NPN output (Using relays)

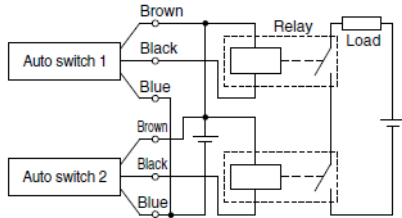

(Performed with auto switches only)

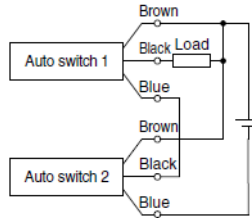

3-wire, OR connection for NPN output

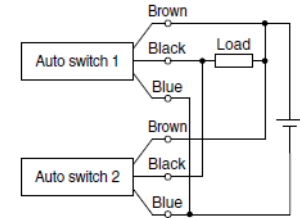

3-wire, AND connection for PNP output (Using relays)

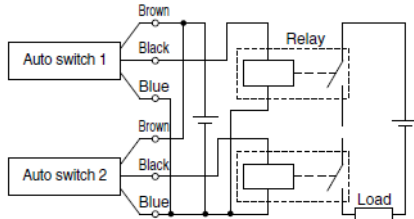

(Performed with auto switches only)

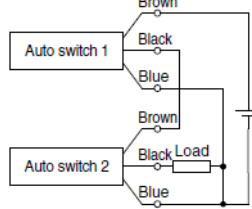

3-wire, OR connection for PNP output

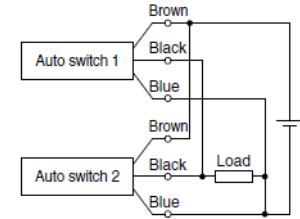

2-wire, AND connection

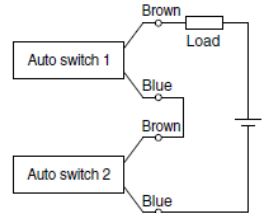

When two auto switches are connected in series, malfunction may occur because the load voltage will decrease in the ON state. The indicator lights will light up when both of the auto switches are in the ON state.

2-wire, OR connection

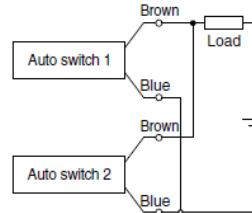

(Solid state)  
When two auto switches are connected in parallel, malfunction may occur because the load voltage will increase in the OFF state.

(Reed)  
Because there is no leakage current, the load voltage will not increase in the OFF state. However, depending on the number of auto switches in the ON state, the indicator lights may sometimes grow dim or not light up, due to the dispersion and reduction of the current flowing to the auto switches.

$$\begin{aligned} \text{Load voltage at ON} &= \text{Power supply voltage} - \text{Residual voltage} \times 2 \text{ pcs.} \\ &= 24 \text{ V} - 4 \text{ V} \times 2 \text{ pcs.} \\ &= 16 \text{ V} \end{aligned}$$

Example: Power supply voltage 24 VDC  
Auto switch internal voltage drop 4 V

$$\begin{aligned} \text{Load voltage at OFF} &= \text{Leakage current} \times 2 \text{ pcs.} \times \text{Load impedance} \\ &= 1 \text{ mA} \times 2 \text{ pcs.} \times 3 \text{ k}\Omega \\ &= 6 \text{ V} \end{aligned}$$

Example: Load impedance 3 kΩ  
Auto switch leakage current 1 mA

### 3. Maintenance

#### Caution

In the CM2-\*AZ series, the cover and cylinder tube are joined by rolling crimping, and cannot be disassembled.

#### 3-1 Replacement of rod seal

Rod seal can be replaced while the cylinder is mounted. Replace by the following procedure.

##### a) Removal

Remove retaining ring 1 using a specific tool (retaining ring pliers) and plug the port of the rod cover with your finger. When the piston rod is removed, the seal holder 2 and rod seal 3 will come apart.

##### b) Application of grease

Use our recommended grease.

Grease pack part number: GR-S-010 (10g), GR-S-020 (20g)

Apply plenty of grease to the internal and external circumference of a new rod seal for replacement (See Table 4, P20). Fill the groove with grease.

Refer to Page 22 for made to order product (XC85, X446).

##### c) Mounting

Mount taking care that the rod seal is in the right direction. When passing the rod seal through the threaded part at the piston rod end and wrench flats, push it slowly while turning it slightly, and fit it firmly to the housing of the rod cover.

Then, mount the seal holder 2 and retaining ring 1.

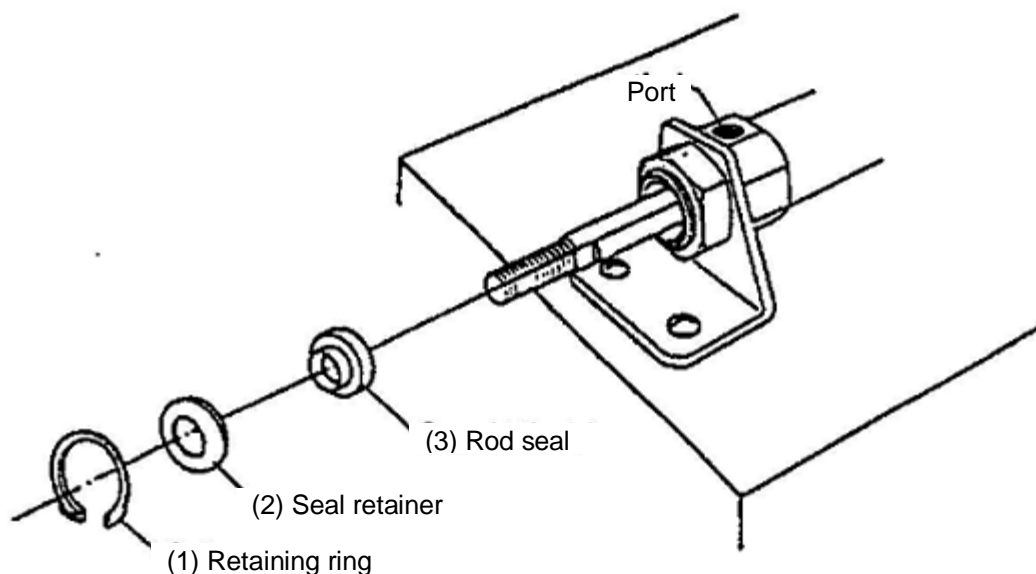

**Fig. 5 Replacement of rod seal**

## 3-2. Checks

### 3-2-1 Daily check

- 1) Smoothness of the operation
- 2) Changes in piston speed and cycle time
- 3) Proper stroking

### 3-2-2 Regular check

- 1) Looseness of mounting nuts and rod end nuts
- 2) Looseness of mounting frame and excessive deflection
- 3) Smoothness of the operation
- 4) Changes in piston speed and cycle time
- 5) External leakage
- 6) Proper stroking
- 7) Damage to the piston rod
- 8) Whether drainage in the air filter is regularly discharged or not.

Check the points above at least, and retighten or contact the sales representative if any failure is found.



### Warning

#### 1) Maintenance should be performed according to the items above.

Improper handling can cause damage and malfunction of equipment and machinery.

#### 2) Removal of equipment, and supply/exhaust of compressed air

When equipment is serviced, first confirm that measures are in place to prevent dropping of driven objects and run-away of equipment, etc. Then cut the supply pressure and power, and exhaust all compressed air from the system using its residual pressure release function.

When machinery is restarted, check that operation is normal with actuators in the proper positions.

## 3-3. Consumable parts

### 3-3-1 Replacement parts

The replacement parts can be ordered as shown below.

Table 4

	φ20	φ25	φ32	φ40
Rod seal	CM20Z-PS	CM25Z-PS	CM32Z-PS	CM40Z-PS

The rod seal is not delivered in sealed packaging for storage independently, so it must be used within 1 year.

When storage for a longer period is expected, enclose it by packaging (by putting into a polyethylene bag and containing in a box), and store in the following manner.

### **3-3-2 Storage of rod seal**

- 1) Enclose the rod seal in sealed packaging and store.
- 2) Avoid locations exposed to direct sunlight and high temperature and humidity.  
In particular, isolate from equipment that can generate heat, radiation and ozone.
- 3) Do not stack a lot of rod seals, or deform or damage it by putting a heavy object on the top of it.
- 4) White particles can emerge from the surface of the rod seal during storage, but they do not affect its performance.

## 4. Made to order product (XC85, X446)

Made to order product below uses special grease.

(If mixed with other grease, optimum performance cannot be achieved.)

### 4-1. Food Machinery Grease Specification

Standard models -XC85

Grease pack part number: GR-H-010(10g)

Nonfood compound incidental contact.

### Operating Environment



#### Caution

#### Environment for installing cylinder

Do not use in food zone.

<Not installable>

Food zone.....An environment where food which will be sold as merchandize, directly touches the cylinder's components.

Splash zone.....An environment where food which will not be sold as merchandize, directly touches the cylinder's components.

<Installable>

Non-food zone.....An environment where there is no contact with food.

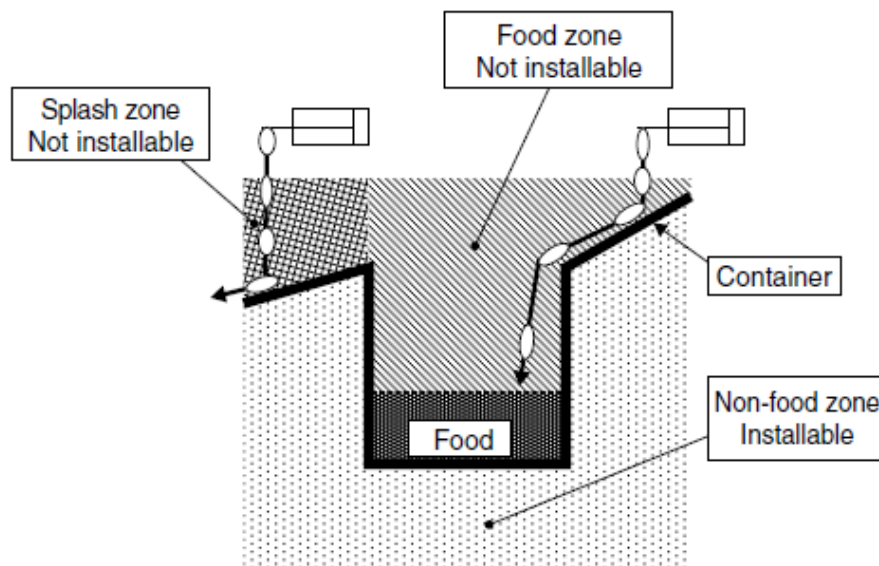

\* When the product is used in an area of liquid splash, or a water resistant function is required for the product, please consult SMC.

### 4-2. PTFE Grease Specification

Standard models -X446

Grease pack part number: GR-F-005(5g)

## Lubrication

### Caution

#### 1) Lubrication for products using special grease

Lubrication to this cylinder leads to operation failure.

Otherwise, it may cause the operating failure.

#### 2) Do not wipe off the grease on the sliding surface of the air cylinder.

If grease applied to the sliding surface is forcibly removed, operation failure can result.

The color of the sliding surface of the cylinder may become black if cylinder travels for long distance.

In this case, the life can be lengthened by wiping off the grease and apply new grease.

(Use water to wipe off the grease. Alcohol or special solvent may damage the seal.)

## 5. Basic Circuit for Cylinder Operation

The basic circuit for operating the product with air filter, regulator, solenoid valve and speed controller (meter-out) is shown in the following figure.

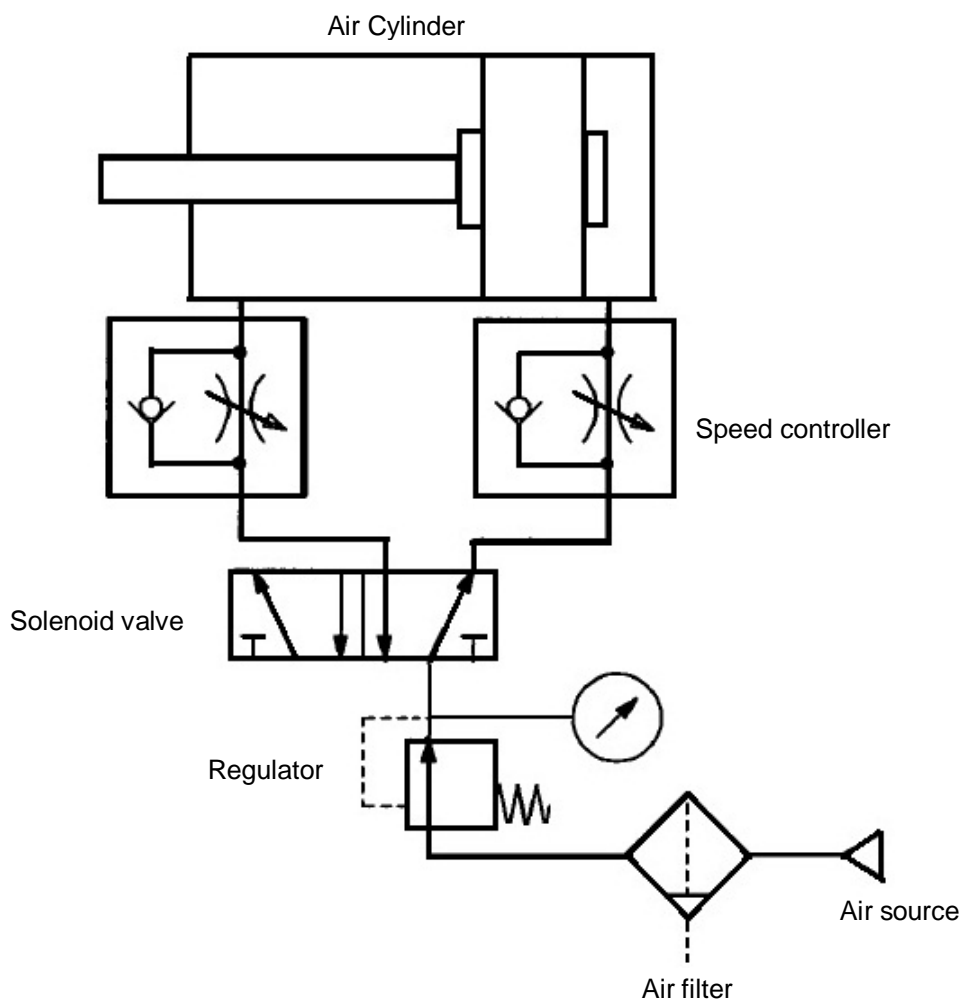

**Fig. 6 Basic Circuit**



## 6. Troubleshooting

Trouble	Major causes	Countermeasures
Operation has lost smoothness.	1. Shortage of grease at the sliding part of the piston rod	- Apply the specified grease. GR-S-010(10g), GR-S-020(20g)
	2. Deformation of piston rod	- Replace the cylinder with a new one. When reinstalling the product, adjust the load and mounting position.
	3. Insufficient pressure	- Supply appropriate pressure.
	4. Operation at a low speed outside of the limit.	- Consult SMC.
Force has decreased.	1. Air leakage from piston seal	- Replace the cylinder with a new one.
	2. Air leakage from rod seal	- Replace the rod seal with a new one.
	3. Decreased pressure	- Secure sufficient pressure and review margin of air supply source.
	4. Insufficient flow rate	- The resistance in the fluid path may have increased due to deformation or foreign matter entering the product. Perform repair or cleaning.
	5. Incorrect mounting position of the product	- Mount in a proper position without any force applied to the product.
	6. Deformation of piston rod	- Replace the cylinder with a new one. When reinstalling the product, adjust the load and mounting position.
	7. Lubrication failure	- Refer to the countermeasure for the trouble "Operation has lost smoothness."
Piston speed is too fast.	1. Lack of speed controller	- Use a speed controller suitable for the size of the product.
	2. Insufficient fine adjustment of the speed controller	- Select an adjustable speed controller to obtain the required piston speed referring to the flow-rate characteristics curve.

Trouble	Major causes	Countermeasures
Piston speed is too slow.	1. Too small directional control valve.	- Use a valve of a larger size.
	2. Too large resistance of equipment used on the way of piping	- Use valves and equipment of an appropriate size - In particular, attention should be paid to the piping and fittings because they are often missed. Equipment and piping at the exhaust side should also be of an appropriate size.
The product sometimes does not operate.	1. Operation at a very low speed	- Operation at a very low speed can create a condition with almost no pressure difference between the supply side and exhaust side and lower sealing effect, which can cause operation failure. Keep the specified speed for operation.
	2. Problem of equipment other than this product	- Check all items in the system one by one to find the cause.
The product has become unable to operate.	1. Damage of piston seal	- Check that the exhaust port of the valve is exhausting all the time. - Replace the cylinder with a new one.
	2. Problem of equipment other than this product	- Check all items in the system one by one to find the cause.
	3. Insufficient pressure	- Supply appropriate pressure.
The piston rod has been deformed and broken.	1. Operation at high speed	- Operation at a high speed can cause impact, and deform and damage the product. Keep within the specified piston speed range.
	2. Excessive external force	- It may cause damage and deformation of the cylinder if the mechanism interferes or eccentric load or over load is applied to it. Remove these factors.
Piston speed cannot be adjusted with the speed controller.	1. Incorrect speed controller selection	- Use a speed controller of a suitable size for the required speed.
	2. Problem of the speed controller.	- Replace the speed controller with a new one.

Trouble	Major causes	Countermeasures
The product has stick and slip movement.	1. Cylinder speed too slow	- Consult SMC.
	2. Insufficient margin of force	- Increase operating pressure. - Replace with a product of a larger bore size.
	3. Use of a meter-in circuit	- Operation at a low pressure or low speed with a meter-in circuit can cause unstable motion. Use a meter-out circuit for speed adjustment.
The product shows sudden and fast movement after being stopped for extended periods of time.	1. Fluctuation of residual pressure in the product between continuous operation and operation after stoppage for extended periods of time	- Consider the use of a valve to prevent sudden action of the product.

## 7. Construction

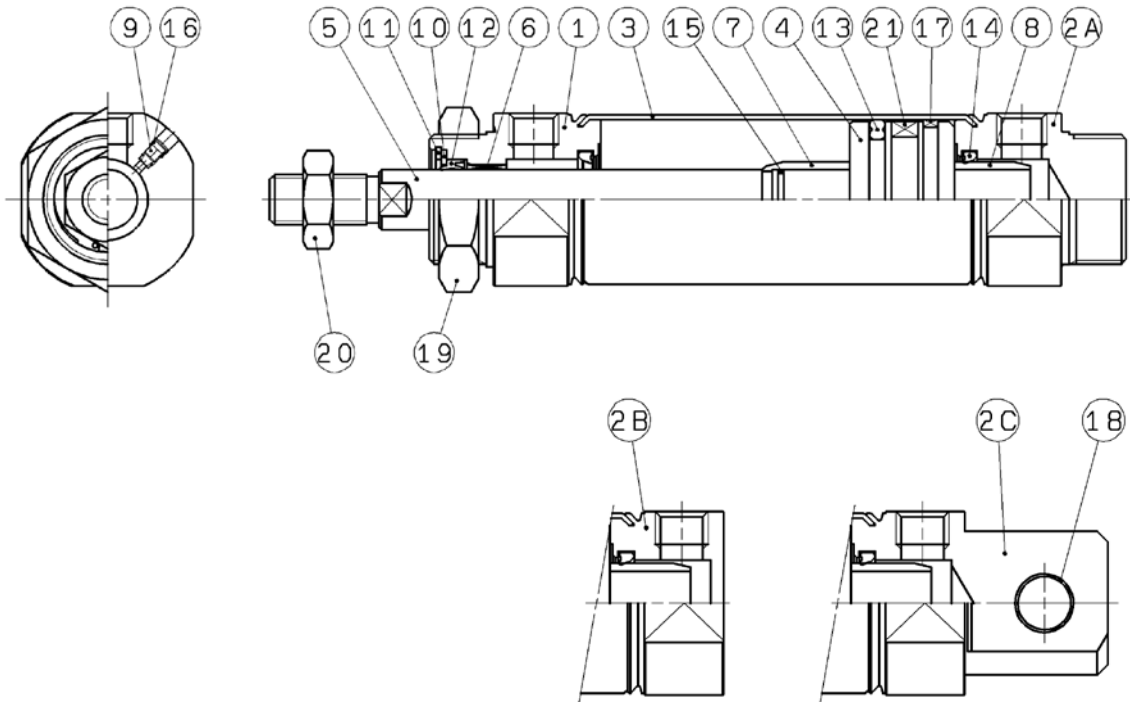

**Fig. 7 Standard product: Double acting / single rod / Air cylinder with air cushion**

No.	Description	Note
1	Rod cover	
2A	Head cover A	For Basic type
2B	Head cover B	For Boss-cut type
2C	Head cover C	For Integral clevis type
3	Cylinder tube	
4	Piston	
5	Piston rod	
6	Bushing	
7	Cushion ring A	
8	Cushion ring B	
9	Cushion needle	
10	Seal retainer	
11	Retaining ring	
12	Rod seal	
13	Piston seal	
14	Cushion seal	
15	Cushion ring gasket	
16	Needle seal	
17	Wear ring	
18	Bushing for clevis	
19	Mounting nut	
20	Rod end nut	
21	Plastic magnet	For CDM2

Revision history
------------------

## SMC Corporation

4-14-1, Sotokanda, Chiyoda-ku, Tokyo 101-0021 JAPAN

Tel: + 81 3 5207 8249 Fax: +81 3 5298 5362

URL <http://www.smcworld.com>