



Operation Manual

PRODUCT NAME

SPEED CONTROLLER WITH ONE-TOUCH FITTING
PUSH-LOCK TYPE / JAS SERIES

MODEL/ Series/ Product Number

JAS-L***-**

SMC Corporation

Contents

1. Safety Instructions	2 ~ 3
2. Specific Product Precautions	4 ~ 8
3. Application	9
4. Specifications	9
5. Malfunctions and Countermeasures	9
6. Construction	10



Speed Controller with One-touch Fitting Push-Lock Type / JAS Series Safety Instructions

These safety instructions are intended to prevent hazardous situations and/or equipment damage. These instructions indicate the level of potential hazard with the labels of "Caution," "Warning" or "Danger." They are all important notes for safety and must be followed in addition to International Standards (ISO/IEC)*1), and other safety regulations.

*1) ISO 4414: Pneumatic fluid power -- General rules relating to systems.

ISO 4413: Hydraulic fluid power -- General rules relating to systems.

IEC 60204-1: Safety of machinery -- Electrical equipment of machines .(Part 1: General requirements)

ISO 10218: Manipulating industrial robots -Safety.

etc.



Caution

Caution indicates a hazard with a low level of risk which, if not avoided, could result in minor or moderate injury.



Warning

Warning indicates a hazard with a medium level of risk which, if not avoided, could result in death or serious injury.



Danger

Danger indicates a hazard with a high level of risk which, if not avoided, will result in death or serious injury.



Warning

1. The compatibility of the product is the responsibility of the person who designs the equipment or decides its specifications.

Since the product specified here is used under various operating conditions, its compatibility with specific equipment must be decided by the person who designs the equipment or decides its specifications based on necessary analysis and test results.

The expected performance and safety assurance of the equipment will be the responsibility of the person who has determined its compatibility with the product.

This person should also continuously review all specifications of the product referring to its latest catalog information, with a view to giving due consideration to any possibility of equipment failure when configuring the equipment.

2. Only personnel with appropriate training should operate machinery and equipment.

The product specified here may become unsafe if handled incorrectly.

The assembly, operation and maintenance of machines or equipment including our products must be performed by an operator who is appropriately trained and experienced.

3. Do not service or attempt to remove product and machinery/equipment until safety is confirmed.

1. The inspection and maintenance of machinery/equipment should only be performed after measures to prevent falling or runaway of the driven objects have been confirmed.

2. When the product is to be removed, confirm that the safety measures as mentioned above are implemented and the power from any appropriate source is cut, and read and understand the specific product precautions of all relevant products carefully.

3. Before machinery/equipment is restarted, take measures to prevent unexpected operation and malfunction.

4. Contact SMC beforehand and take special consideration of safety measures if the product is to be used in any of the following conditions.

1. Conditions and environments outside of the given specifications, or use outdoors or in a place exposed to direct sunlight.

2. Installation on equipment in conjunction with atomic energy, railways, air navigation, space, shipping, vehicles, military, medical treatment, combustion and recreation, or equipment in contact with food and beverages, emergency stop circuits, clutch and brake circuits in press applications, safety equipment or other applications unsuitable for the standard specifications described in the product catalog.

3. An application which could have negative effects on people, property, or animals requiring special safety analysis.

4. Use in an interlock circuit, which requires the provision of double interlock for possible failure by using a mechanical protective function, and periodical checks to confirm proper operation.



Speed Controller with One-touch Fitting Push-Lock Type / JAS Series Safety Instructions

Caution

The product is provided for use in manufacturing industries.

The product herein described is basically provided for peaceful use in manufacturing industries.

If considering using the product in other industries, consult SMC beforehand and exchange specifications or a contract if necessary.

If anything is unclear, contact your nearest sales branch.

Limited warranty and Disclaimer/Compliance Requirements

The product used is subject to the following “Limited warranty and Disclaimer” and “Compliance Requirements”.

Read and accept them before using the product.

Limited warranty and Disclaimer

1. The warranty period of the product is 1 year in service or 1.5 years after the product is delivered, whichever is first.

Also, the product may have specified durability, running distance or replacement parts. Please consult your nearest sales branch.

2. For any failure or damage reported within the warranty period which is clearly our responsibility, a replacement product or necessary parts will be provided.

This limited warranty applies only to our product independently, and not to any other damage incurred due to the failure of the product.

3. Prior to using SMC products, please read and understand the warranty terms and disclaimers noted in the specified catalog for the particular products.

Compliance Requirements

1. The use of SMC products with production equipment for the manufacture of weapons of mass destruction (WMD) or any other weapon is strictly prohibited.

2. The exports of SMC products or technology from one country to another are governed by the relevant security laws and regulation of the countries involved in the transaction. Prior to the shipment of a SMC product to another country, assure that all local rules governing that export are known and followed.

Caution

SMC products are not intended for use as instruments for legal metrology.

Measurement instruments that SMC manufactures or sells have not been qualified by type approval tests relevant to the metrology (measurement) laws of each country.

Therefore, SMC products cannot be used for business or certification ordained by the metrology (measurement) laws of each country.

2. Specific Product Precautions

Design/ Selection

Warning

(1) Confirm the specifications.

Do not operate at pressures, temperatures, etc., beyond the range of specifications, as this can cause damage or malfunction. (Refer to the specifications.)

Please contact SMC when using a fluid other than compressed air.

We do not guarantee against any damage if the product is used outside of the specifications range.

(2) Products mentioned in this catalog are not designed for use as stop valves with zero air leakage.

A certain amount of leakage is allowed in the products specifications.

Tightening the needle forcibly to achieve zero leakage may result in damage of contact face stopper.

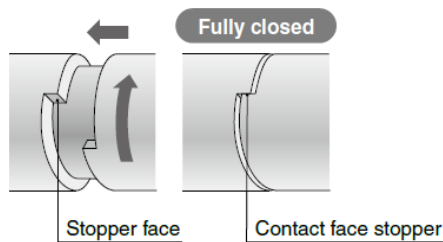

(3) Do not disassemble the product or make any modifications, including additional machining.

Doing so may cause human injury and/or an accident.

(4) The flow rate characteristics for each product are representative values.

The flow rate characteristics are characteristics of each individual product. Actual values may differ depending on the piping, circuitry, pressure conditions, etc.

There will be no flow rate from the fully closed position until 1 turns due to the product characteristic, but this is not the problem.

(5) Sonic conductance and critical pressure ratio values for products are representative values.

For controlled flow direction values the needle is fully open. For free flow direction values the needle fully closed.

Design/ Selection

Warning

(6) Check if PTFE can be used in application.

PTFE powder (Polytetrafluoroethylene resin) is included in the seal material of the male thread type piping taper thread. Confirm that the use of it will not cause any adverse effect on the system. Please contact SMC if the Safety Data Sheet (SDS) is required.

(7) Speed controllers are designed to control the speed of the actuator.

Mounting

Warning

(1) Operation Manual

Install the products and operate it only after reading the operation Manual carefully and understanding its contents. Also, keep the Manual where it can be referred to as necessary.

(2) Ensure sufficient space for maintenance activities.

When installing the products, allow access for maintenance.

(3) Tighten threads with the proper tightening torque.

When installing the products, follow the listed proper torque.

(4) Screw the R screw into the Rc thread, the NPT screw into the NPT thread and the G screw into the G thread.

(5) After pushing the knob down to lock, confirm that it is locked.

When the orange mark is visible, the speed controller is unlocked. Confirm that the knob is locked by pushing the knob in after adjusting the cylinder speed. When the speed controller is unlocked, the set flow may change. If the knob is pulled with force while the speed controller is unlocked, it may result in breakage. When it is unlocked, do not pull the knob out with force.

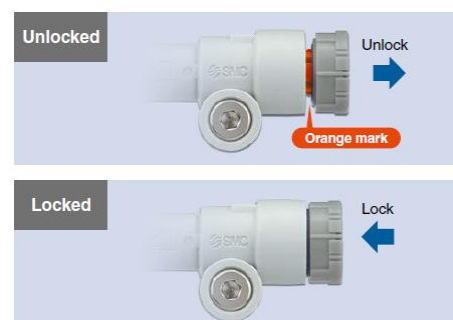

Mounting

Warning

(6) Check the degree of rotation of the needle valve.

The Products in this catalog are retainer type so that the needle is not removed completely. Over rotation will cause damage.

(7) Do not use tools such as pliers to rotate the knob.

It can cause idle rotation of the knob or damage.

(8) Verify the air flow direction.

Mounting backward is dangerous, because the speed adjustment needle will not work and the actuator may lurch suddenly.

(9) Adjust the speed by opening the needle slowly from the fully closed state.

Loose needle valves may cause unexpected sudden actuator extension.

When a needle valve is turned clockwise, it is closed and cylinder speed decreases. When a needle valve is turned counterclockwise, it is open and cylinder speed increases.

Unlock the knob before adjusting the needle valve with a flat blade screwdriver. Excessive torque may break the needle valve.

Refer to the operation applicable torque below.

Connection thread size	Applicable adjusting torque [N·m]	Recommended driver
M3, M5 10-32UNF	0.015	Nominal thickness $a = 0.4$ Nominal width $b = 2.5$ ($t_1 = 0.2$)
1/8	0.03	Nominal thickness $a = 0.5$ Nominal width $b = 3$ ($t_1 = 0.3$)

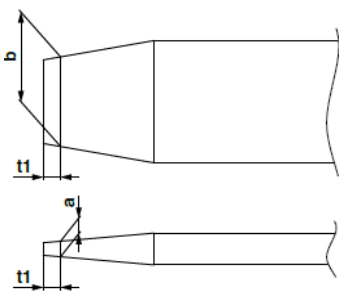

(10) Do not apply excessive force or shock to the body or fittings with an impact tool.

It can cause damage or air leakage.

(11) For handling One-touch fittings, refer to the Fittings and Tubing Precautions.

Mounting

Warning

(12) Insert the hexagon wrench into the end of the hexagonal hole of the stud when removing and mounting the speed controller.

Do not apply torque at other points as the product may be damaged. Rotate Body A manually for positioning after installation. Refer to the applicable dimension of the hexagon wrench.

Connection thread size	Hexagon wrench (Nominal width across flats)	
	Metric size	Inch size
M3, M5	2.5	—
10-32UNF	—	3/32"
R1/8, G1/8	6	—
NPT1/8	—	7/32"

(13) Do not use this product in the operating condition where moment loads will be constantly applied to Body A.

Body A and the fitting section may be damaged.



(14) This product has a stopper for fully close in rotating direction.

Excess torque may break the stopper.

Table below shows the maximum allowable torque of the knob.

Connection thread size	Max. allowable torque [N·m]
M3, M5, 10-32UNF	0.05
01	0.07

Caution

(1) For M3, M5, 10-32UNF

① Tightening method

For M3

First, tighten it by hand, then give it an additional 1/6 turn to 1/4 turn with a hexagon wrench. Refer to Table below for reference.

Connection thread size	Proper tightening torque [N·m]
M3	0.4 to 0.5

Mounting

Caution

For M5,10-32UNF

First, tighten it by hand, then give it an additional 1/6 turn to 1/4 turn with a hexagon wrench. Refer to Table below for reference.

Connection thread size	Proper tightening torque [N·m]
M5, 10-32UNF	1 to 1.5

Note) Excessive tightening may damage the thread portion or deform the gasket and cause air leakage.

If the screw is too shallowly screwed in, it may come loose or air may leak.

② Chamfered area for female thread

In compliance with ISO 16030 (air pressure fluid dynamics – connection – ports and stud ends), the chamfered dimensions shown in the table below are recommended.

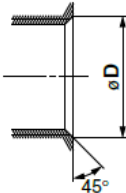

Connection thread size	Chamfer dimension ϕD (Recommended value)
M3	3.1 to 3.4
M5	5.1 to 5.4
10-32UNF	5.0 to 5.3

(2) For R, NPT, G thread

① Tightening method

When tightening the stud, insert an appropriate hexagon wrench to the hexagonal hole after tightening it by hand.

Refer to Table below for reference.

Connection thread size	Proper tightening torque [N·m]
1/8	3 to 5

② Chamfered area of female thread

By chamfering as shown in the table below, machining of threads is easier and effective for burr prevention.

Connection thread size	Chamfer dimension ϕD (Recommended value)		
	Rc	NPT	G Face seal
1/8	10.2 to 10.4	10.5 to 10.7	9.8 to 10.2

*G thread (face seal) complies with ISO16030-2001.

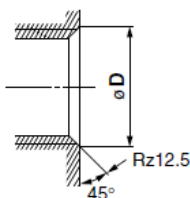

Piping Threads with Sealant

Caution

(1) If the fitting is tightened with excessive torque, a large amount of sealant will seep out. Remove the excess sealant.

(2) Insufficient tightening may loosen the threads, or cause air leakage.

(3) Reuse

① Normally, fittings with a sealant can be reused 2 to 3 times.

② To prevent air leakage through the sealant, remove any loose sealant stuck to the fitting by blowing air over the threaded portion.

③ If the sealant no longer provides effective sealing, wrap sealing tape over the sealant before reusing. Do not use the sealant in any form other than a tape type.

(4) Once the fitting has been tightened, backing it out to its original position often causes the sealant to become defective. Air leakage will occur

(5) Use R external threads with Rc internal threads and NPT external threads with NPT internal threads.

Piping

Caution

(1) Refer to the Fittings & Tubing Precautions for handling One-touch fittings.

(2) Preparation before piping

Before piping is connected, it should be thoroughly blown out with air (flushing) or washed to remove chips, cutting oil and other debris from inside the pipe.

(3) Winding of sealant tape

When screwing together pipes and fittings, etc., be certain that chips from the pipe threads and sealing material do not get inside the pipe.

Also, when the sealant tape is used, leave approx. 1 thread ridges exposed at the end of the threads.

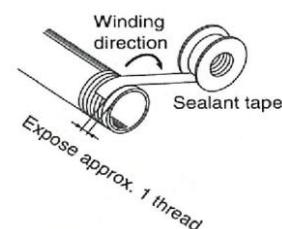

Precautions for One-Touch Tube Fittings

Mounting/ Piping

⚠ Caution

(1) Connection and disconnection of tube from one-touch fitting

① Installation of tube

1) Cut the tube perpendicularly, being careful not to damage the external surface. Use an SMC tube cutter TK-1, 2, 3. Do not cut the tubing with pliers, nippers, scissors, etc., otherwise the tubing will be deformed and problems may result.

2) The outside diameter of the polyurethane tubing swells when internal pressure is applied to it. Therefore, it may be impossible to re-insert the tubing into One-touch fittings. Check the tubing outside diameter, and when the accuracy of the outside diameter is +0.07mm or larger for $\phi 2$, and +0.15mm or larger for other sizes, re-insert it into the One-touch fitting without cutting the tube. When the tubing is re-inserted into the One-touch fitting, confirm that the tubing goes through the release button smoothly.

3) Grasp the tubing, and slowly push it straight into the One-touch fitting until it comes to a stop.

4) Pull the tubing back gently to make sure it has a positive seal. Insufficient installation may cause air to leak or the tubing to release.

② Removal of the tube

1) Push the release button flange evenly and sufficiently to release the tube. Do not push in the tubing before pressing the release button.

2) Pull out the tubing while keeping the release button depressed. If the release button is not held down sufficiently, the tubing cannot be withdrawn.

3) To reuse the tubing, remove the previously lodged portion of the tubing. If the lodged portion is left on without being removed, it may result in air leakage and make the removal of the tubing difficult.

(2) Connection of the metal rod accessories

Do not use tube, resin plug, reducer, etc. after connecting a fitting with a metal rod (KC series, etc.) to a One-touch fitting. This can cause the disconnection of tube.

(3) When mounting the tube, resin plug or metal rod, do not press the release button.

Do not press the release button unnecessarily before mounting tubing, resin plugs and metal rods. This can cause the disconnection of tube.

Recommended Piping Conditions

(1) When connecting piping to the One-touch fitting, use a pipe length with sufficient margin, in accordance with the piping conditions shown in Figure 1.

Also, when using a tying band, etc., to bind the piping together, make sure that external force does not come to bear on the fitting.

(see Figure 2)

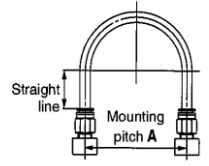
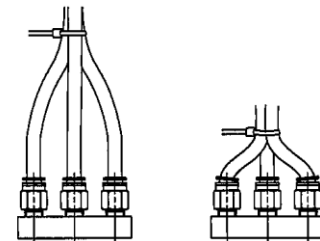

Figure 1 Recommended piping

Unit: mm

tubing size	Mounting pitch A			Straight-line Pipe length
	Nylon tube	Soft nylon tube	Polyurethane tube	
$\phi 3.2$, $\phi 1/8"$	44 or more	35 or more	25 or more	16 or more
$\phi 4$, $\phi 5/32"$	56 or more	44 or more	26 or more	20 or more
$\phi 3/16"$	67 or more	52 or more	38 or more	24 or more
$\phi 6$	84 or more	66 or more	39 or more	30 or more
$\phi 1/4"$	89 or more	70 or more	57 or more	32 or more



Recommended

Not recommended

Fig. 2 When using a tying band to bind the piping together

Air Supply

⚠ Warning

(1) Type of fluids

Please consult with SMC when using the product in applications other than compressed air.

(2) When there is a large amount of drainage

Compressed air containing a large amount of drainage can cause the malfunction of pneumatic equipment. An air dryer or water separator should be installed upstream from filters.

(3) Drain flushing

If condensation in the drain bowl is not emptied on a regular basis, the bowl will overflow and allow the condensation to enter the compressed air lines. This causes the malfunction of pneumatic equipment. If the drain bowl is difficult to check and remove, the installation of a drain bowl with an auto drain option is recommended. For compressed air quality, refer to SMC catalog "Compressed Air Purification System".

Air Supply

Warning

(4) Use clean air

Do not use compressed air that contains chemicals, synthetic oils that include organic solvents, salt, corrosive gases, etc., as it can cause damage or malfunction.

Caution

(1) Install an air filter.

Install an air filter upstream near the valve. Select an air filter with a filtration size of 5 μ m or smaller.

(2) Take measures to ensure air quality, such as by installing an aftercooler, air dryer, or water separator.

Compressed air that contains a large amount of drainage can cause the malfunction of pneumatic equipment, such as flow control equipment. Therefore, take appropriate measures to ensure air quality, such as by providing an aftercooler, air dryer, or water separator.

(3) Ensure that the fluid and ambient temperatures are within the specified range.

If the fluid temperature is 5 °C or less, the moisture in the circuit could freeze, causing damage to the seals or leading to equipment malfunction. Therefore, take appropriate measures to prevent freezing.

For compressed air quality, refer to SMC catalog "Compressed Air Purification System".

Operating environment

Warning

(1) Do not use in an atmosphere containing corrosive gases, chemicals, sea water, water, water steam, or where there is direct contact with any of these.

(2) Do not expose the product to direct sunlight for an extended period of time.

(3) Do not use in a place subject to heavy vibration and/or shock.

(4) Do not mount the product in locations where it is exposed to radiant heat.

Maintenance

Warning

(1) Perform maintenance and inspection according to the procedures indicated in the operation manual.

If handled improperly, malfunction or damage of machinery and equipment may occur.

(2) Maintenance work

If handled improperly, compressed air can be dangerous. Assembly, handling, repair and element replacement of pneumatic systems should be performed by a knowledgeable and experienced person.

(3) Drain flushing

Remove drainage from air filters regularly.

(4) Removal of equipment, and supply/exhaust of compressed air

Before components are removed, first confirm that measures are in place to prevent workpieces from dropping, run-away equipment, etc. Then, Cut the supply pressure and electric power, and exhaust all compressed air from the system using the residual pressure release function.

When machinery is restarted, proceed with caution after confirming that appropriate measures are in place to prevent sudden movement.

3. Application

This product is designed to control the speed of a pneumatic actuator.

4. Specifications

Fluid	Air
Proof pressure	1.05 MPa
Maximum operating pressure	0.7 MPa
Minimum operating pressure	0.05 MPa
Ambient and fluid temperature	-5 to 60°C (No freezing)
Applicable tube materials ^(note 1)	Nylon, soft nylon, polyurethane, FEP, PFA

Note1: Pay attention to the maximum operating pressure for soft nylon and polyurethane.

5. Troubleshooting

Trouble	Possible causes	Countermeasure
Speed(flow) cannot be adjusted.	Dust inside.	Fully open the needle and apply air blow from the free flow side. If the problem is not solved even after air blow, install an air filter to the piping, and replace the product with a new one.
Air leaks from the One-touch fitting. Or the tubing disconnects.	Tubing has been cut using pliers or nipper.	Use tube cutters.
	The tolerance of the outside diameter of the tubing is outside of the specification.	If tubings made by manufacturers other than SMC are used, check the accuracy of the tubing's outside diameter. Nylon tube: Within +/-0.1 mm Soft nylon tube: Within +/-0.1 mm Polyurethane tube: Within -0.2 to +0.15 mm

6. Construction

Seal method: Gasket seal
For M3, M5, 10-32UNF

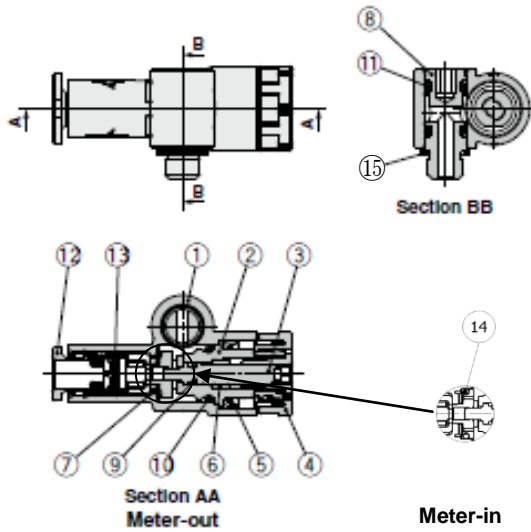

Seal method: Sealant
For R, NPT thread

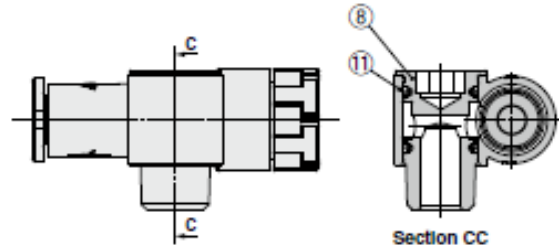

Seal method: Face seal
For G thread

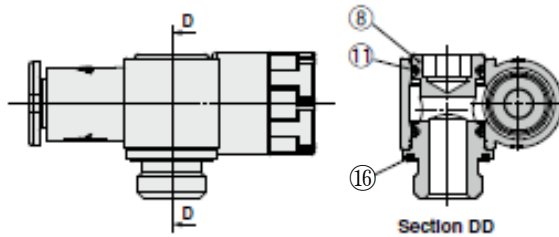

Component Parts			
No.	Description	Material	Note
1	Body A	PBT	
2	Body B	PBT	
3	Needle	PBT	
4	Knob	POM	
5	Stopper	Stainless steel	
6	Needle guide	Brass	Electroless nickel plated
7	Disk seal	HNBR	
8	Stud	Brass	Electroless nickel plated
9	O-ring	NBR	
10	O-ring	NBR	
11	O-ring	NBR	
12	Cassette	-	
13	Seal	NBR	
14	O-ring	NBR	Only Meter-in
15	Gasket	NBR/Stainless steel	
16	Seal	NBR	

Revision history

SMC Corporation

4-14-1, Sotokanda, Chiyoda-ku, Tokyo 101-0021 JAPAN

Tel: + 81 3 5207 8249 Fax: +81 3 5298 5362

URL <https://www.smcworld.com>

Note: Specifications are subject to change without prior notice and any obligation on the part of the manufacturer.
© 2019 SMC Corporation All Rights Reserved